

GENERAL DESCRIPTION

The SGM2201 is a low power linear regulator that supplies power to systems with high input voltages. It features a wide 2.7V to 36V input voltage range, low dropout voltage and low quiescent supply current.

The SGM2201 provides excellent line transient response and 55dB power supply rejection ratio (PSRR). The SGM2201 output voltage can be set externally from 0.8V to 13.2V through a simple resistor divider network.

The SGM2201 also includes thermal shutdown and short circuit protection. It is available in Green TSOT-23-5 and TDFN-2×3-8L packages. It is rated over the -40°C to +85°C temperature range.

FEATURES

- 2.7V to 36V Input Voltage Range
- 4.2μA Quiescent Supply Current
- Adjustable Output Voltages: 0.8V to 13.2V
- 150mA Nominal Output Current
- Output Voltage Accuracy: ±2.5%
- Thermal Shutdown Protection
- -40°C to +85°C Operating Temperature Range
- Available in Green TSOT-23-5 and TDFN-2×3-8L Packages

APPLICATIONS

- Notebook Computers
- Smart-Battery Packs
- PDA's
- Handheld Devices
- Battery-Powered Systems

TYPICAL APPLICATION

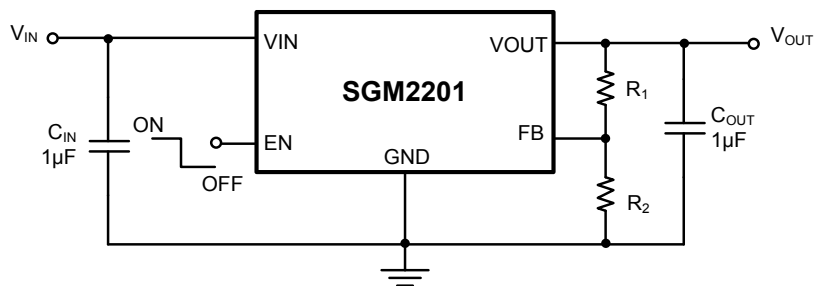

Figure 1. Typical Application Circuit

PACKAGE/ORDERING INFORMATION

MODEL	V _{OUT} (V)	PACKAGE DESCRIPTION	ORDERING NUMBER	MARKING INFORMATION	PACKAGE OPTION
SGM2201	Adjustable	TSOT-23-5	SGM2201-ADJYTN5G/TR	SVDXX	Tape and Reel, 3000
	Adjustable	TDFN-2×3-8L	SGM2201-ADJYTDC8G/TR	SXE XXXX	Tape and Reel, 3000

NOTE: XX = Date Code, XXXX = Date Code.

Green (RoHS & HSF): SG Micro Corp defines "Green" to mean Pb-Free (RoHS compatible) and free of halogen substances. If you have additional comments or questions, please contact your SGMICRO representative directly.

MARKING INFORMATION

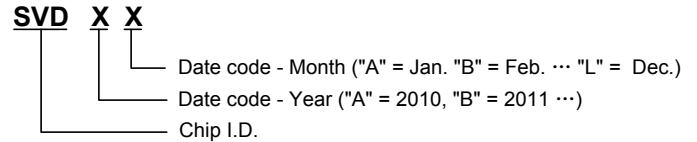

For example: SVDGA (2016, January)

ABSOLUTE MAXIMUM RATINGS

V _{IN} , EN to GND	-0.3V to 44V
V _{OUT} to GND	-0.3V to Min(V _{IN} + 0.3V, 15V)
FB to GND	-0.3V to Min(V _{IN} + 0.3V, 6V)
Power Dissipation, P _D @ T _A = +25°C	
TSOT-23-5	0.510W
TDFN-2×3-8L	1.563W
Package Thermal Resistance	
TSOT-23-5, θ _{JA}	245°C/W
TDFN-2×3-8L, θ _{JA}	80°C/W
Junction Temperature	+150°C
Storage Temperature Range	-65°C to +150°C
Lead Temperature (Soldering, 10s)	+260°C
ESD Susceptibility	
HBM	4000V
MM	200V
CDM	1000V

RECOMMENDED OPERATING CONDITIONS

Input Voltage Range	2.7V to 36V
Operating Temperature Range	-40°C to +85°C

OVERSTRESS CAUTION

Stresses beyond those listed may cause permanent damage to the device. Functional operation of the device at these or any other conditions beyond those indicated in the operational section of the specification is not implied. Exposure to absolute maximum rating conditions for extended periods may affect reliability.

ESD SENSITIVITY CAUTION

This integrated circuit can be damaged by ESD if you don't pay attention to ESD protection. SGMICRO recommends that all integrated circuits be handled with appropriate precautions. Failure to observe proper handling and installation procedures can cause damage. ESD damage can range from subtle performance degradation to complete device failure. Precision integrated circuits may be more susceptible to damage because very small parametric changes could cause the device not to meet its published specifications.

DISCLAIMER

SG Micro Corp reserves the right to make any change in circuit design, specification or other related things if necessary without notice at any time.

PIN CONFIGURATIONS

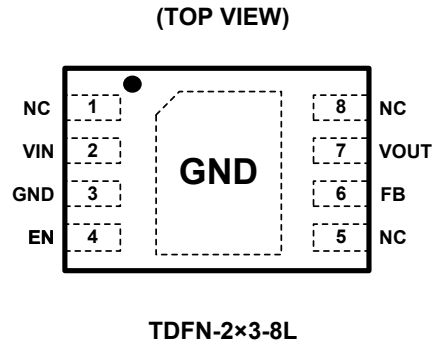
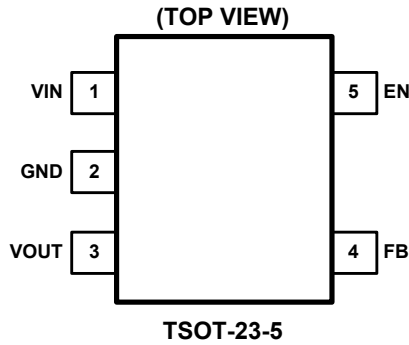

PIN DESCRIPTION

PIN		NAME	FUNCTION
TSOT-23-5	TDFN-2x3-8L		
1	2	VIN	Regulator Input. Up to 36V input voltage. At least 1μF supply bypass capacitor is recommended.
2	3	GND	Ground.
3	7	VOUT	Regulator Output. Recommended output capacitor range: 1μF to 10μF.
4	6	FB	Feedback Pin. This is used to set the output voltage of the device.
5	4	EN	Shutdown Input. Connect to VIN pin for normal operation.
–	1, 5, 8	NC	Not Connected.
–	Exposed Pad	GND	The exposed pad and GND pin must be connected to the same ground plane.

ELECTRICAL CHARACTERISTICS

(V_{IN} = 15V, V_{EN} = 2V, C_{IN} = C_{OUT} = 1μF, Full = -40°C to +85°C, typical values are at T_A = +25°C, unless otherwise noted.)

PARAMETER	SYMBOL	CONDITIONS	TEMP	MIN	TYP	MAX	UNITS
Input Voltage	V _{IN}	V _{OUT} < 3.3V	Full	2.7		32	V
		V _{OUT} ≥ 3.3V	Full	2.7		36	
Output Voltage Accuracy		I _{OUT} = 1mA	+25°C	-2.5		2.5	%
Feedback Voltage	V _{FB}	V _{FB} = V _{OUT} , I _{OUT} = 1mA	+25°C		0.8		V
FB Input Current	I _{FB}	V _{FB} = 0.9V	Full	-15		15	nA
Ground Pin Current		No load	+25°C		4.2	5.4	μA
			Full			6.5	
		I _{OUT} = 50mA	+25°C		4.2		
Maximum Output Current ⁽¹⁾		V _{IN} = V _{OUT} + 2V or 4V, whichever is greater	+25°C	150			mA
Dropout Voltage ⁽²⁾	V _{DROP}	I _{OUT} = 150mA, V _{OUT} ≥ 2.5V	+25°C		1300	1840	mV
			Full			2380	
Line Regulation	$\frac{\Delta V_{OUT}}{\Delta V_{IN} \times V_{OUT}}$	V _{FB} = V _{OUT} = 0.8V, V _{IN} = 4V to 32V, I _{OUT} = 1mA	+25°C		0.005	0.01	%/V
Load Regulation	ΔV _{OUT}	V _{FB} = V _{OUT} = 0.8V, V _{IN} = 4V, I _{OUT} = 1mA to 150mA	+25°C		2	6	mV
Power Supply Rejection Ratio	PSRR	V _{OUT} = 3.3V, I _{OUT} = 10mA	f = 217Hz	+25°C		55	dB
			f = 1kHz	+25°C		40	
Output Voltage Temperature Coefficient ⁽³⁾	$\frac{\Delta V_{OUT}}{\Delta T_A \times V_{OUT}}$	V _{IN} = V _{OUT} + 2V or 4V, I _{OUT} = 1mA	Full		35		ppm/°C
SHUTDOWN							
EN Input Threshold	V _{IH}	V _{IN} = 2.7V to 36V	Full	1.2			V
	V _{IL}		Full			0.4	
EN Input Bias Current	I _{BH}	V _{EN} = V _{IN}	Full		0.02	1	μA
	I _{BL}	V _{EN} = 0V	Full	-1		1	
Shutdown Supply Current	I _{Q(SHDN)}	V _{EN} = 0V	+25°C		1.5	2	μA
Start-Up Time ⁽⁴⁾	t _{STR}	No load	+25°C		5		ms
R _{ON} of Discharge MOSFET		V _{IN} = 2.7V, V _{EN} = 0V, I _{OUT} = -1mA	+25°C		75		Ω
THERMAL PROTECTION							
Thermal Shutdown Temperature	T _{SHDN}				150		°C
Thermal Shutdown Hysteresis	ΔT _{SHDN}				20		°C

NOTES:

- Maximum output current is affected by the PCB layout, size of metal trace, the thermal conduction path between metal layers, ambient temperature and the other environment factors of system. Attention should be paid to the dropout voltage when V_{IN} < V_{OUT} + V_{DROP}.
- The dropout voltage is defined as V_{IN} - V_{OUT}, when V_{OUT} is 95% of the value of V_{OUT} for V_{IN} = V_{OUT} + 2V.
- Output voltage temperature coefficient is defined as the worst-case voltage change divided by the total temperature range.
- Time needed for V_{OUT} to reach 90% of final value.

TYPICAL PERFORMANCE CHARACTERISTICS

$V_{IN} = 5.3V$, $V_{EN} = 2V$, $V_{OUT} = 3.3V$, $C_{IN} = C_{OUT} = 1\mu F$, $T_A = +25^\circ C$, unless otherwise noted.

Load-Transient Response

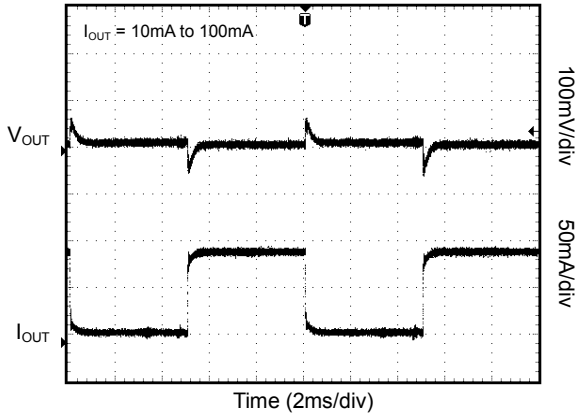

Line-Transient Response

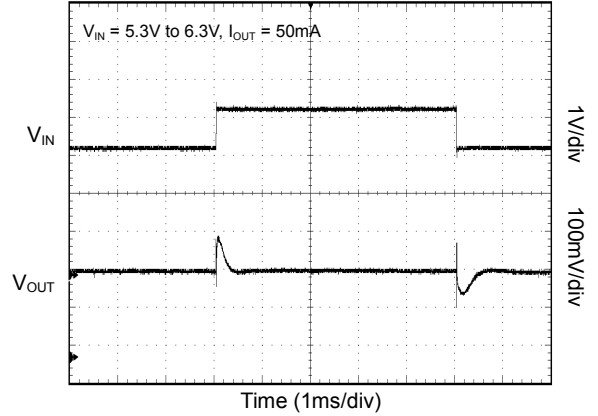

Power-Up/Power-Down Output Waveform

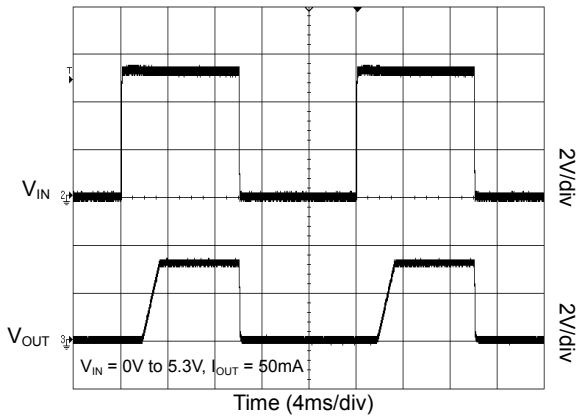

Power Ramp-Up/Ramp-Down Output Waveform

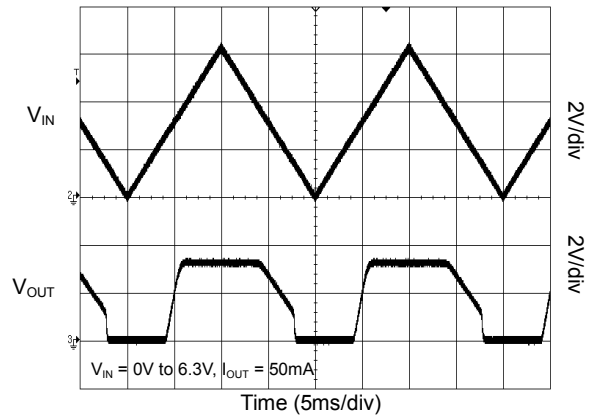

Output Short Waveform

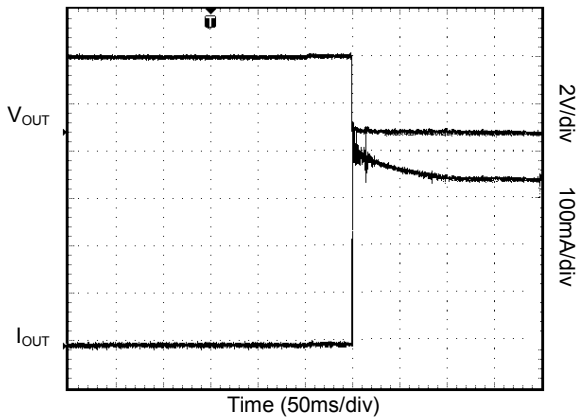

Thermal Protection Waveform

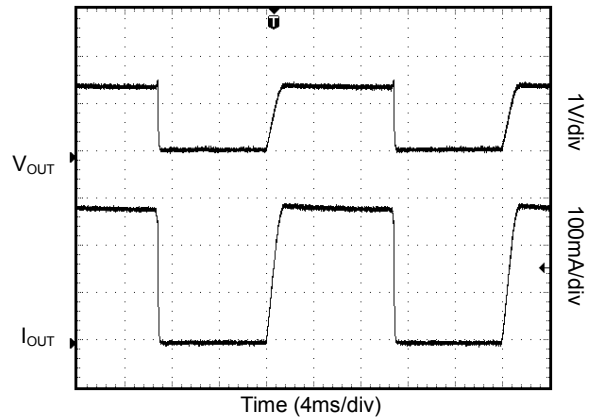

TYPICAL PERFORMANCE CHARACTERISTICS (continued)

$V_{IN} = 5.3V$, $V_{EN} = 2V$, $V_{OUT} = 3.3V$, $C_{IN} = C_{OUT} = 1\mu F$, $T_A = +25^\circ C$, unless otherwise noted.

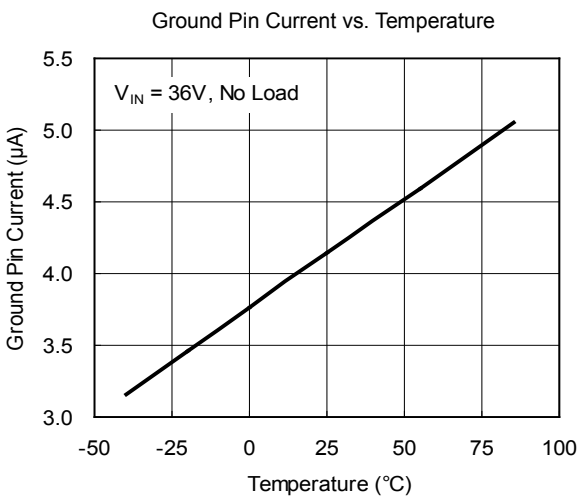
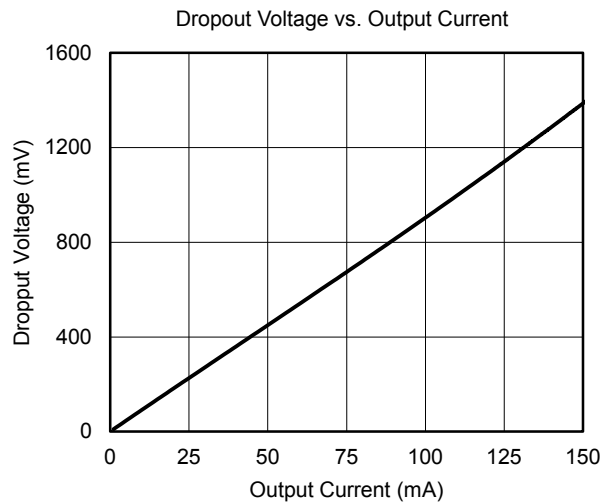
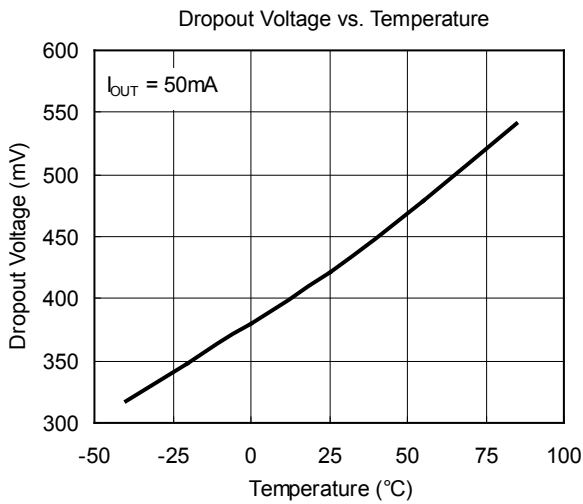
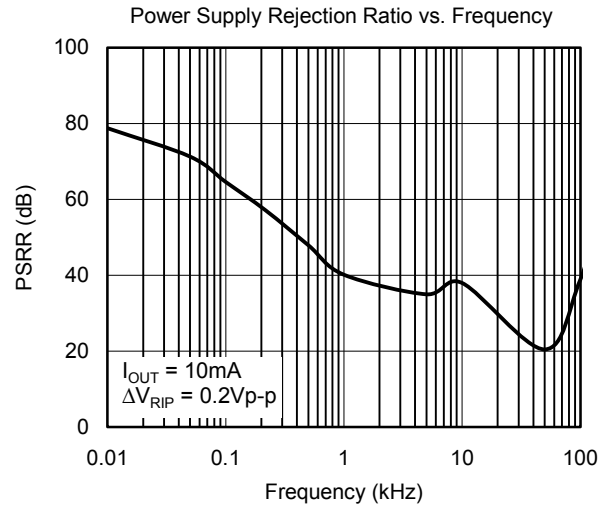
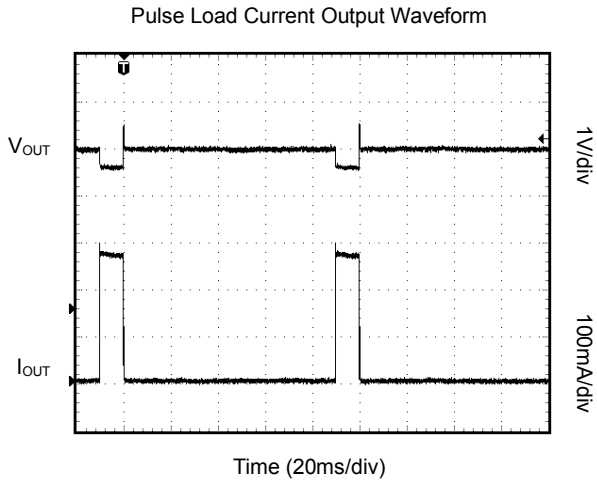

DETAILED DESCRIPTION

The SGM2201 is a linear regulator designed primarily for high input voltage applications. The SGM2201 has an output that is adjustable from 0.8V to 13.2V with a simple resistor divider. The maximum output current is dependent on the package's maximum power dissipation for a given temperature.

The SGM2201 uses external feedback, allowing the user to set the output voltage with an external resistor divider. The typical FB pin voltage is 0.8V.

The IC enters shutdown mode when EN is low. In shutdown mode, the pass transistor and control circuitry are turned off, reducing the supply current to < 2μA. Connect EN to VIN for automatic startup.

APPLICATION INFORMATION

Setting the Output Voltage

Set the output voltage of the SGM2201 by using a resistor divider as shown:

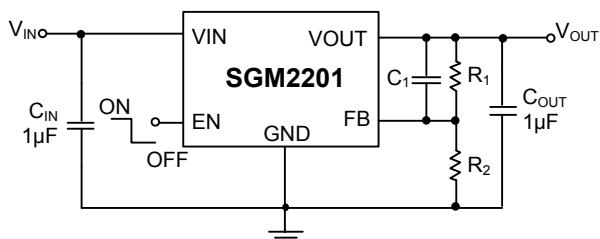

Figure 2. SGM2201 with External Resistor Divider

Choose $R_2 = 2M\Omega$ to maintain a 0.4μA minimum load. Calculate the value for R_1 using the following equation:

$$R_1 = R_2 \times \left(\frac{V_{OUT}}{0.8V} - 1 \right)$$

Input Capacitor and Output Capacitor

For proper operation, place a ceramic capacitor (C_{IN}) between 1μF and 10μF between the input pin and ground. Larger values in this range will help improve line transient response.

For stable operation, use a ceramic capacitor (C_{OUT}) between 1μF and 10μF. Larger values in this range will

help improve load transient response and reduce noise. Output capacitors of other dielectric types may be used, but are not recommended as their capacitance can deviate greatly from their rated value over temperature.

Thermal Considerations

When the junction temperature is too high, the thermal protection circuitry sends a signal to the control logic that will shutdown the IC. The IC will restart when the temperature has sufficiently cooled down.

The maximum power dissipation is dependent on the thermal resistance of the case and the circuit board, the temperature difference between the die junction and the ambient air, and the rate of air flow. The GND pin and Exposed Pad must be connected to the ground plane for proper dissipation.

Output Noise

The SGM2201 will exhibit noise on the output during normal operation. This noise is negligible for most applications. However, in applications that include analog-to-digital converters (ADCs) of more than 12 bits, one needs to consider the ADC's power supply rejection specifications. The feed forward capacitor C_1 across R_1 will significantly reduce the output noise.

REVISION HISTORY

NOTE: Page numbers for previous revisions may differ from page numbers in the current version.

Changes from Original (APRIL 2017) to REV.A

Changed from product preview to production data.....All

PACKAGE OUTLINE DIMENSIONS

TSOT-23-5

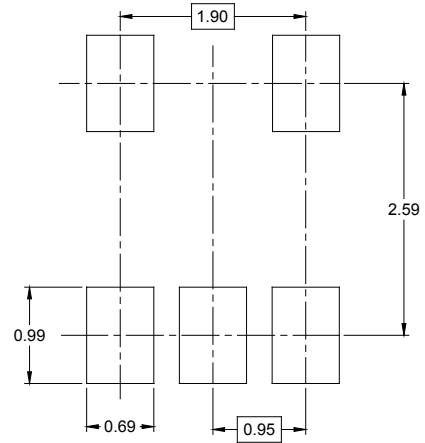
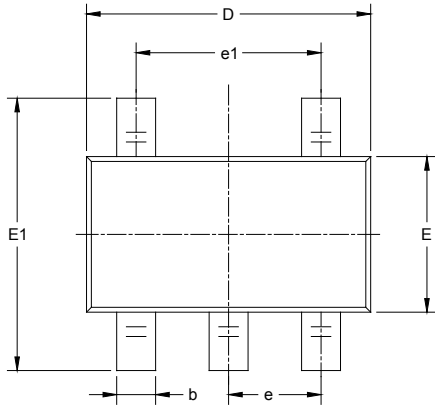

RECOMMENDED LAND PATTERN (Unit: mm)

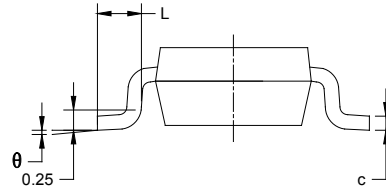
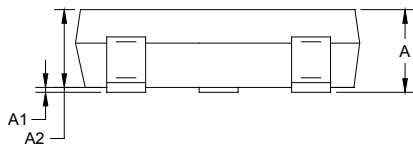

Symbol	Dimensions In Millimeters		Dimensions In Inches	
	MIN	MAX	MIN	MAX
A	0.700	0.900	0.028	0.035
A1	0.000	0.100	0.000	0.004
A2	0.700	0.800	0.028	0.031
b	0.350	0.500	0.014	0.020
c	0.080	0.200	0.003	0.008
D	2.820	3.020	0.111	0.119
E	1.600	1.700	0.063	0.067
E1	2.650	2.950	0.104	0.116
e	0.950 BSC		0.037 BSC	
e1	1.900 BSC		0.075 BSC	
L	0.300	0.600	0.012	0.024
θ	0°	8°	0°	8°

PACKAGE OUTLINE DIMENSIONS

TDFN-2x3-8L

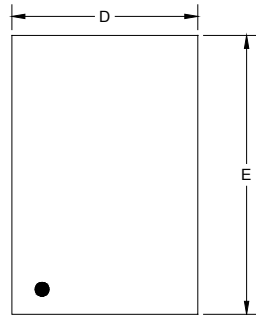

TOP VIEW

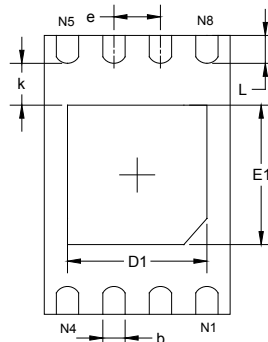

BOTTOM VIEW

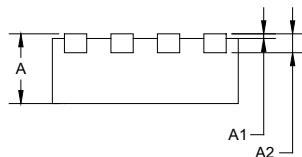

SIDE VIEW

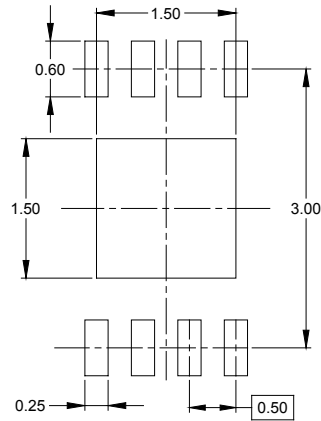

RECOMMENDED LAND PATTERN (Unit: mm)

Symbol	Dimensions In Millimeters		Dimensions In Inches	
	MIN	MAX	MIN	MAX
A	0.700	0.800	0.028	0.031
A1	0.000	0.050	0.000	0.002
A2	0.203 REF		0.008 REF	
D	1.924	2.076	0.076	0.082
D1	1.400	1.600	0.055	0.063
E	2.924	3.076	0.115	0.121
E1	1.400	1.600	0.055	0.063
k	0.200 MIN		0.008 MIN	
b	0.200	0.300	0.008	0.012
e	0.500 TYP		0.020 TYP	
L	0.224	0.376	0.009	0.015

TAPE AND REEL INFORMATION

REEL DIMENSIONS

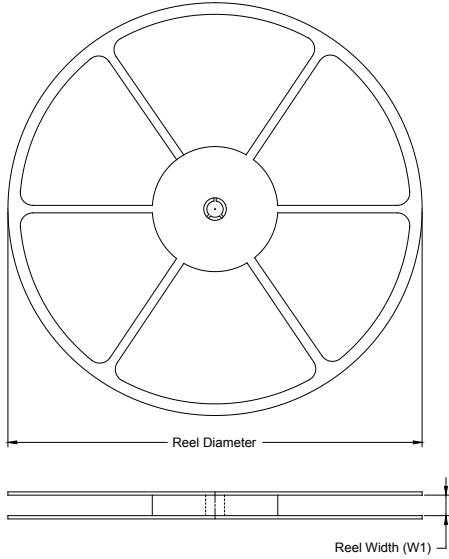

TAPE DIMENSIONS

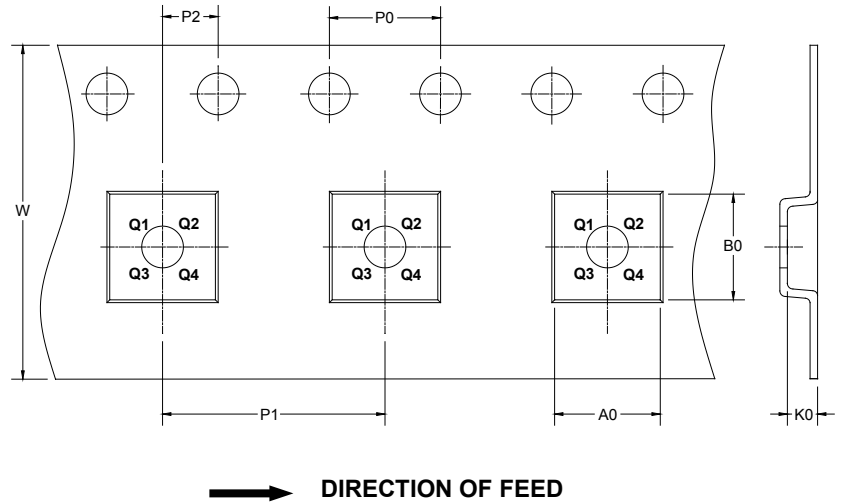

NOTE: The picture is only for reference. Please make the object as the standard.

KEY PARAMETER LIST OF TAPE AND REEL

Package Type	Reel Diameter	Reel Width W1 (mm)	A0 (mm)	B0 (mm)	K0 (mm)	P0 (mm)	P1 (mm)	P2 (mm)	W (mm)	Pin1 Quadrant
TSOT-23-5	7"	9.5	3.17	3.10	1.10	4.0	4.0	2.0	8.0	Q3
TDFN-2×3-8L	7"	9.5	2.30	3.30	1.10	4.0	4.0	2.0	8.0	Q2

DD0001

PACKAGE INFORMATION

CARTON BOX DIMENSIONS



NOTE: The picture is only for reference. Please make the object as the standard.

KEY PARAMETER LIST OF CARTON BOX

Reel Type	Length (mm)	Width (mm)	Height (mm)	Pizza/Carton
7" (Option)	368	227	224	8
7"	442	410	224	18

DD0002