

GENERAL DESCRIPTION

The SGM8042 is guaranteed to operate with a single supply voltage as low as 1.4V, while drawing less than 670nA (TYP) of quiescent current per amplifier. This device is also designed to support rail-to-rail input and output operation. This combination of features supports battery-powered and portable applications.

The SGM8042 has a gain-bandwidth product of 14.5kHz (TYP) and is unity gain stable. These specifications make this operational amplifier appropriate for low frequency applications, such as battery current monitoring and sensor conditioning.

The SGM8042 is offered in dual configuration. It is specified over the extended -40°C to +85°C temperature range. The SGM8042 is available in the Green SOIC-8 and MSOP-8 packages.

TYPICAL APPLICATION

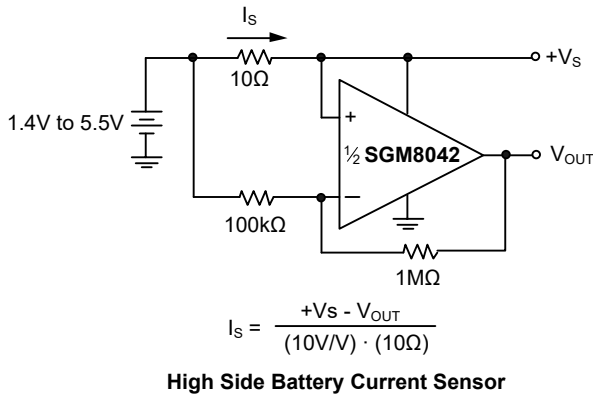

FEATURES

- **Low Quiescent Current: 670nA/Amplifier (TYP)**
- **Rail-to-Rail Input and Output**
- **Gain-Bandwidth Product: 14.5kHz at V_S = 5V (TYP)**
- **Wide Supply Voltage Range: 1.4V to 5.5V**
- **Unity Gain Stable**
- **-40°C to +85°C Operating Temperature Range**
- **Available in Green SOIC-8 and MSOP-8 Packages**

APPLICATIONS

- Toll Booth Tags
- Wearable Products
- Temperature Measurement
- Battery Powered System

PIN CONFIGURATION

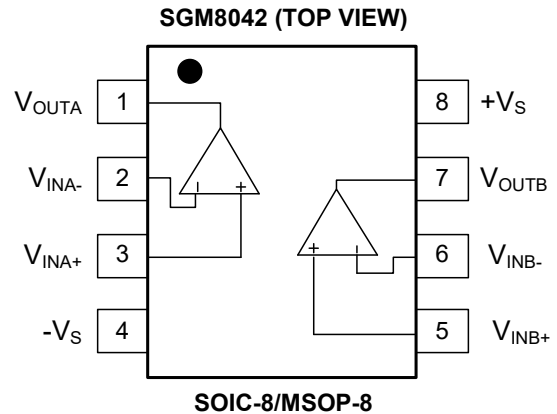

PACKAGE/ORDERING INFORMATION

MODEL	PACKAGE DESCRIPTION	SPECIFIED TEMPERATURE RANGE	ORDERING NUMBER	PACKAGE MARKING	PACKING OPTION
SGM8042	SOIC-8	-40°C to +85°C	SGM8042YS8G/TR	SGM8042YS8 XXXXX	Tape and Reel, 2500
	MSOP-8	-40°C to +85°C	SGM8042YMS8G/TR	SGM8042 YMS8 XXXXX	Tape and Reel, 3000

NOTE: XXXXX = Date Code and Vendor Code.

Green (RoHS & HSF): SG Micro Corp defines "Green" to mean Pb-Free (RoHS compatible) and free of halogen substances. If you have additional comments or questions, please contact your SGMICRO representative directly.

ABSOLUTE MAXIMUM RATINGS

Supply Voltage.....6V
 Analog Inputs (V_{IN+}, V_{IN-})..... (-V_S) - 0.1V to (+V_S) + 0.1V
 Differential Input Voltage.....| (-V_S) - (+V_S) |
 Storage Temperature Range-65°C to +150°C
 Junction Temperature.....+150°C
 Lead Temperature (Soldering 10sec)
+260°C
 ESD Susceptibility
 HBM.....4000V
 MM.....400V

RECOMMENDED OPERATING CONDITIONS

Operating Temperature Range-40°C to +85°C

OVERSTRESS CAUTION

Stresses beyond those listed may cause permanent damage to the device. Functional operation of the device at these or any other conditions beyond those indicated in the operational section of the specification is not implied. Exposure to absolute maximum rating conditions for extended periods may affect reliability.

ESD SENSITIVITY CAUTION

This integrated circuit can be damaged by ESD if you don't pay attention to ESD protection. SGMICRO recommends that all integrated circuits be handled with appropriate precautions. Failure to observe proper handling and installation procedures can cause damage. ESD damage can range from subtle performance degradation to complete device failure. Precision integrated circuits may be more susceptible to damage because very small parametric changes could cause the device not to meet its published specifications.

DISCLAIMER

SG Micro Corp reserves the right to make any change in circuit design, specification or other related things if necessary without notice at any time.

ELECTRICAL CHARACTERISTICS(At $T_A = +25^\circ\text{C}$, $+V_S = 1.4\text{V}$ to 5V , $-V_S = \text{GND}$, $V_{\text{CM}} = +V_S/2$, $V_{\text{OUT}} \approx +V_S/2$ and $R_L = 1\text{M}\Omega$ to $+V_S/2$ ⁽¹⁾, unless otherwise noted.)

PARAMETER	SYMBOL	CONDITIONS	MIN	TYP	MAX	UNITS
DC ELECTRICAL CHARACTERISTICS						
Input Offset Voltage	V_{OS}	$V_{\text{CM}} = +V_S/2$		0.4	2.5	mV
Input Offset Voltage Drift	$\Delta V_{\text{OS}}/\Delta T$	$V_{\text{CM}} = +V_S/2$, $-40^\circ\text{C} \leq T_A \leq +85^\circ\text{C}$		2.5		$\mu\text{V}/^\circ\text{C}$
Power Supply Rejection Ratio	PSRR	$+V_S = 1.4\text{V}$ to 5.5V	77	80		dB
Input Common Mode Voltage Range	V_{CMR}		$-V_S - 0.1$		$+V_S + 0.1$	V
Common Mode Rejection Ratio	CMRR	$+V_S = 5.0\text{V}$, $V_{\text{CM}} = -0.1\text{V}$ to 5.1V	67	84		dB
		$+V_S = 5.0\text{V}$, $V_{\text{CM}} = 2.5\text{V}$ to 5.1V	70	83		
		$+V_S = 5.0\text{V}$, $V_{\text{CM}} = -0.1\text{V}$ to 2.5V	66	78		
Large-Signal Voltage Gain	A_{VO}	$+V_S = 1.4\text{V}$, $R_L = 50\text{k}\Omega$, $V_{\text{OUT}} = +V_S - 0.1\text{V}$	75	80		dB
		$+V_S = 2.5\text{V}$, $R_L = 50\text{k}\Omega$, $V_{\text{OUT}} = +V_S - 0.1\text{V}$		88		
		$+V_S = 5.0\text{V}$, $R_L = 50\text{k}\Omega$, $V_{\text{OUT}} = +V_S - 0.1\text{V}$	84	93		
Input Bias Current	I_{B}			1		pA
Input Offset Current	I_{OS}			1		pA
Maximum Output Voltage Swing	V_{OH}	$+V_S = 1.4\text{V}$, $R_L = 50\text{k}\Omega$	1.390	1.395		V
		$+V_S = 2.5\text{V}$, $R_L = 50\text{k}\Omega$		2.497		
		$+V_S = 5.0\text{V}$, $R_L = 50\text{k}\Omega$	4.990	4.997		
	V_{OL}	$+V_S = 1.4\text{V}$, $R_L = 50\text{k}\Omega$		4.5	10	mV
		$+V_S = 2.5\text{V}$, $R_L = 50\text{k}\Omega$		3.1		
		$+V_S = 5.0\text{V}$, $R_L = 50\text{k}\Omega$		3.5	10	
Short Circuit Current	I_{SC}	$+V_S = 2.5\text{V}$		5.5		mA
		$+V_S = 5.0\text{V}$	22	24		
Supply Voltage	V_{CC}		1.4		5.5	V
Quiescent Current/Amplifier	I_{Q}	$+V_S = 1.4\text{V}$		570		nA
		$+V_S = 2.5\text{V}$		620		
		$+V_S = 5.0\text{V}$		670	1500	

ELECTRICAL CHARACTERISTICS (continued)

(At $T_A = +25^\circ\text{C}$, $+V_S = 1.4\text{V}$ to 5V , $-V_S = \text{GND}$, $V_{CM} = +V_S/2$, $V_{OUT} \approx +V_S/2$ and $R_L = 1\text{M}\Omega$ to $+V_S/2$, $C_L = 60\text{pF}$ ⁽¹⁾, unless otherwise noted.)

PARAMETER	SYMBOL	CONDITIONS	MIN	TYP	MAX	UNITS
AC ELECTRICAL CHARACTERISTICS						
Gain-Bandwidth Product	GBP	$+V_S = 1.4\text{V}$		12		kHz
		$+V_S = 2.5\text{V}$		13.5		
		$+V_S = 5.0\text{V}$		14.5		
Slew Rate	SR	$+V_S = 1.4\text{V}$, $V_{OUT} = 1\text{V}$ Step		3.8		V/ms
		$+V_S = 2.5\text{V}$, $V_{OUT} = 1\text{V}$ Step		4.0		
		$+V_S = 5.0\text{V}$, $V_{OUT} = 2\text{V}$ Step		4.2		
Phase Margin	PM	$+V_S = 1.4\text{V}$ to 5.5V		60		°
Input Voltage Noise	$e_{n,P-P}$	$+V_S = 1.4\text{V}$, $f = 0.1\text{Hz}$ to 10Hz		3.7		μV_{P-P}
		$+V_S = 2.5\text{V}$, $f = 0.1\text{Hz}$ to 10Hz		3.2		
		$+V_S = 5.0\text{V}$, $f = 0.1\text{Hz}$ to 10Hz		3.2		
Input Voltage Noise Density	e_n	$+V_S = 1.4\text{V}$, $f = 1\text{kHz}$		190		$\text{nV}/\sqrt{\text{Hz}}$
		$+V_S = 2.5\text{V}$, $f = 1\text{kHz}$		180		
		$+V_S = 5.0\text{V}$, $f = 1\text{kHz}$		180		

NOTE1: Refer to Figure 1 and Figure 2.

TEST CIRCUITS

The test circuits used for the DC and AC tests are shown in Figure 1 and Figure 2.

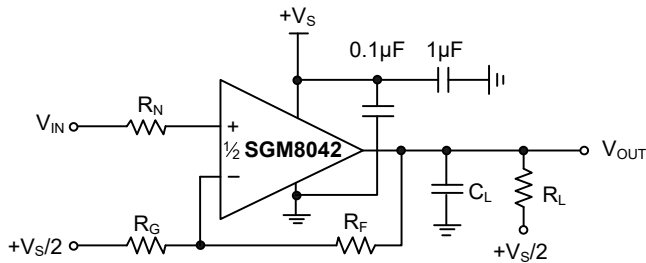

Figure 1. AC and DC Test Circuit for Most Non-Inverting Gain Configurations

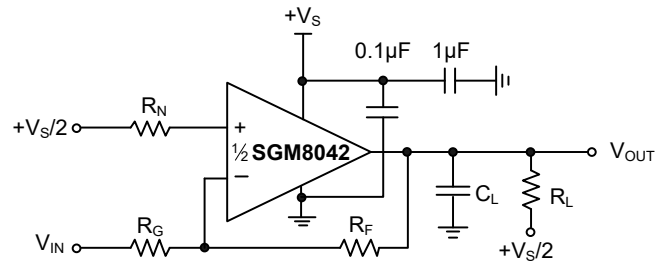
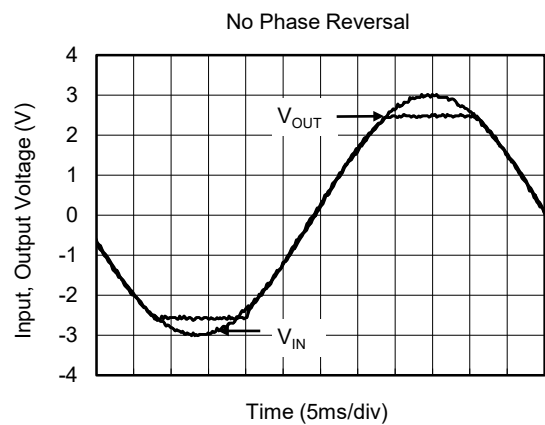
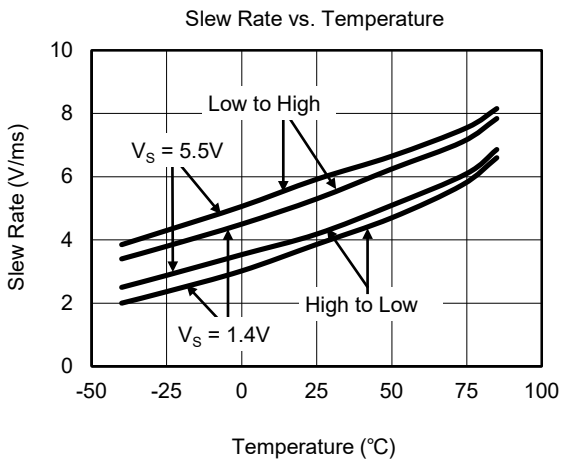
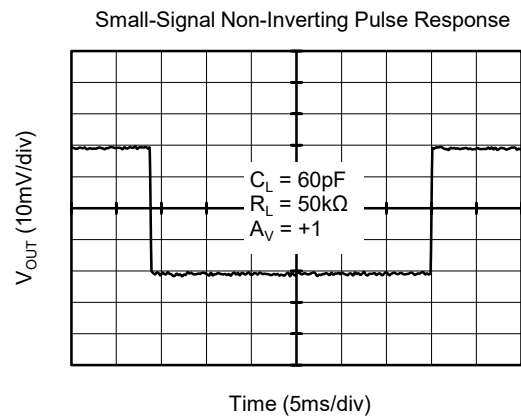
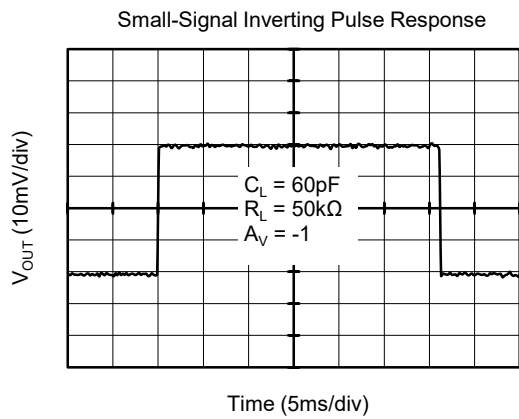
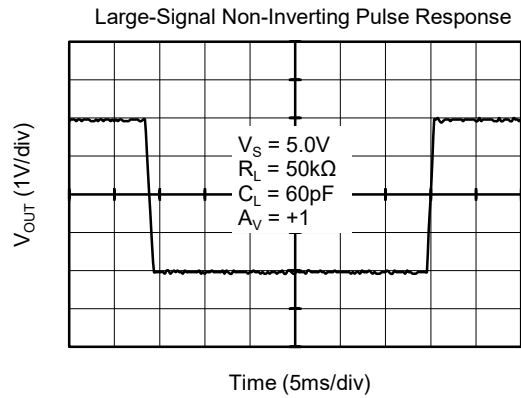
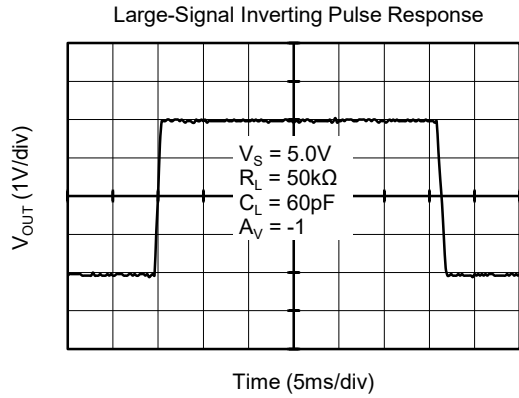

Figure 2. AC and DC Test Circuit for Most Inverting Gain Configurations

TYPICAL PERFORMANCE CHARACTERISTICS

$T_A = +25^\circ\text{C}$, $+V_S = 1.4\text{V to } 5\text{V}$, $-V_S = \text{GND}$, $V_{CM} = +V_S/2$, $V_{OUT} \approx +V_S/2$ and $R_L = 1\text{M}\Omega$ to $+V_S/2$, $C_L = 60\text{pF}$, unless otherwise noted.



TYPICAL PERFORMANCE CHARACTERISTICS (continued)

T_A = +25°C, +V_S = 1.4V to 5V, -V_S = GND, V_{CM} = +V_S/2, V_{OUT} ≈ +V_S/2 and R_L = 1MΩ to +V_S/2, C_L = 60pF, unless otherwise noted.

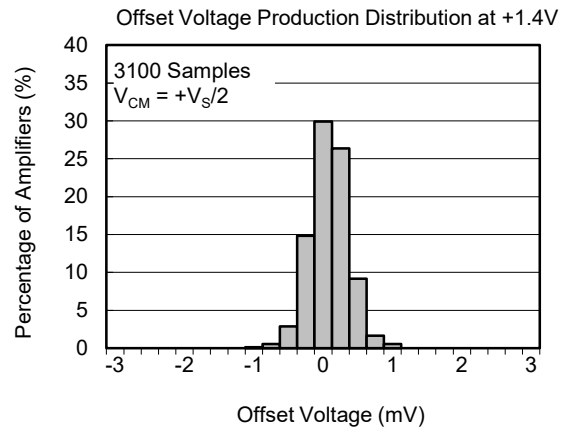
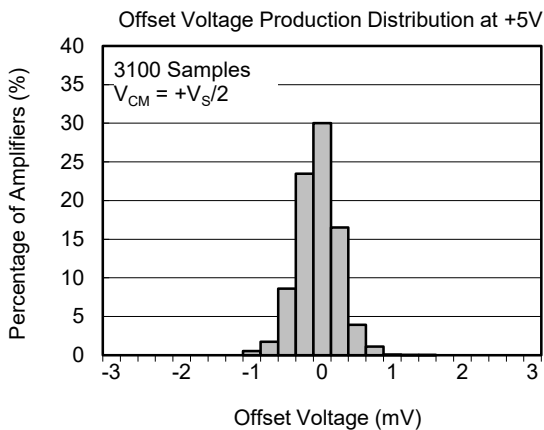
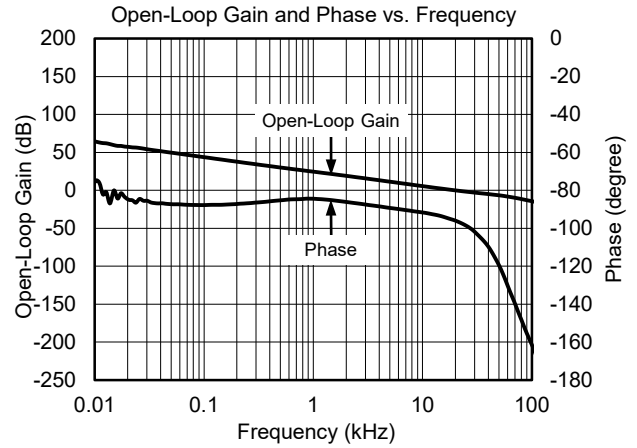
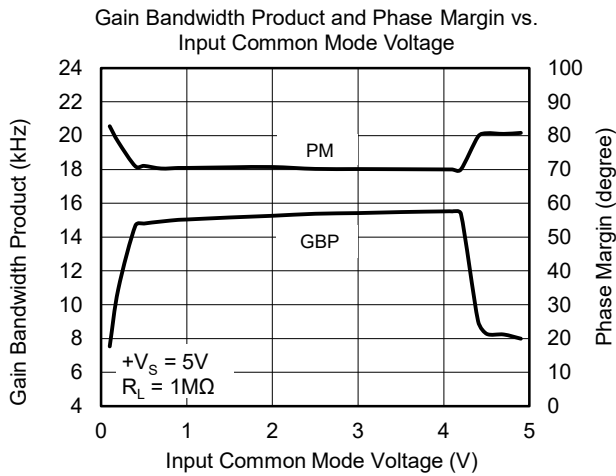

REVISION HISTORY

NOTE: Page numbers for previous revisions may differ from page numbers in the current version.

OCTOBER 2017 – REV.A.2 to REV.A.3

Updated Typical Performance Characteristics section 6

JANUARY 2013 – REV.A.1 to REV.A.2

Added Tape and Reel Information section 9~10

MAY 2011 – REV.A to REV.A.1

Updated Package Description All

Changes from Original (APRIL 2010) to REV.A

Changed from product preview to production data All

PACKAGE OUTLINE DIMENSIONS

SOIC-8

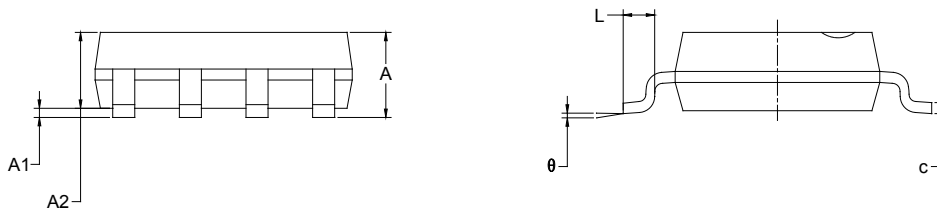
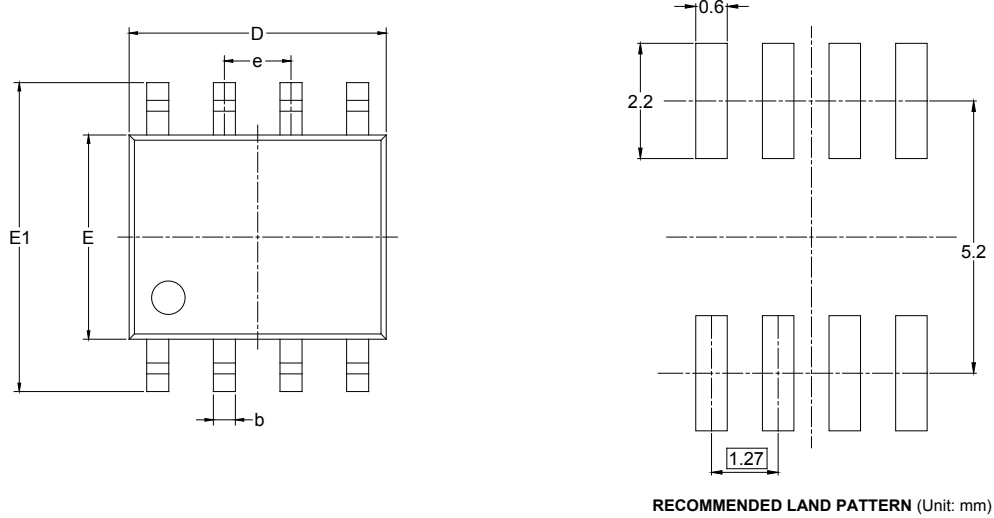

Symbol	Dimensions In Millimeters		Dimensions In Inches	
	MIN	MAX	MIN	MAX
A	1.350	1.750	0.053	0.069
A1	0.100	0.250	0.004	0.010
A2	1.350	1.550	0.053	0.061
b	0.330	0.510	0.013	0.020
c	0.170	0.250	0.006	0.010
D	4.700	5.100	0.185	0.200
E	3.800	4.000	0.150	0.157
E1	5.800	6.200	0.228	0.244
e	1.27 BSC		0.050 BSC	
L	0.400	1.270	0.016	0.050
θ	0°	8°	0°	8°

PACKAGE OUTLINE DIMENSIONS

MSOP-8

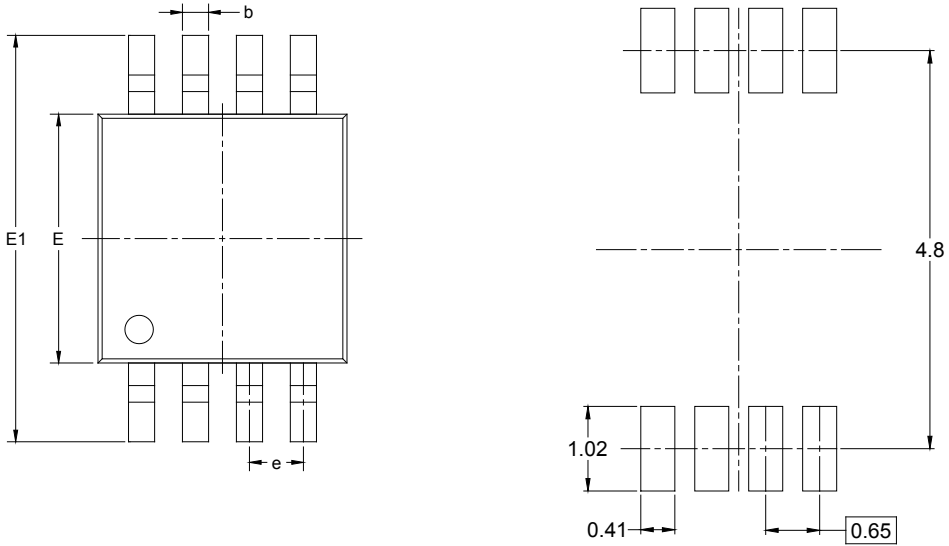

RECOMMENDED LAND PATTERN (Unit: mm)

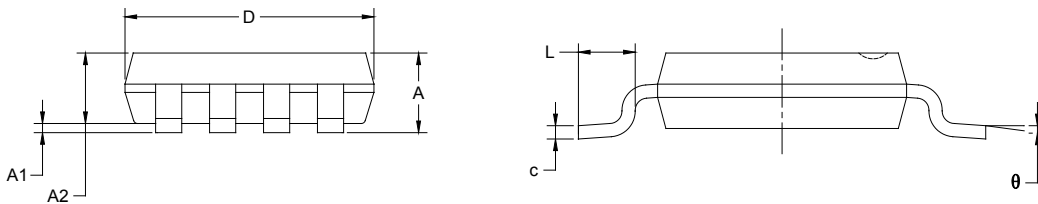

Symbol	Dimensions In Millimeters		Dimensions In Inches	
	MIN	MAX	MIN	MAX
A	0.820	1.100	0.032	0.043
A1	0.020	0.150	0.001	0.006
A2	0.750	0.950	0.030	0.037
b	0.250	0.380	0.010	0.015
c	0.090	0.230	0.004	0.009
D	2.900	3.100	0.114	0.122
E	2.900	3.100	0.114	0.122
E1	4.750	5.050	0.187	0.199
e	0.650 BSC		0.026 BSC	
L	0.400	0.800	0.016	0.031
θ	0°	6°	0°	6°

PACKAGE INFORMATION

TAPE AND REEL INFORMATION

REEL DIMENSIONS

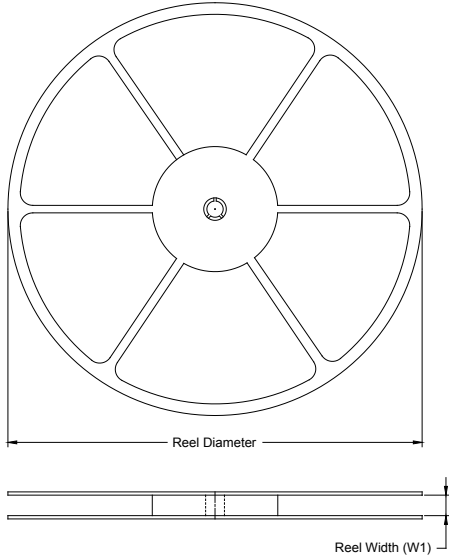

TAPE DIMENSIONS

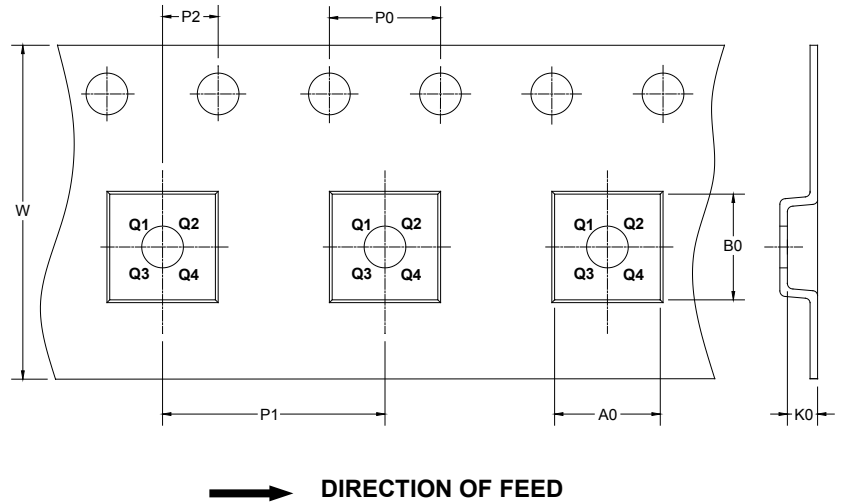

NOTE: The picture is only for reference. Please make the object as the standard.

KEY PARAMETER LIST OF TAPE AND REEL

Package Type	Reel Diameter	Reel Width W1 (mm)	A0 (mm)	B0 (mm)	K0 (mm)	P0 (mm)	P1 (mm)	P2 (mm)	W (mm)	Pin1 Quadrant
SOIC-8	13"	12.4	6.40	5.40	2.10	4.0	8.0	2.0	12.0	Q1
MSOP-8	13"	12.4	5.20	3.30	1.50	4.0	8.0	2.0	12.0	Q1

DD0001

PACKAGE INFORMATION

CARTON BOX DIMENSIONS



NOTE: The picture is only for reference. Please make the object as the standard.

KEY PARAMETER LIST OF CARTON BOX

Reel Type	Length (mm)	Width (mm)	Height (mm)	Pizza/Carton
13"	386	280	370	5

DD0002