



# SGM8141

## 380nA, Single Rail-to-Rail I/O Operational Amplifier

### PRODUCT DESCRIPTION

The SGM8141 is guaranteed to operate with a single supply voltage as low as 1.4V, while drawing less than 380nA (TYP) of quiescent current. This device is also designed to support rail-to-rail input and output operation. This combination of features supports battery-powered and portable applications.

The SGM8141 has a gain-bandwidth product of 5kHz (TYP) and is unity gain stable. These specifications make this operational amplifier appropriate for low frequency applications, such as battery current monitoring and sensor conditioning.

The SGM8141 is offered in single configuration. It is specified for the extended industrial (-40°C to +85°C) temperature range. The SGM8141 is available in the Green SOT-23-5, SOIC-8 and MSOP-8 packages.

### TYPICAL APPLICATION

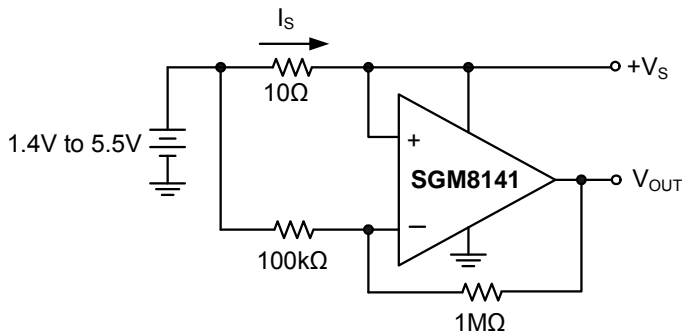

$$I_s = \frac{+V_s - V_{OUT}}{(10V/V) \cdot (10\Omega)}$$

High Side Battery Current Sensor

### FEATURES

- Low Quiescent Current: 380nA (TYP)
- Rail-to-Rail Input and Output
- Gain-Bandwidth Product: 5kHz at  $V_s = 5V$  (TYP)
- Wide Supply Voltage Range: 1.4V to 5.5V
- Unity Gain Stable
- -40°C to +85°C Operating Temperature Range
- Available in Green SOT-23-5, SOIC-8 and MSOP-8 Packages

### APPLICATIONS

Toll Booth Tags  
Wearable Products  
Temperature Measurement  
Battery Powered System

### PIN CONFIGURATIONS (TOP VIEW)

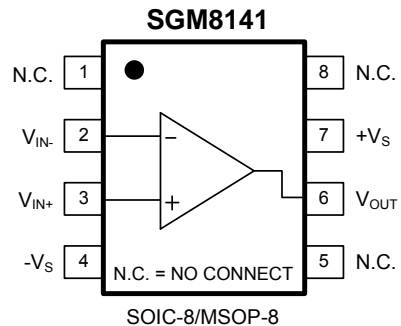
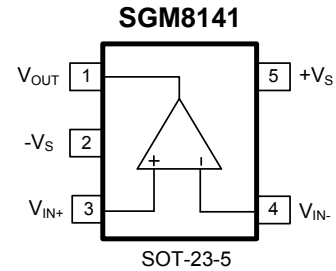

# 380nA, Single Rail-to-Rail I/O Operational Amplifier

## SGM8141

### PACKAGE/ORDERING INFORMATION

MODEL	ORDER NUMBER	PACKAGE DESCRIPTION	PACKAGE OPTION	MARKING INFORMATION
SGM8141	SGM8141YN5G/TR	SOT-23-5	Tape and Reel, 3000	S40XX
	SGM8141YS8G/TR	SOIC-8	Tape and Reel, 2500	SGM8141YS8
	SGM8141YMS8G/TR	MSOP-8	Tape and Reel, 3000	SGM8141YMS8

NOTE: Order number and package marking are defined as the follow:

#### ORDER NUMBER

SGM8141 X X G / TR

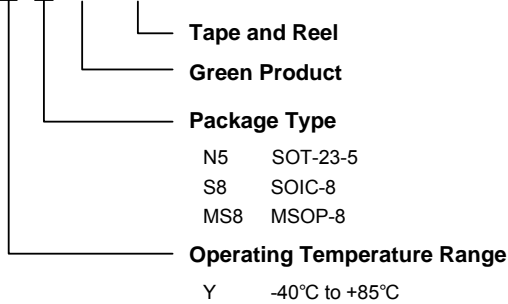

#### MARKING INFORMATION

S40 X X

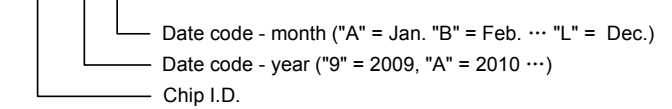

For example: S409A (2009, January)

### ABSOLUTE MAXIMUM RATINGS

Supply Voltage	6V
Analog Inputs ( $V_{IN+}$ , $V_{IN-}$ )	$(-V_S) - 0.1V$ to $(+V_S) + 0.1V$
Differential Input Voltage	$ (-V_S) - (+V_S) $
Storage Temperature Range	-65°C to +150°C
Junction Temperature	150°C
Operating Temperature Range	-40°C to +85°C
Lead Temperature (Soldering 10sec)	
	260°C
ESD Susceptibility	
HBM	3000V
MM	400V

#### NOTE:

Stresses beyond those listed under "Absolute Maximum Ratings" may cause permanent damage to the device. These are stress ratings only, and functional operation of the device at these or any other conditions beyond those indicated in the operational sections of the specifications is not implied. Exposure to absolute maximum rating conditions for extended periods may affect device reliability.

### CAUTION

This integrated circuit can be damaged by ESD if you don't pay attention to ESD protection. SGMICRO recommends that all integrated circuits be handled with appropriate precautions. Failure to observe proper handling and installation procedures can cause damage. ESD damage can range from subtle performance degradation to complete device failure. Precision integrated circuits may be more susceptible to damage because very small parametric changes could cause the device not to meet its published specifications.

SGMICRO reserves the right to make any change in circuit design, specification or other related things if necessary without notice at any time. Please contact SGMICRO sales office to get the latest datasheet.

**ELECTRICAL CHARACTERISTICS**

$+V_S = +1.4V$  to  $+5.0V$ ,  $-V_S = GND$ ,  $T_A = +25^\circ C$ ,  $V_{CM} = +V_S/2$ ,  $V_{OUT} \approx +V_S/2$  and  $R_L = 1M\Omega$  to  $+V_S/2$  <sup>(1)</sup>, unless otherwise noted.

PARAMETER		CONDITIONS	MIN	TYP	MAX	UNITS
<b>DC ELECTRICAL CHARACTERISTICS</b>						
Input Offset Voltage ( $V_{OS}$ )		$V_{CM} = +V_S/2$		0.4	2.5	mV
Input Offset Voltage Drift ( $\Delta V_{OS}/\Delta T$ )		$V_{CM} = +V_S/2$ , $-40^\circ C \leq T_A \leq +85^\circ C$		2		$\mu V/^\circ C$
Power Supply Rejection Ratio (PSRR)		$+V_S = 1.4V$ to $5.5V$	66	80		dB
Input Common Mode Voltage Range ( $V_{CMR}$ )			$-V_S - 0.1$		$+V_S + 0.1$	V
Common Mode Rejection Ratio (CMRR)		$+V_S = 5.0V$ , $V_{CM} = -0.1V$ to $5.1V$	68	80		dB
		$+V_S = 5.0V$ , $V_{CM} = 2.5V$ to $5.1V$	66	80		
		$+V_S = 5.0V$ , $V_{CM} = -0.1V$ to $2.5V$	63	75		
Large Signal Voltage Gain ( $A_{VO}$ )		$+V_S = 1.4V$ , $R_L = 50k\Omega$ , $V_{OUT} = +V_S - 0.1V$	75	80		dB
		$+V_S = 2.5V$ , $R_L = 50k\Omega$ , $V_{OUT} = +V_S - 0.1V$		87		
		$+V_S = 5.0V$ , $R_L = 50k\Omega$ , $V_{OUT} = +V_S - 0.1V$	86	90		
Input Bias Current ( $I_B$ )				1		pA
Input Offset Current ( $I_{OS}$ )				1		pA
Maximum Output Voltage Swing	$V_{OH}$	$+V_S = 1.4V$ , $R_L = 50k\Omega$	1.390	1.395		V
		$+V_S = 2.5V$ , $R_L = 50k\Omega$		2.497		
		$+V_S = 5.0V$ , $R_L = 50k\Omega$	4.990	4.997		
	$V_{OL}$	$+V_S = 1.4V$ , $R_L = 50k\Omega$		4.5	10	mV
		$+V_S = 2.5V$ , $R_L = 50k\Omega$		3.0		
		$+V_S = 5.0V$ , $R_L = 50k\Omega$		3.5	10	
Short Circuit Current ( $I_{SC}$ )		$+V_S = 2.5V$		5.6		mA
		$+V_S = 5.0V$	22	24		
Supply Voltage			1.4		5.5	V
Quiescent Current ( $I_Q$ )		$+V_S = 1.4V$		320		nA
		$+V_S = 2.5V$		350		
		$+V_S = 5.0V$		380	1000	

# SGM8141

# 380nA, Single Rail-to-Rail I/O Operational Amplifier

## ELECTRICAL CHARACTERISTICS

$+V_S = +1.4V$  to  $+5.0V$ ,  $-V_S = GND$ ,  $T_A = +25^\circ C$ ,  $V_{CM} = +V_S/2$ ,  $V_{OUT} \approx +V_S/2$  and  $R_L = 1M\Omega$  to  $+V_S/2$ ,  $C_L = 60pF$  <sup>(1)</sup>, unless otherwise noted.

PARAMETER	CONDITIONS	MIN	TYP	MAX	UNITS
<b>AC ELECTRICAL CHARACTERISTICS</b>					
Gain-Bandwidth Product (GBP)	$+V_S = 1.4V$		4.3		kHz
	$+V_S = 2.5V$		4.7		
	$+V_S = 5.0V$		5		
Slew Rate (SR)	$+V_S = 1.4V, V_{OUT} = 1V$ Step		1.2		V/ms
	$+V_S = 2.5V, V_{OUT} = 1V$ Step		1.4		
	$+V_S = 5.0V, V_{OUT} = 2V$ Step		1.5		
Phase Margin (PM)	$+V_S = 1.4V$ to $5.5V$		60		°
Input Voltage Noise ( $e_n$ , p-p)	$+V_S = 1.4V, f = 0.1Hz$ to $10Hz$		5.0		$\mu V_{P-P}$
	$+V_S = 2.5V, f = 0.1Hz$ to $10Hz$		4.8		
	$+V_S = 5.0V, f = 0.1Hz$ to $10Hz$		4.9		
Input Voltage Noise Density ( $e_n$ )	$+V_S = 1.4V, f = 1kHz$		122		$nV/\sqrt{Hz}$
	$+V_S = 2.5V, f = 1kHz$		123		
	$+V_S = 5.0V, f = 1kHz$		125		

NOTE1: Refer to Figure 1 and Figure 2.

## TEST CIRCUITS

The test circuits used for the DC and AC tests are shown in Figure 1 and Figure 2. The bypass capacitors are laid out according to the rules discussed in "Supply Bypass".

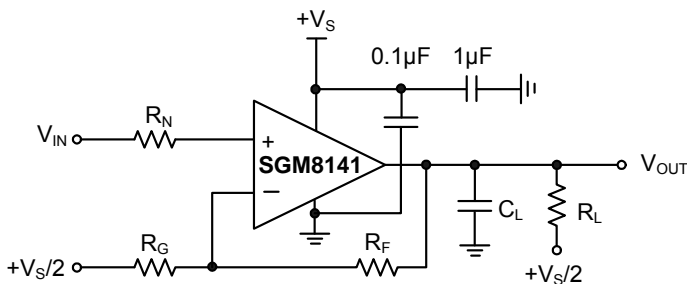

Figure 1. AC and DC Test Circuit for Most Non-Inverting Gain Conditions.

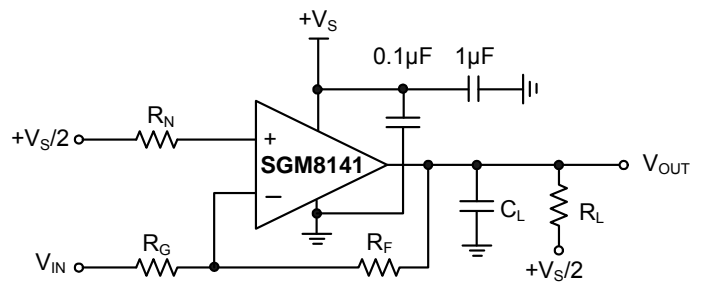
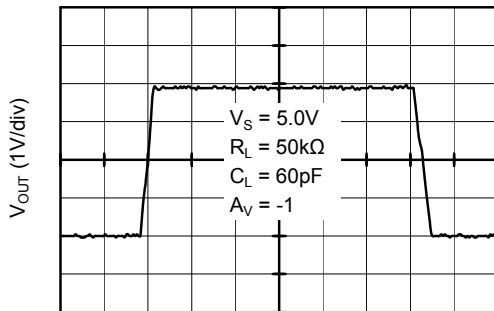

Figure 2. AC and DC Test Circuit for Most Inverting Gain Conditions.

TYPICAL PERFORMANCE CHARACTERISTICS

$T_A = +25^\circ\text{C}$ ,  $+V_S = +1.4\text{V}$  to  $+5.0\text{V}$ ,  $-V_S = \text{GND}$ ,  $V_{\text{CM}} = +V_S/2$ ,  $V_{\text{OUT}} \approx +V_S/2$  and  $R_L = 1\text{M}\Omega$  to  $+V_S/2$ ,  $C_L = 60\text{pF}$ , unless otherwise noted.

Large Signal Inverting Pulse Response



Time (5ms/div)

Large Signal Non-Inverting Pulse Response

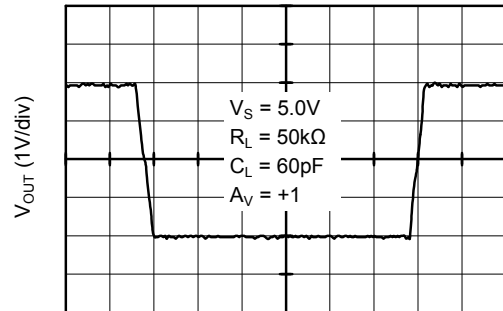

Time (5ms/div)

Small Signal Inverting Pulse Response

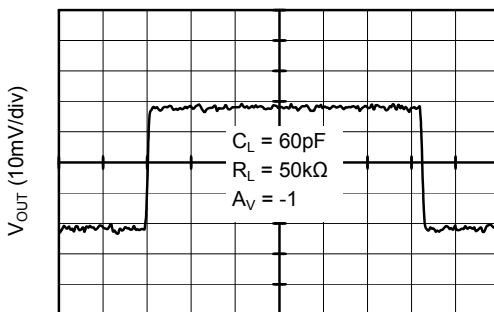

Time (5ms/div)

Small Signal Non-Inverting Pulse Response

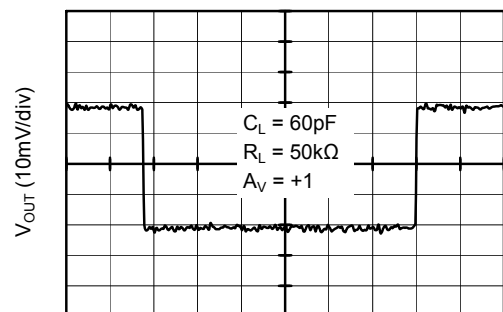

Time (5ms/div)

No Phase Reversal

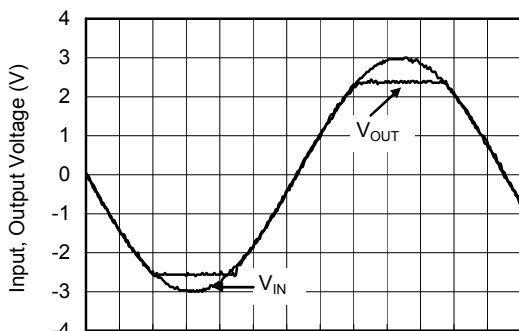

Time (5ms/div)

Slew Rate vs. Temperature

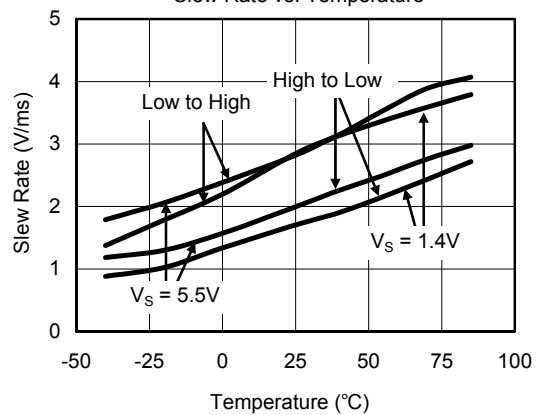

**TYPICAL PERFORMANCE CHARACTERISTICS**

$T_A = +25^\circ\text{C}$ ,  $+V_S = +1.4\text{V}$  to  $+5.0\text{V}$ ,  $-V_S = \text{GND}$ ,  $V_{CM} = +V_S/2$ ,  $V_{OUT} \approx +V_S/2$  and  $R_L = 1\text{M}\Omega$  to  $+V_S/2$ ,  $C_L = 60\text{pF}$ , unless otherwise noted.

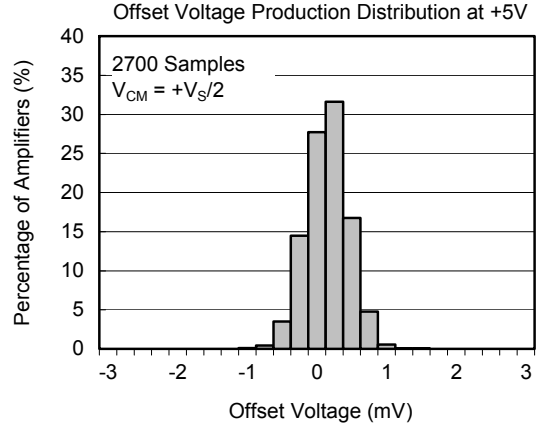
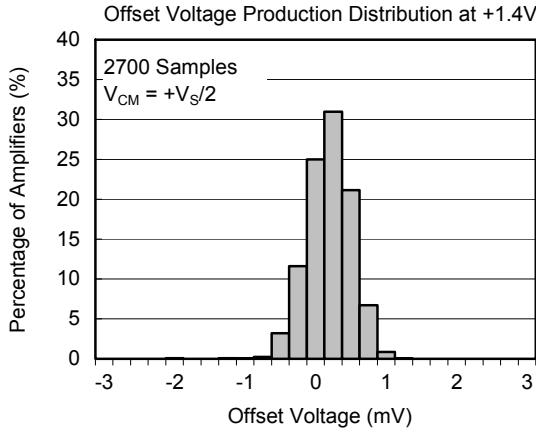

PACKAGE OUTLINE DIMENSIONS

SOT-23-5

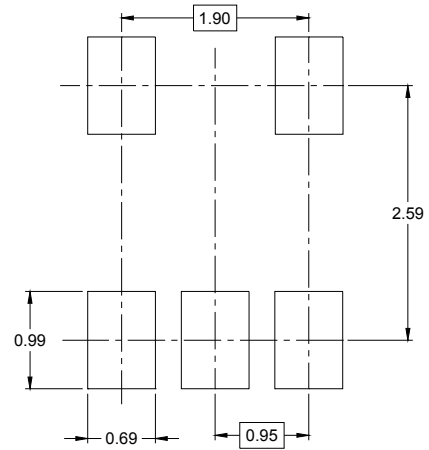
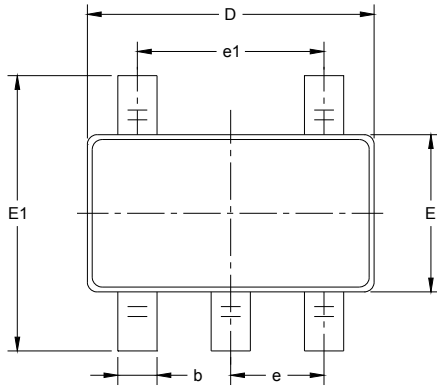

RECOMMENDED LAND PATTERN (Unit: mm)

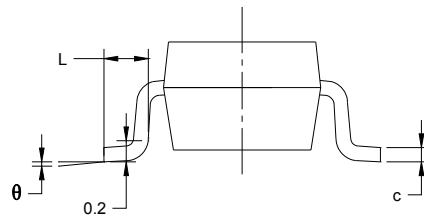
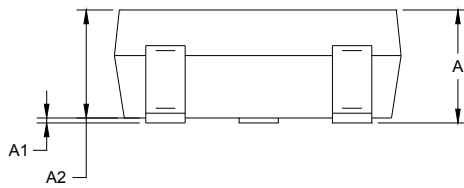

Symbol	Dimensions In Millimeters		Dimensions In Inches	
	MIN	MAX	MIN	MAX
A	1.050	1.250	0.041	0.049
A1	0.000	0.100	0.000	0.004
A2	1.050	1.150	0.041	0.045
b	0.300	0.500	0.012	0.020
c	0.100	0.200	0.004	0.008
D	2.820	3.020	0.111	0.119
E	1.500	1.700	0.059	0.067
E1	2.650	2.950	0.104	0.116
e	0.950 BSC		0.037 BSC	
e1	1.900 BSC		0.075 BSC	
L	0.300	0.600	0.012	0.024
$\theta$	0°	8°	0°	8°

PACKAGE OUTLINE DIMENSIONS

MSOP-8

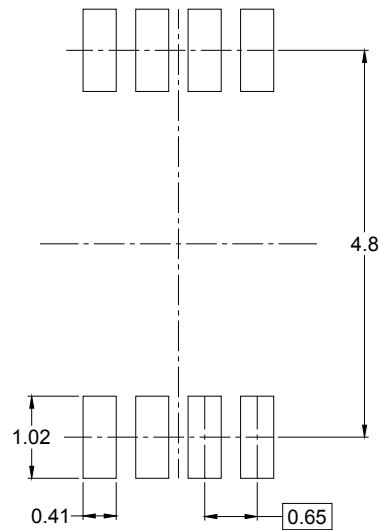
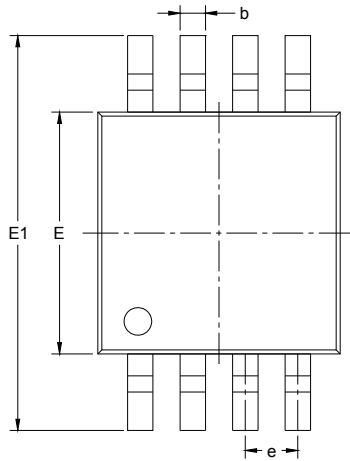

RECOMMENDED LAND PATTERN (Unit: mm)

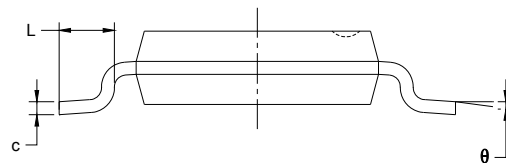
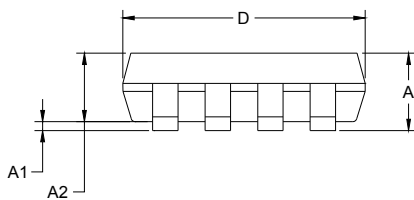

Symbol	Dimensions In Millimeters		Dimensions In Inches	
	MIN	MAX	MIN	MAX
A	0.820	1.100	0.032	0.043
A1	0.020	0.150	0.001	0.006
A2	0.750	0.950	0.030	0.037
b	0.250	0.380	0.010	0.015
c	0.090	0.230	0.004	0.009
D	2.900	3.100	0.114	0.122
E	2.900	3.100	0.114	0.122
E1	4.750	5.050	0.187	0.199
e	0.650 BSC		0.026 BSC	
L	0.400	0.800	0.016	0.031
θ	0°	6°	0°	6°



PACKAGE OUTLINE DIMENSIONS

SOIC-8

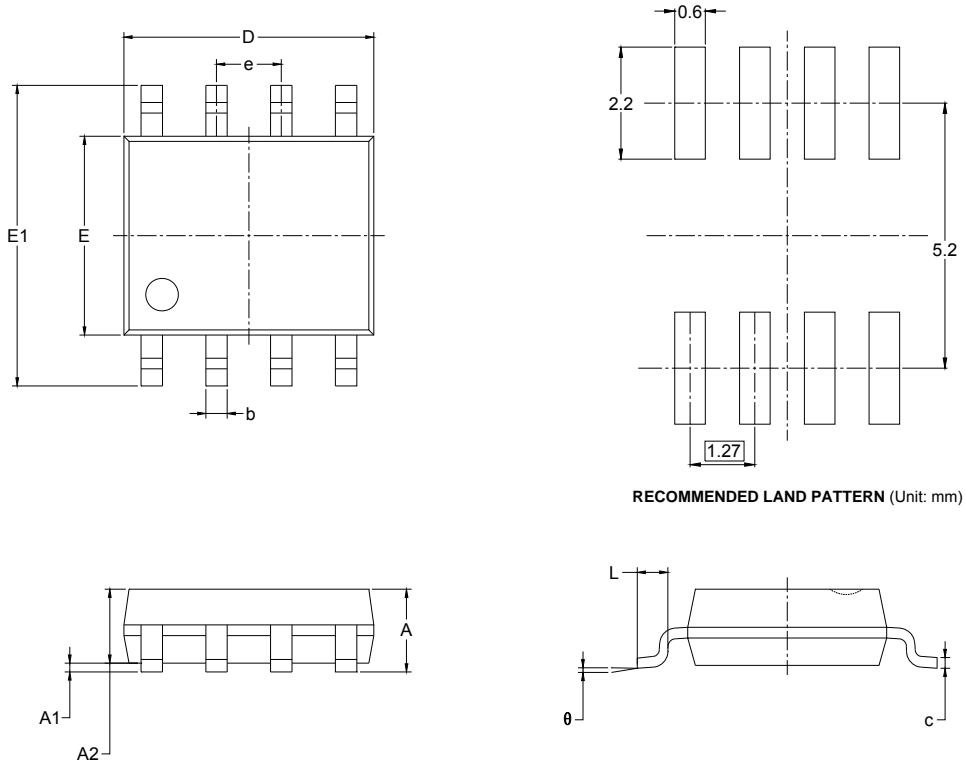

RECOMMENDED LAND PATTERN (Unit: mm)

Symbol	Dimensions In Millimeters		Dimensions In Inches	
	MIN	MAX	MIN	MAX
A	1.350	1.750	0.053	0.069
A1	0.100	0.250	0.004	0.010
A2	1.350	1.550	0.053	0.061
b	0.330	0.510	0.013	0.020
c	0.170	0.250	0.006	0.010
D	4.700	5.100	0.185	0.200
E	3.800	4.000	0.150	0.157
E1	5.800	6.200	0.228	0.244
e	1.27 BSC		0.050 BSC	
L	0.400	1.270	0.016	0.050
$\theta$	0°	8°	0°	8°

**TAPE AND REEL INFORMATION**

**REEL DIMENSIONS**

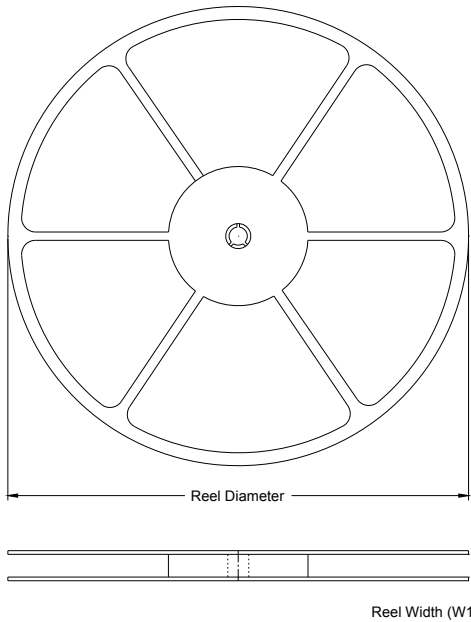

**TAPE DIMENSIONS**

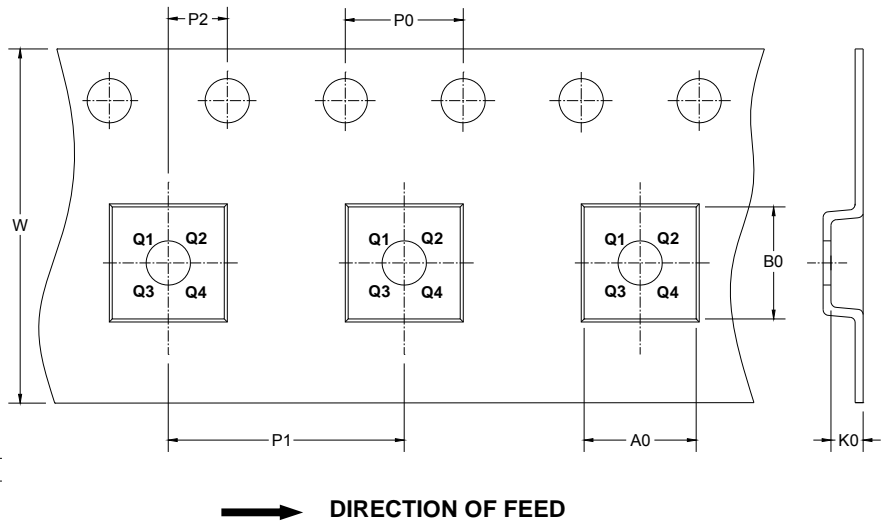

NOTE: The picture is only for reference. Please make the object as the standard.

**KEY PARAMETER LIST OF TAPE AND REEL**

Package Type	Reel Diameter	Reel Width W1 (mm)	A0 (mm)	B0 (mm)	K0 (mm)	P0 (mm)	P1 (mm)	P2 (mm)	W (mm)	Pin1 Quadrant
SOT-23-5	7"	9.5	3.2	3.2	1.4	4.0	4.0	2.0	8.0	Q3
SOIC-8	13"	12.4	6.4	5.4	2.1	4.0	8.0	2.0	12.0	Q1
MSOP-8	13"	12.4	5.2	3.3	1.5	4.0	8.0	2.0	12.0	Q1

**CARTON BOX DIMENSIONS**

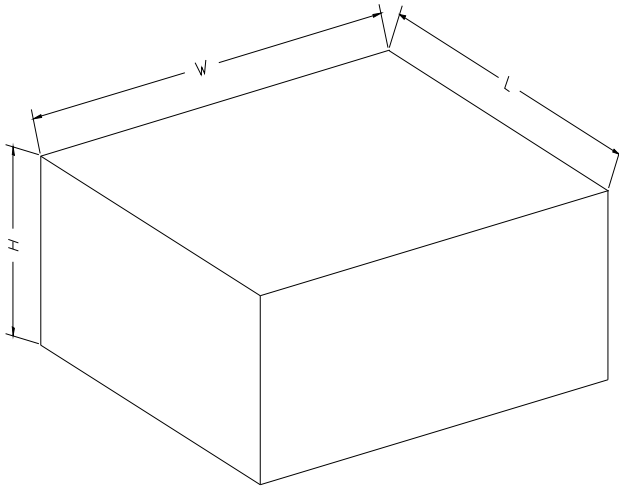

NOTE: The picture is only for reference. Please make the object as the standard.

**KEY PARAMETER LIST OF CARTON BOX**

Reel Type	Length (mm)	Width (mm)	Height (mm)	Pizza/Carton
7" (Option)	368	227	224	8
7"	442	410	224	18
13"	386	280	370	5