

GENERAL DESCRIPTION

The SGM2578A is a small, ultra-low on-resistance load switch with reverse current protection and controlled turn-on. The load switch contains an N-MOSFET that operates over an input voltage range of 1V to 5.5V and can support a maximum continuous current of 2A.

An integrated N-MOSFET offers a low switch R_{ON}. The switch is controlled by ON pin, which is capable of interfacing directly with low voltage control signals. When power is first applied, a smart pull-down is used to keep the ON pin from floating until system sequencing is complete. Once the pin is deliberately driven high (> V_{IH}), the smart pull-down is disconnected to prevent unnecessary power loss. The rise time of the device is controlled internally to avoid inrush current.

The small size and low R_{ON} make the device very suitable for space limited, battery powered applications. The wide input voltage range of the switch makes it a versatile solution for many different voltage rails. The controlled rise time of the device greatly reduces inrush current caused by large bulk load capacitances, thereby reducing or eliminating power supply drop. The SGM2578A further reduces the total solution size by integrating a 280Ω pull-down resistor for quick output discharge (QOD) when the switch is turned off.

The SGM2578A is available in a Green WLCSP-0.9×0.9-4B-A package.

FEATURES

- **Integrated N-MOSFET Load Switch**
- **1V to 5.5V Input Voltage Range**
- **Low On-Resistance**
 - ♦ R_{ON} = 29mΩ at V_{IN} = 4.35V
 - ♦ R_{ON} = 30mΩ at V_{IN} = 3.3V
 - ♦ R_{ON} = 36mΩ at V_{IN} = 1.0V
- **2A Maximum Continuous Switch Current**
- **Low Shutdown Current: 90nA (TYP)**
- **Reverse Current Protection (When Disabled)**
- **Low Threshold 1.8V GPIO Control Input**
- **Bidirectional Power Supply for Power Zone Application**
- **Rise Time:**
 - ♦ SGM2578AAD: 200μs (TYP)
 - ♦ SGM2578ABD: 5000μs (TYP)
- **Quick Output Discharge**
- **Available in a Green WLCSP-0.9×0.9-4B-A Package**

APPLICATIONS

- Smartphone, Mobile Phone
- Ultrathin, Ultrabook/Notebook PC
- Tablet PC, Phablet
- Wearable Technology
- Solid State Drive
- Digital Camera

TYPICAL APPLICATION

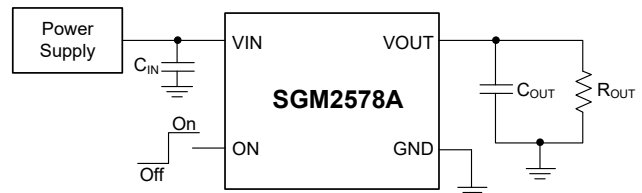

Figure 1. Typical Application Circuit

5.5V, 2A, 30mΩ R_{ON}, Load Switch with SGM2578A Reverse Current Protection and Controlled Turn-On

PACKAGE/ORDERING INFORMATION

MODEL	PACKAGE DESCRIPTION	SPECIFIED TEMPERATURE RANGE	ORDERING NUMBER	PACKAGE MARKING	PACKING OPTION
SGM2578AAD	WLCSP-0.9×0.9-4B-A	-40°C to +85°C	SGM2578AADYG/TR	J7 XX	Tape and Reel, 3000
SGM2578ABD	WLCSP-0.9×0.9-4B-A	-40°C to +85°C	SGM2578ABDYG/TR	J8 XX	Tape and Reel, 3000

MARKING INFORMATION

NOTE: XX = Date Code.

YY — Serial Number

XX

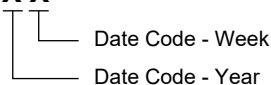

Green (RoHS & HSF): SG Micro Corp defines "Green" to mean Pb-Free (RoHS compatible) and free of halogen substances. If you have additional comments or questions, please contact your SGMICRO representative directly.

ABSOLUTE MAXIMUM RATINGS

Input Voltage Range, V _{IN}	-0.3V to 6V
Output Voltage Range, V _{OUT}	-0.3V to 6V
ON Pin Voltage Range, V _{ON}	-0.3V to 6V
Maximum Continuous Switch Current, I _{MAX}	2A
Maximum Pulsed Switch Current, Pulse < 300μs, 2% Duty Cycle, I _{PLS}	2.5A
Junction Temperature.....	+150°C
Storage Temperature Range.....	-65°C to +150°C
Lead Temperature (Soldering, 10s).....	+260°C
ESD Susceptibility	
HBM.....	4000V
CDM.....	1000V

RECOMMENDED OPERATING CONDITIONS

Input Voltage Range, V _{IN}	1V to 5.5V
Output Voltage Range, V _{OUT}	0V to 5.5V
ON Pin Input High Voltage, V _{IH}	1.2V to 5.5V
ON Pin Input Low Voltage, V _{IL}	0V to 0.4V
Input Capacitance, C _{IN}	1μF
Operating Ambient Temperature Range.....	-40°C to +85°C
Operating Junction Temperature Range.....	-40°C to +125°C

OVERSTRESS CAUTION

Stresses beyond those listed in Absolute Maximum Ratings may cause permanent damage to the device. Exposure to absolute maximum rating conditions for extended periods may affect reliability. Functional operation of the device at any conditions beyond those indicated in the Recommended Operating Conditions section is not implied.

ESD SENSITIVITY CAUTION

This integrated circuit can be damaged if ESD protections are not considered carefully. SGMICRO recommends that all integrated circuits be handled with appropriate precautions. Failure to observe proper handling and installation procedures can cause damage. ESD damage can range from subtle performance degradation to complete device failure. Precision integrated circuits may be more susceptible to damage because even small parametric changes could cause the device not to meet the published specifications.

DISCLAIMER

SG Micro Corp reserves the right to make any change in circuit design, or specifications without prior notice.

PIN CONFIGURATION

(TOP VIEW)

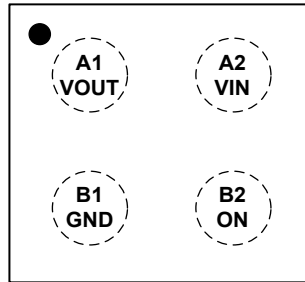

WLCSP-0.9×0.9-4B-A

PIN DESCRIPTION

PIN	NAME	DESCRIPTION
A1	VOUT	Switch Output.
A2	VIN	Switch Input. A bypass capacitor (ceramic) to ground is recommend.
B1	GND	Ground.
B2	ON	Active High Switch Control Input. Do not float this pin.

FUNCTIONAL BLOCK DIAGRAM

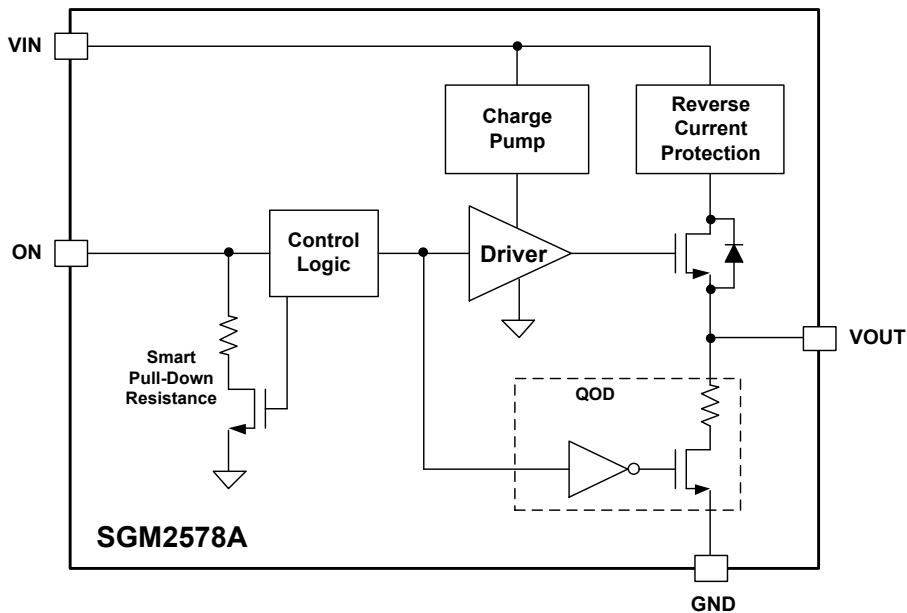

5.5V, 2A, 30mΩ R_{ON}, Load Switch with SGM2578A Reverse Current Protection and Controlled Turn-On

ELECTRICAL CHARACTERISTICS

(V_{IN} = 1V to 5.5V, C_{IN} = 1μF, C_{OUT} = 0.1μF, Full = -40°C to +85°C, typical values are at T_J = +25°C, unless otherwise noted.)

PARAMETER	SYMBOL	CONDITIONS	TEMP	MIN	TYP	MAX	UNITS
Input Voltage Range	V _{IN}		Full	1		5.5	V
Quiescent Current	I _Q	V _{IN} = 5.5V, V _{ON} = 1.2V, I _{OUT} = 0	Full		320	950	nA
		V _{IN} = 3.3V, V _{ON} = 1.2V, I _{OUT} = 0			220	650	
		V _{IN} = 1V, V _{ON} = 1.2V, I _{OUT} = 0			150	500	
Shutdown Current	I _{SD}	V _{IN} = 5.5V, V _{ON} = 0V	Full		90	650	nA
Supply Leakage Current in Shutdown Mode	I _{LEAKAGE}	V _{IN} = 5.5V, V _{ON} = 0V, V _{OUT} = 0V	Full			660	nA
On-Resistance	R _{ON}	V _{IN} = 4.35V, V _{ON} = 1.2V, I _{OUT} = -200mA	Full		29	50	mΩ
		V _{IN} = 3.3V, V _{ON} = 1.2V, I _{OUT} = -200mA			30	50	
		V _{IN} = 1.0V, V _{ON} = 1.2V, I _{OUT} = -200mA			36	57	
ON Pin Hysteresis	V _{HYS}	V _{IN} = 5.5V	Full		34		mV
		V _{IN} = 3.3V	Full		30		
ON Pin Leakage Current	I _{ON}	V _{ON} = 5.5V	Full			670	nA
Reverse Current When Disabled	I _{RC}	V _{IN} = V _{ON} = 0V, V _{OUT} = 5.5V	Full			1	μA
Output Pull-Down Resistance	R _{PD}	V _{IN} = 3.3V, V _{ON} = 0V, I _{OUT} = 2mA	Full		280	400	Ω
Smart Pull-Down Resistance	R _{PD_ON}	Disabled, V _{IN} = 3.3V	+25°C		1200		kΩ
ON Pin Input Low Voltage	V _{IL}		Full			0.4	V
ON Pin Input High Voltage	V _{IH}		Full	1.2			V

5.5V, 2A, 30mΩ R_{ON}, Load Switch with Reverse Current Protection and Controlled Turn-On

SGM2578A

SWITCHING CHARACTERISTICS

(Full = -40°C to +85°C, typical values are at T_J = +25°C, unless otherwise noted.)

PARAMETER	SYMBOL	CONDITIONS	TEMP	MIN	TYP	MAX	UNITS
SGM2578AAD: V_{IN} = 3.3V, T_J = +25°C, unless otherwise noted.							
Turn-On Time	t _{ON}	R _{OUT} = 10Ω, C _{IN} = 1μF, C _{OUT} = 0.1μF, Figure 2 and Figure 3	+25°C		180		μs
Turn-Off Time	t _{OFF}		+25°C		20		
V _{OUT} Rise Time	t _R		Full		200	450	
V _{OUT} Fall Time	t _F		+25°C		3		
Delay Time	t _D		+25°C		130		
SGM2578ABD: V_{IN} = 3.3V, T_J = +25°C, unless otherwise noted.							
Turn-On Time	t _{ON}	R _{OUT} = 10Ω, C _{IN} = 1μF, C _{OUT} = 0.1μF, Figure 2 and Figure 3	+25°C		5000		μs
Turn-Off Time	t _{OFF}		+25°C		20		
V _{OUT} Rise Time	t _R		+25°C		5000		
V _{OUT} Fall Time	t _F		+25°C		3		
Delay Time	t _D		+25°C		2700		

PARAMETER MEASUREMENT INFORMATION

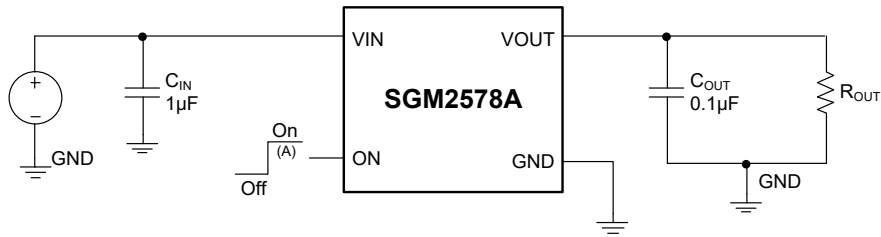

A: Rise and fall times of the control signal are 100ns.

Figure 2. Test Circuit

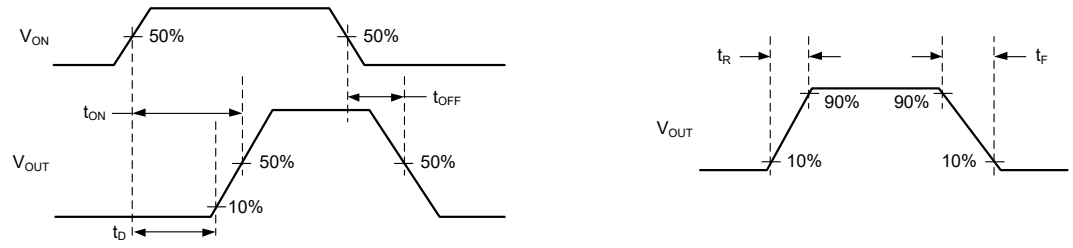
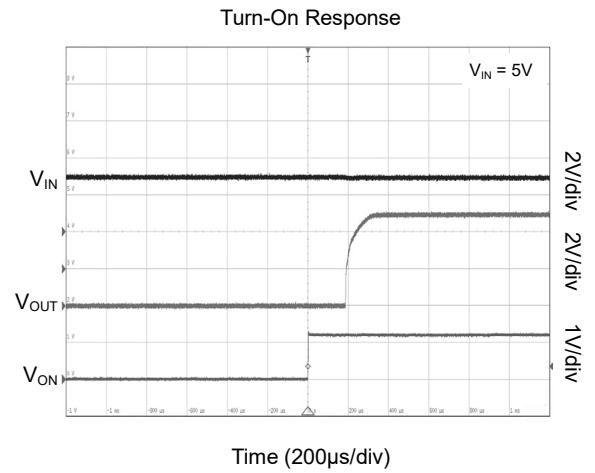
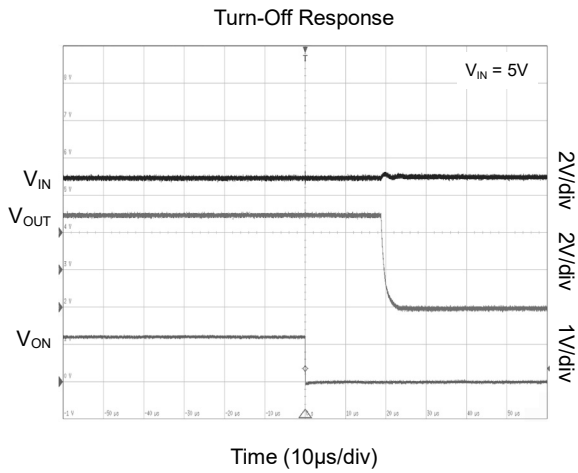
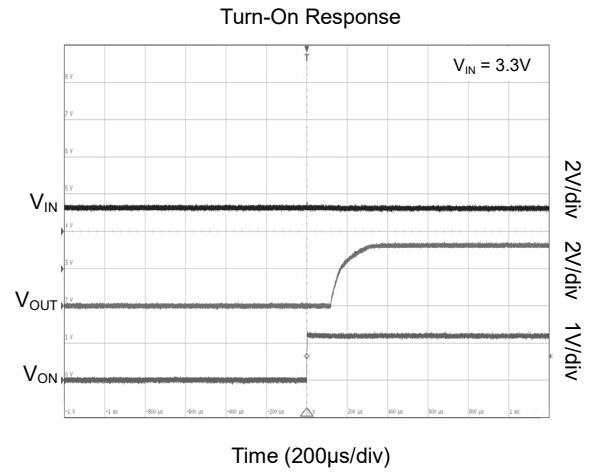
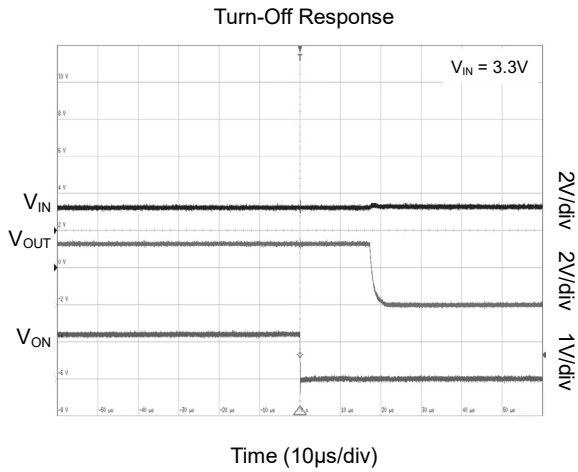
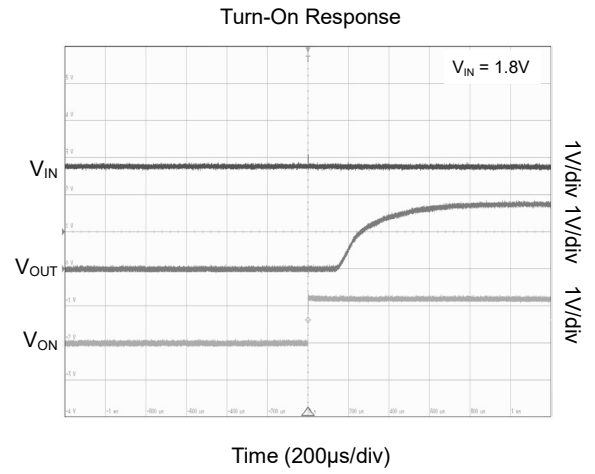
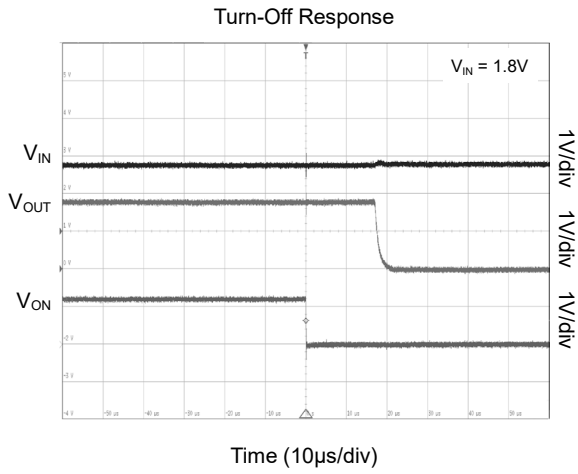

Figure 3. Timing Waveforms

TYPICAL PERFORMANCE CHARACTERISTICS

T_J = +25°C, C_{IN} = 1μF, C_{OUT} = 0.1μF, R_{OUT} = 10Ω, V_{IH} = 1.2V, V_{IL} = 0V, unless otherwise noted.



SGM2578A 5.5V, 2A, 30mΩ R_{ON}, Load Switch with Reverse Current Protection and Controlled Turn-On

TYPICAL PERFORMANCE CHARACTERISTICS (continued)

T_J = +25°C, C_{IN} = 1μF, C_{OUT} = 0.1μF, R_{OUT} = 10Ω, V_{IH} = 1.2V, V_{IL} = 0V, unless otherwise noted.

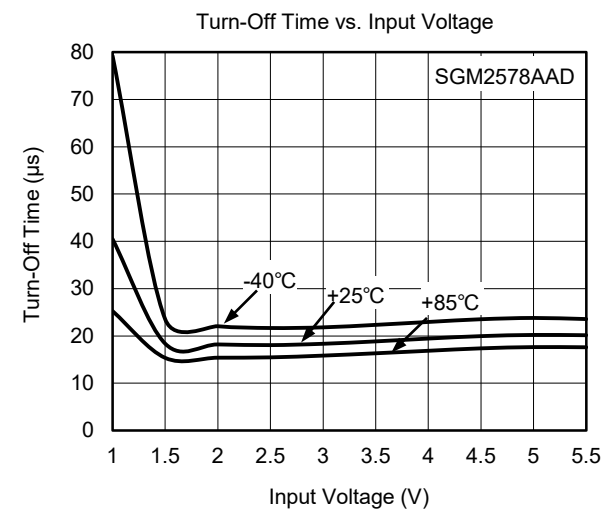
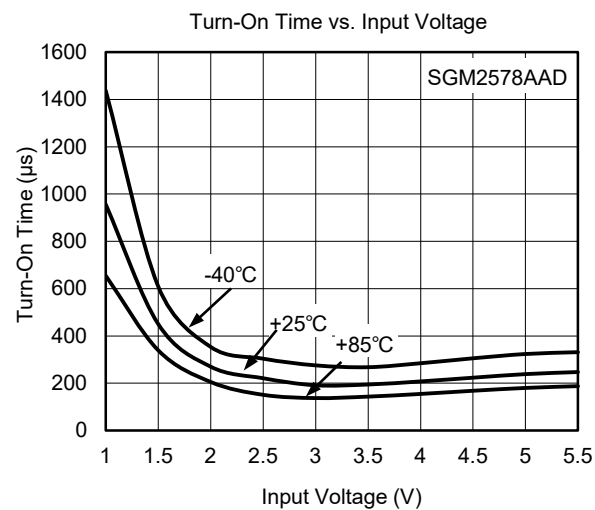
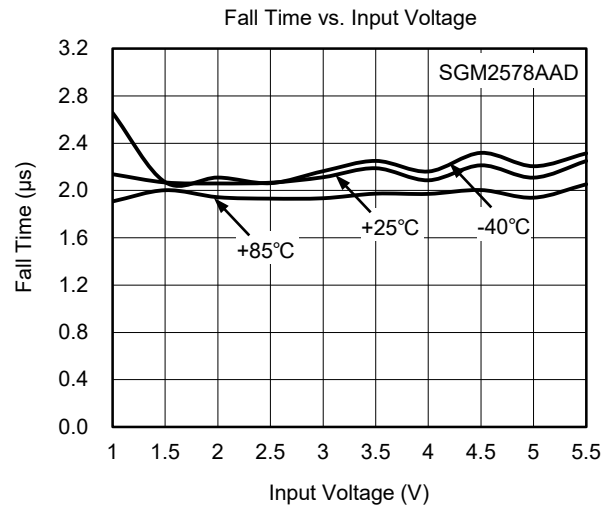
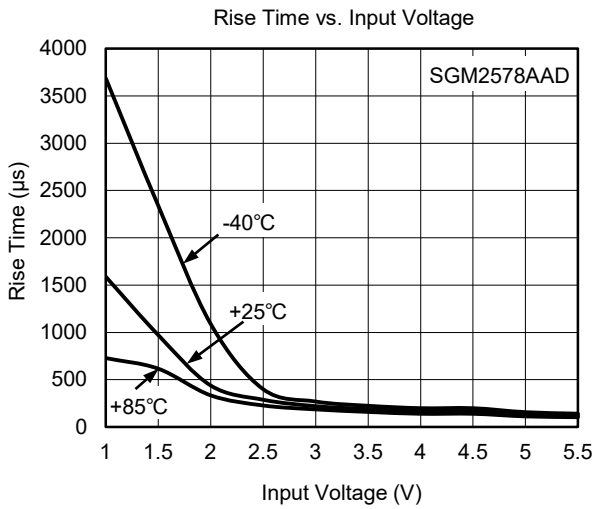
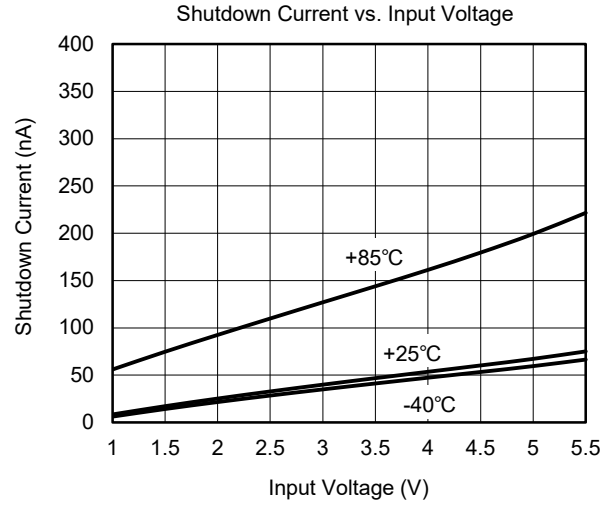
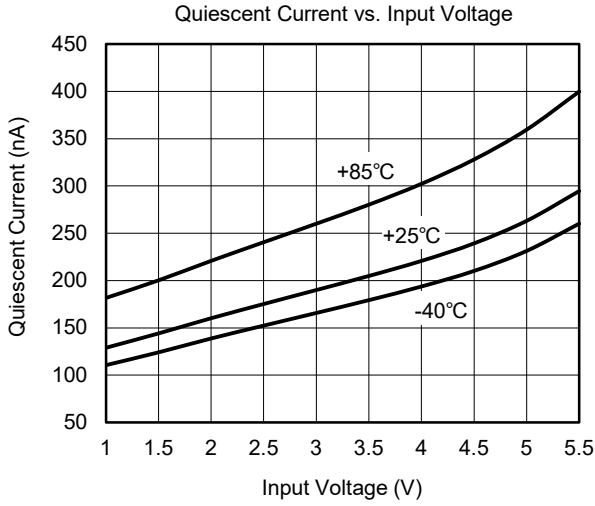

SGM2578A 5.5V, 2A, 30mΩ R_{ON}, Load Switch with Reverse Current Protection and Controlled Turn-On

TYPICAL PERFORMANCE CHARACTERISTICS (continued)

T_J = +25°C, C_{IN} = 1μF, C_{OUT} = 0.1μF, R_{OUT} = 10Ω, V_{IH} = 1.2V, V_{IL} = 0V, unless otherwise noted.

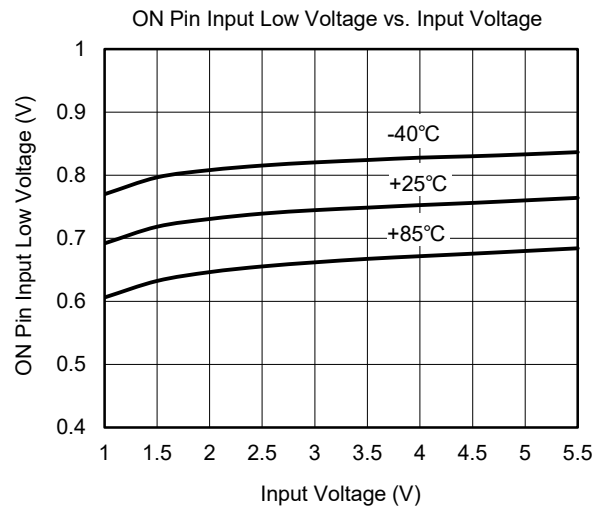
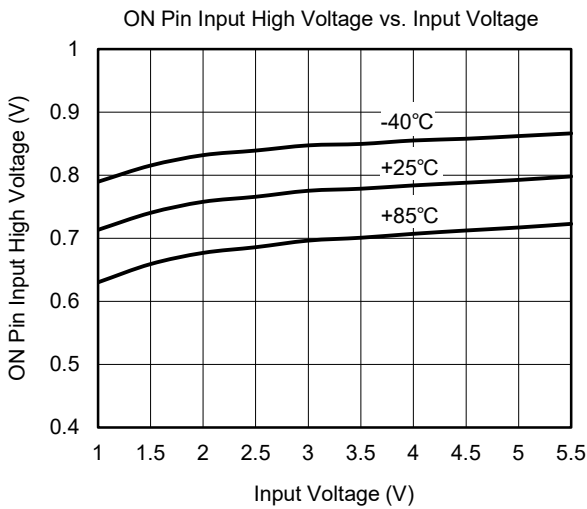
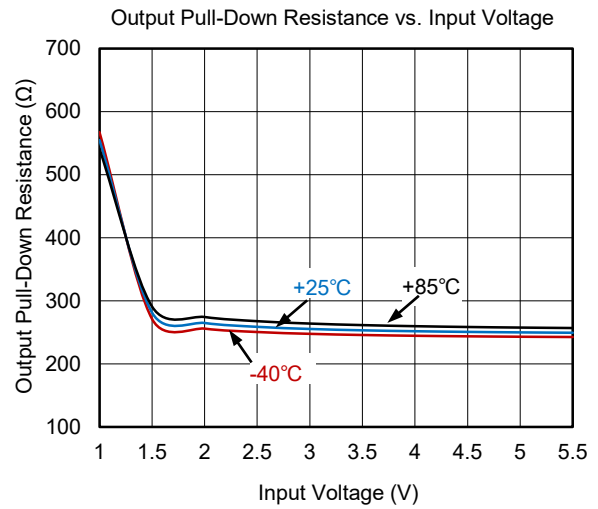
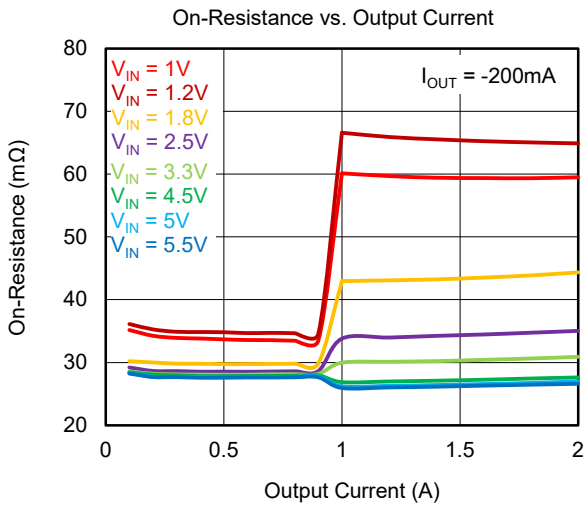
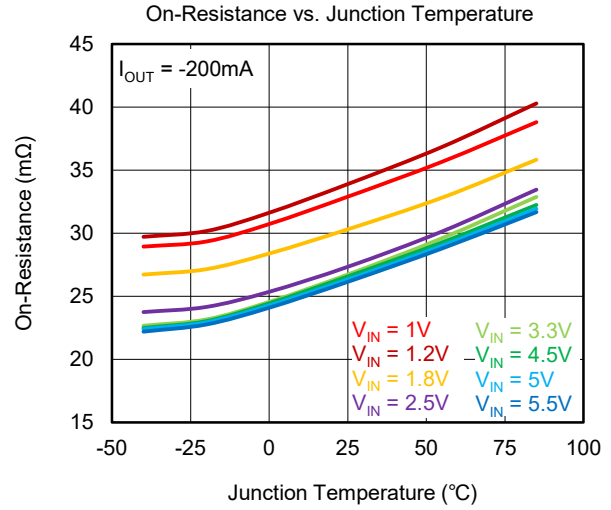
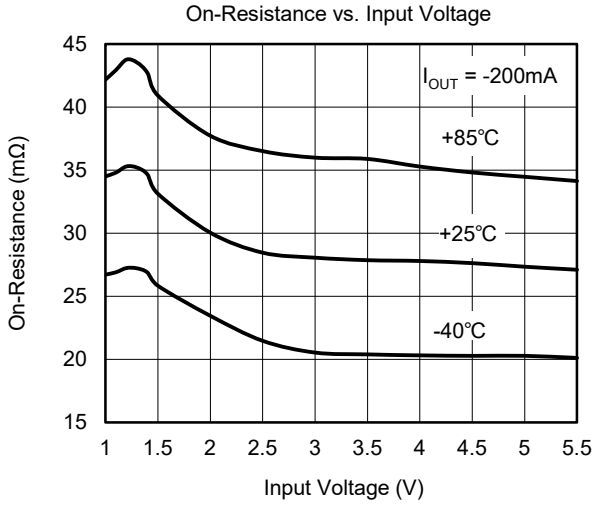

TYPICAL PERFORMANCE CHARACTERISTICS (continued)

T_J = +25°C, C_{IN} = 1μF, C_{OUT} = 0.1μF, R_{OUT} = 10Ω, V_{IH} = 1.2V, V_{IL} = 0V, unless otherwise noted.

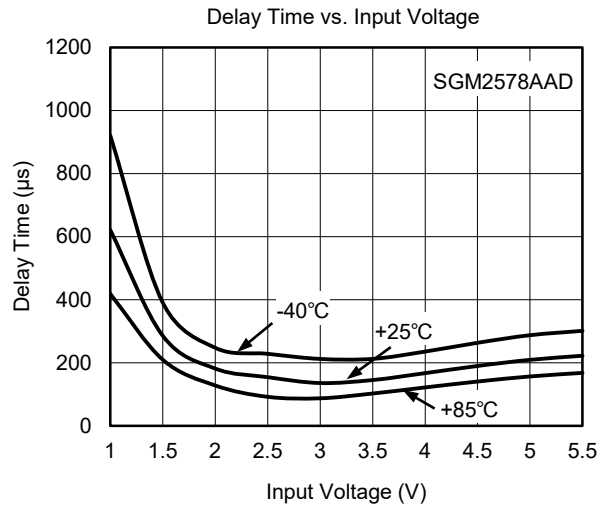
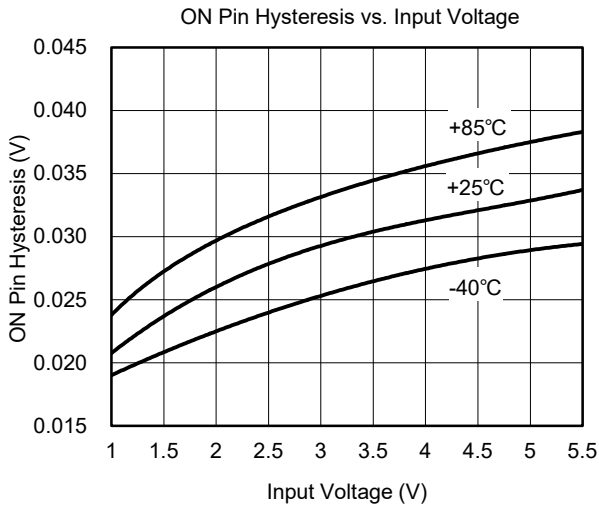

DETAILED DESCRIPTION

The SGM2578A is a small, 4 balls, 2A load switch. The device implements an N-MOSFET to provide an ultra-low on-resistance for a low voltage drop across the device. A controlled rise time is used in applications to limit the inrush current.

On/Off Control

The ON pin controls the state of the switch. It is an active "high" pin and has the capability to interface with low voltage GPIO. It can be used with any microcontroller with 1.8V, 2.5V, 3.3V or 5.5V GPIOs. Applying V_{IH} on the ON pin will put the switch in the on-state and V_{IL} will put the switch in the off-state.

Quick Output Discharge

The SGM2578A integrates the quick output discharge (QOD) feature. When the switch is disabled (below V_{IL}), a 280Ω (TYP) discharge resistance is connected between the output and ground. This resistance pulls

down the output and prevents it from floating when the device is disabled.

Device Functional Modes

Table 1 describes the connection of the VOUT pin depending on the state of the ON pin.

Table 1. VOUT Connection

ON Pin	VOUT Pin
L	GND
H	VIN

Table 2. Smart-ON Functional Modes

ON	ON Pin
Below V _{IL}	Pull-Down Active
Above V _{IH}	No Pull-Down

APPLICATION INFORMATION

SGM2578A is a single channel, up to 2A load switch with ultra-low on-resistance, which can be directly connected to the 1S battery in portable consumer devices such as smartphones, NB-IoT, etc. The wide input voltage range (from 1V to 5.5V) makes it suitable to be used for lower voltage rails as well inside different end equipment to accomplish power sequencing, inrush current control and reducing leakage current in sub-systems that are in standby mode. Figure 4 shows the typical application circuit of SGM2578A.

Input Capacitor

To limit the voltage drop on the input supply caused by transient inrush currents when the switch turns on into a discharged load capacitor, a capacitor needs to be placed between VIN and GND pins. A 1μF ceramic capacitor (C_{IN}) must be placed close to the VIN pin. A higher value of C_{IN} can be used to further reduce the voltage drop experienced as the switch is turned on into a large capacitive load.

Output Capacitor

A 0.1μF output capacitor (C_{OUT}) should be placed between VOUT and GND pins. This capacitor will prevent parasitic board inductances from forcing V_{OUT} to be negative when the switch turns off. It is generally recommended to have C_{IN} greater than C_{OUT} so that once the switch is turned on, C_{OUT} can charge up to V_{IN} without V_{IN} dropping significantly. A 0.1μF ceramic capacitor that is placed close to the IC pins is usually sufficient.

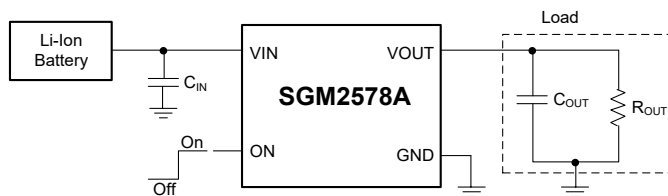

Figure 4. Typical Application Circuit

SGM2578A 5.5V, 2A, 30mΩ R_{ON}, Load Switch with Reverse Current Protection and Controlled Turn-On

APPLICATION INFORMATION (continued)

Reverse Current Protection

The SGM2578A includes a reverse current protection circuit, which stops a reverse current flowing from the V_{OUT} pin to the V_{IN} or GND pin when the voltage on V_{OUT} becomes higher than V_{IN}. This feature is particularly useful when the output of SGM2578A needs to be driven by another voltage source after SGM2578A is disabled (for example in a power multiplexer application). In order for this feature to work, SGM2578A has to be disabled and either V_{IN} > 1V or V_{OUT} > 1V should be met.

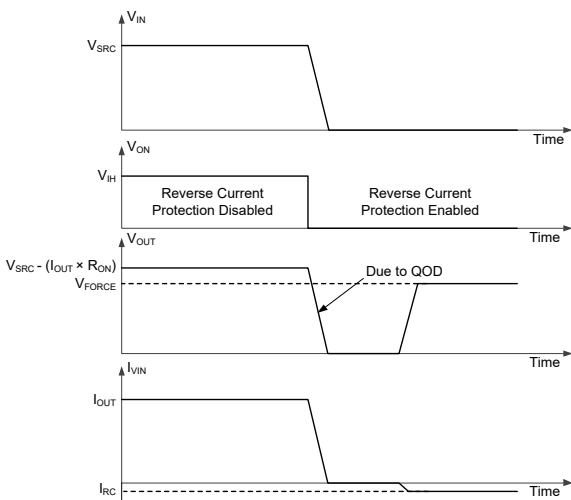

Figure 5. Reverse Current Protection

- I_{VIN} = current through VIN pin.
- V_{SRC} = input voltage applied to the device.
- V_{FORCE} = external voltage source forced at V_{OUT} pin of the device.
- I_{OUT} = output load current.

Figure 5 demonstrates the ideal behavior of reverse current protection circuit in SGM2578A. After the device is disabled by pulling the ON pin to low level and V_{OUT} pin is forced to an external voltage V_{FORCE}, a very small amount of current given by I_{RC}, V_{IN} will flow from V_{OUT} to V_{IN}. This will prevent any extra current loading on the voltage source supplying the V_{FORCE} voltage.

Power Supply Sequencing without a GPIO Input

In many terminal devices, each module needs to be powered up in a pre-determined manner. SGM2578A can solve the power sequencing problem without increasing any complexity to the overall system. Figure 6 shows the configuration required to power up the two modules in a fixed sequence. The output of the first load switch is tied to the enable of the second load switch, so when module 1 is powered, the second load switch is enabled and module 2 is powered.

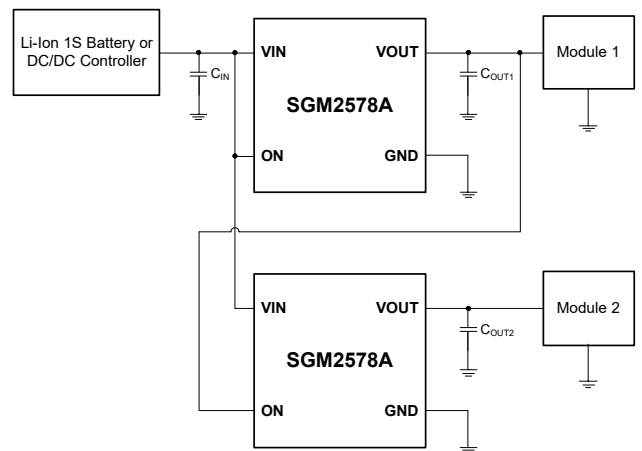

Figure 6. Power Supply Sequencing without a GPIO Input

Power Supply Recommendations

The device is designed to operate with a V_{IN} range of 1V to 5.5V. This supply must be well regulated and placed as close to the device terminal as possible with the recommended 1μF bypass capacitor. If the supply is located more than a few inches from the device terminals, an additional bulk capacitance may be required in addition to the ceramic bypass capacitors. If an additional bulk capacitance is required, the electrolytic, tantalum, or ceramic capacitor of 10μF may be sufficient.

REVISION HISTORY

NOTE: Page numbers for previous revisions may differ from page numbers in the current version.

Changes from Original (JUNE 2020) to REV.A	Page
Changed from product preview to production data.....	All

PACKAGE OUTLINE DIMENSIONS

WLCSP-0.9x0.9-4B-A

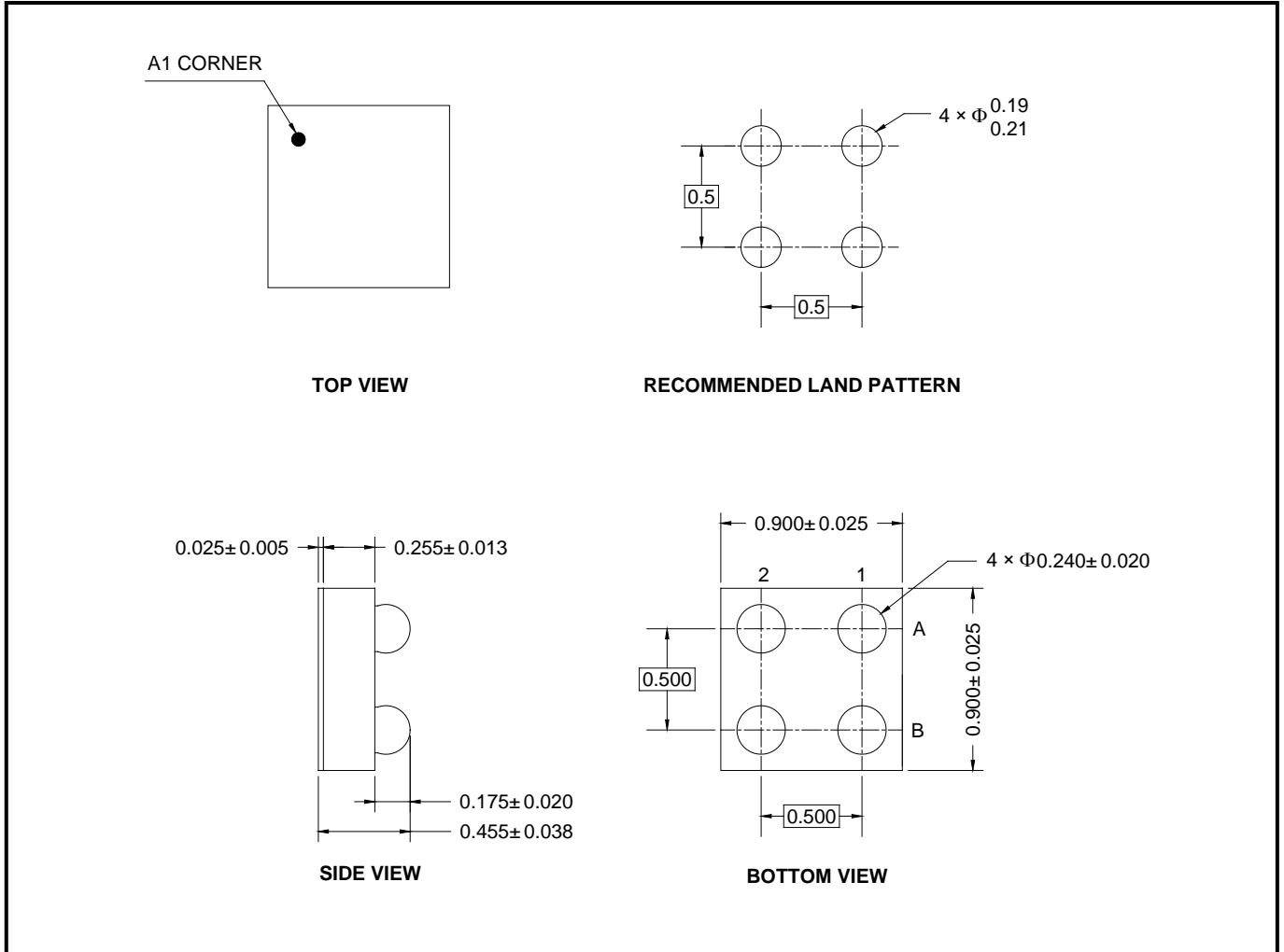

NOTE: All linear dimensions are in millimeters.

PACKAGE INFORMATION

TAPE AND REEL INFORMATION

REEL DIMENSIONS



TAPE DIMENSIONS



NOTE: The picture is only for reference. Please make the object as the standard.

KEY PARAMETER LIST OF TAPE AND REEL

Package Type	Reel Diameter	Reel Width W1 (mm)	A0 (mm)	B0 (mm)	K0 (mm)	P0 (mm)	P1 (mm)	P2 (mm)	W (mm)	Pin1 Quadrant
WLCSP-0.9×0.9-4B-A	7"	9.2	1.02	1.02	0.62	4.0	4.0	2.0	8.0	Q1

DD0001

PACKAGE INFORMATION

CARTON BOX DIMENSIONS



NOTE: The picture is only for reference. Please make the object as the standard.

KEY PARAMETER LIST OF CARTON BOX

Reel Type	Length (mm)	Width (mm)	Height (mm)	Pizza/Carton
7" (Option)	368	227	224	8
7"	442	410	224	18

DD0002