

GENERAL DESCRIPTION

The SGM2578 is an ultra small, low R_{ON} load switch with controlled turn on. The device contains an N-Channel MOSFET that operates over an input voltage range of 1V to 5V. The switch is controlled by EN pin, which is capable of interfacing directly with low voltage control signals.

SGM2578 device limits the output current to a safe level by using a constant current mode when the output load exceeds the current-limit threshold. An internal reverse voltage comparator disables the power switch when the output voltage is driven higher than the input to protect devices on the input side of the switch.

The SGM2578 is available in Green WLCSP-0.9×0.9-4B package and operates over a temperature range of -40°C to +85°C.

FEATURES

- **Low Input Voltage: 1V to 5V**
- **Ultra-Low On-State Resistance (R_{ON})**
 - $R_{ON} = 54m\Omega$ at $V_{IN} = 5.0V$
 - $R_{ON} = 54m\Omega$ at $V_{IN} = 3.6V$
 - $R_{ON} = 58m\Omega$ at $V_{IN} = 2.5V$
 - $R_{ON} = 74m\Omega$ at $V_{IN} = 1.8V$
 - $R_{ON} = 84m\Omega$ at $V_{IN} = 1.2V$
 - $R_{ON} = 84m\Omega$ at $V_{IN} = 1.0V$
- **1A Maximum Continuous Switch Current**
- **Quiescent Current: 5 μ A (TYP)**
- **Shutdown Current: < 1.5 μ A**
- **Low Control Input Thresholds Enable Use of Low-Voltage Logic**
- **Controlled Slew Rate to Avoid Inrush Currents**
- **Quick Output Discharge (QOD)**
- **Available in Green WLCSP-0.9×0.9-4B Package**

APPLICATIONS

- Battery Powered Equipment
- Portable Industrial Equipment
- Portable Medical Equipment
- Portable Media Players
- Point of Sales Terminal
- GPS Devices

TYPICAL APPLICATION

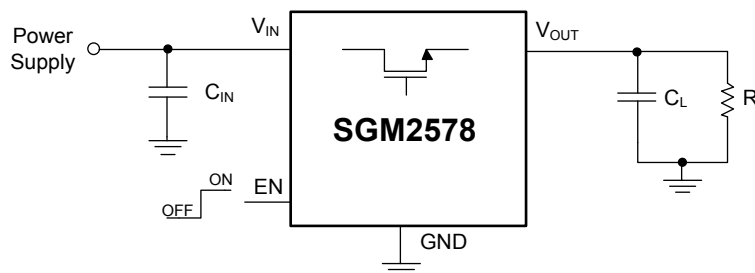

Figure 1. Typical Application Circuit

PACKAGE/ORDERING INFORMATION

MODEL	PACKAGE DESCRIPTION	SPECIFIED TEMPERATURE RANGE	ORDERING NUMBER	PACKAGE MARKING	PACKING OPTION
SGM2578	WLCSP-0.9×0.9-4B	-40°C to +85°C	SGM2578YG/TR	K2	Tape and Reel, 3000

Green (RoHS & HSF): SG Micro Corp defines "Green" to mean Pb-Free (RoHS compatible) and free of halogen substances. If you have additional comments or questions, please contact your SGMICRO representative directly.

ABSOLUTE MAXIMUM RATINGS

Input Voltage Range, V_{IN}	-0.3V to +5.5V
Output Voltage Range, V_{OUT}	-0.3V to ($V_{IN} + 0.3V$)
EN Voltage Range, V_{EN}	-0.3V to +5.5V
Maximum Continuous Switch Current, I_{MAX}	
$V_{IN} \geq 1.2V$	1000mA
$V_{IN} = 1.0V$	600mA
Package Thermal Resistance	
WLCSP-0.9×0.9-4B, θ_{JA}	188°C/W
Junction Temperature	+150°C
Storage Temperature Range	-65°C to +150°C
Lead Temperature (Soldering, 10s)	+260°C
ESD Susceptibility	
HBM	2000V
MM	300V

RECOMMENDED OPERATING CONDITIONS

Operating Temperature Range	-40°C to +85°C
Input Voltage Range, V_{IN}	1V to 5V
EN Voltage Range, V_{EN}	0V to 5V
Output Voltage Range, V_{OUT}	0V to V_{IN}

OVERSTRESS CAUTION

Stresses beyond those listed may cause permanent damage to the device. Functional operation of the device at these or any other conditions beyond those indicated in the operational section of the specification is not implied. Exposure to absolute maximum rating conditions for extended periods may affect reliability.

ESD SENSITIVITY CAUTION

This integrated circuit can be damaged by ESD if you don't pay attention to ESD protection. SGMICRO recommends that all integrated circuits be handled with appropriate precautions. Failure to observe proper handling and installation procedures can cause damage. ESD damage can range from subtle performance degradation to complete device failure. Precision integrated circuits may be more susceptible to damage because very small parametric changes could cause the device not to meet its published specifications.

DISCLAIMER

SG Micro Corp reserves the right to make any change in circuit design, specification or other related things if necessary without notice at any time.

PIN CONFIGURATION

(TOP VIEW)

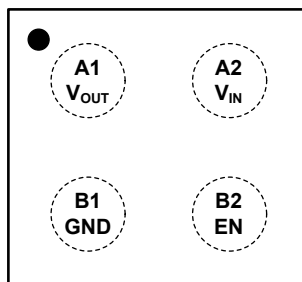

WLCSP-0.9×0.9-4B

PIN DESCRIPTION

PIN	NAME	FUNCTION
A1	V _{OUT}	Switch Output.
A2	V _{IN}	Switch Input and Power Supply. Bypass this input with an optional ceramic capacitor to ground. See Application Information.
B1	GND	Ground.
B2	EN	Switch Control Input. Active high. EN is internally pulled down and pull-down resistor is about 560k Ω .

FUNCTIONAL TABLE

EN	V _{IN} to V _{OUT}	V _{OUT} to GND
L	Off	On
H	On	Off

ELECTRICAL CHARACTERISTICS(Full = -40°C to +85°C, $V_{IN} = 3.6V$, unless otherwise noted.)

PARAMETER	SYMBOL	CONDITIONS	TEMP	MIN	TYP	MAX	UNITS
POWER SUPPLIES AND CURRENTS							
Quiescent Current	I_{IN}	$I_{OUT} = 0, V_{IN} = V_{EN}$	Full		5	12	μA
Off-State Supply Current	$I_{IN(OFF)}$	$V_{EN} = GND, V_{OUT} = Open$	Full		0.01	1.5	μA
Off-State Supply Current	$I_{IN(LEAK)}$	$V_{EN} = GND, V_{OUT} = 0V$	Full		0.01	1	μA
EN Pin Pull-Down Resistor	$R_{PULL-DOWN}$		+25°C	360	560	800	k Ω
RESISTANCE AND SWITCH CHARACTERISTICS							
On-State Resistance	R_{ON}	$I_{OUT} = 200mA$	$V_{IN} = 5.0V$	+25°C		54	m Ω
			$V_{IN} = 3.6V$	+25°C		54	
			$V_{IN} = 2.5V$	+25°C		58	
			$V_{IN} = 1.8V$	+25°C		74	
			$V_{IN} = 1.2V$	+25°C		84	
			$V_{IN} = 1.0V$	+25°C		84	
Output Pull-Down Resistance	R_{PD}	$V_{IN} = 3.3V, V_{EN} = GND, I_{OUT} = 30mA$	+25°C		50		Ω
EN							
Enable Input Logic High Voltage	V_{IH}	$V_{IN} = 1V \text{ to } 5V$	+25°C	1.6			V
Enable Input Logic Low Voltage	V_{IL}		+25°C	0		0.4	V
SWITCHING CHARACTERISTICS							
Turn-On Time	t_{ON}	$V_{IN} = 3.6V, R_L = 10\Omega, C_L = 0.1\mu F$	+25°C		680		μs
Turn-Off Time	t_{OFF}		+25°C		3.4		
V_{OUT} Rise Time	t_R		+25°C		590		
V_{OUT} Fall Time	t_F		+25°C		2.6		
Turn-On Time	t_{ON}	$V_{IN} = 1.0V, R_L = 10\Omega, C_L = 0.1\mu F$	+25°C		695		μs
Turn-Off Time	t_{OFF}		+25°C		34		
V_{OUT} Rise Time	t_R		+25°C		435		
V_{OUT} Fall Time	t_F		+25°C		14		

TYPICAL PERFORMANCE CHARACTERISTICS

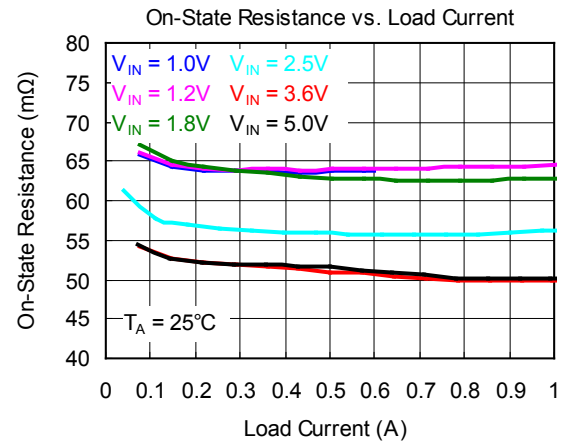
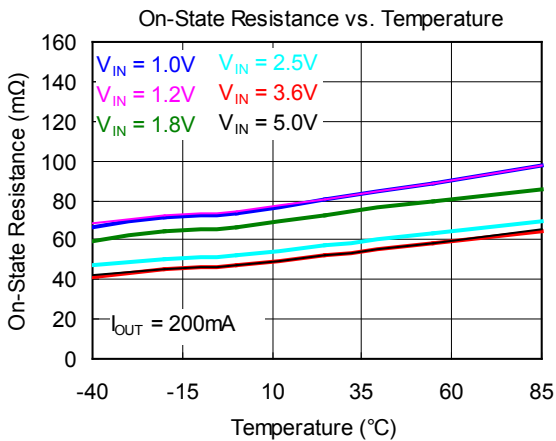
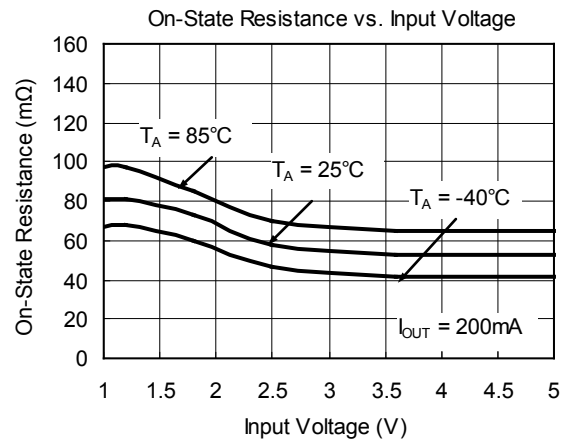
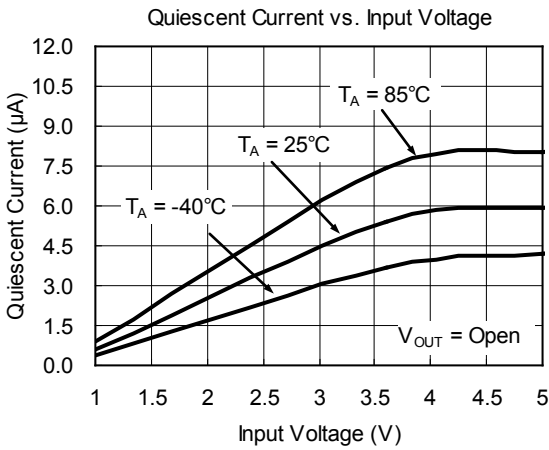
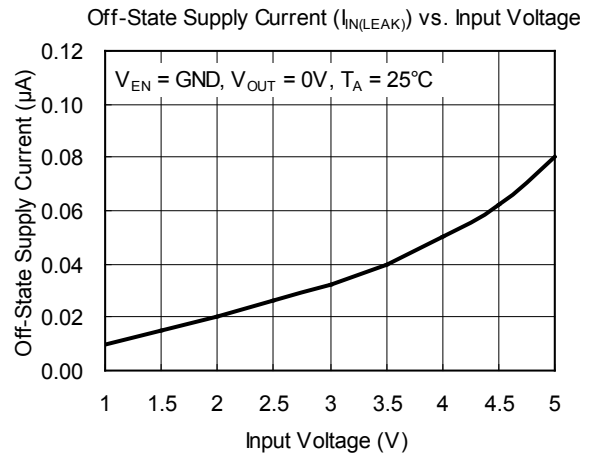
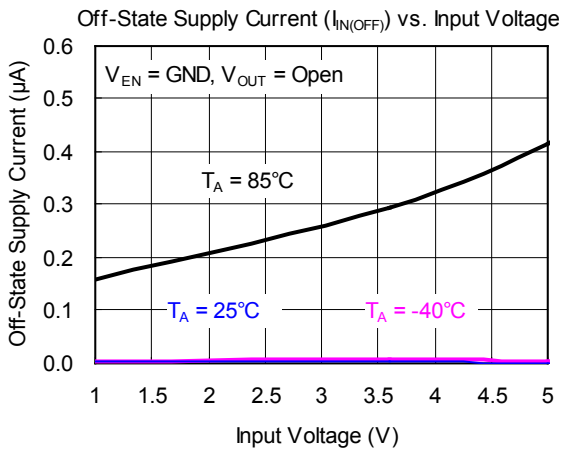

TYPICAL PERFORMANCE CHARACTERISTICS (continued)

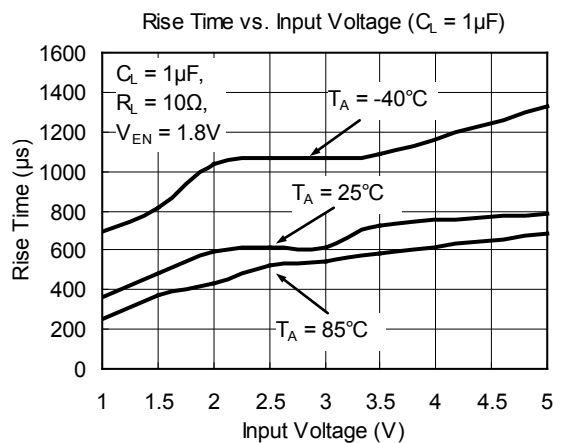
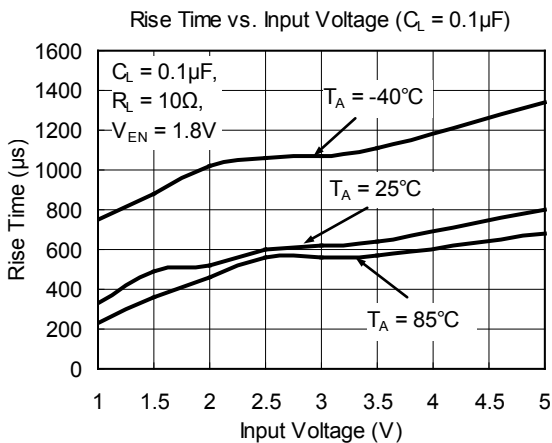
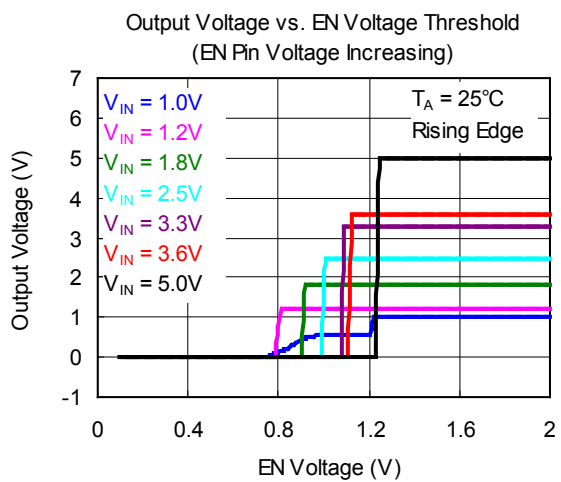
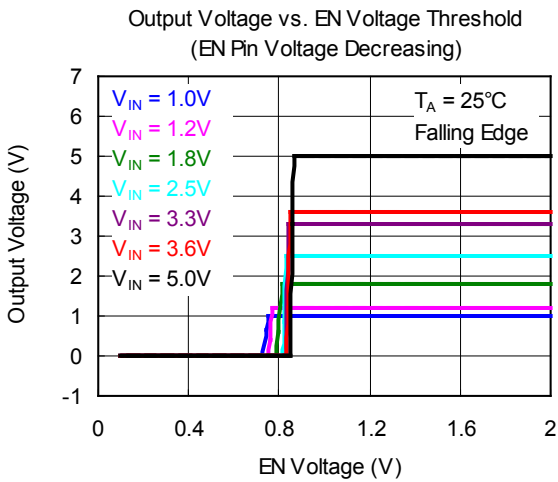
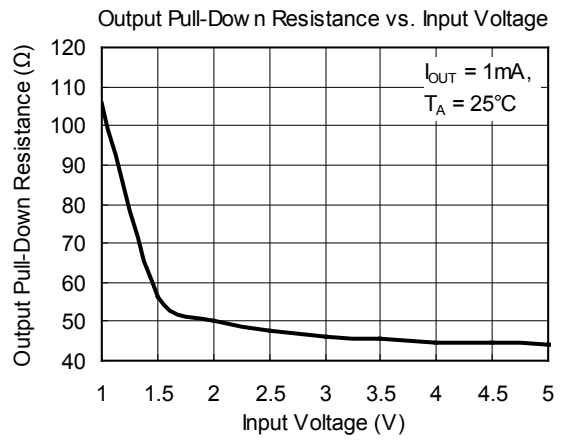
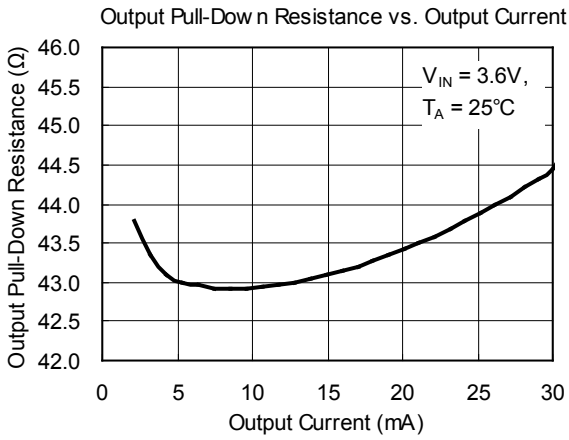

TYPICAL PERFORMANCE CHARACTERISTICS (continued)

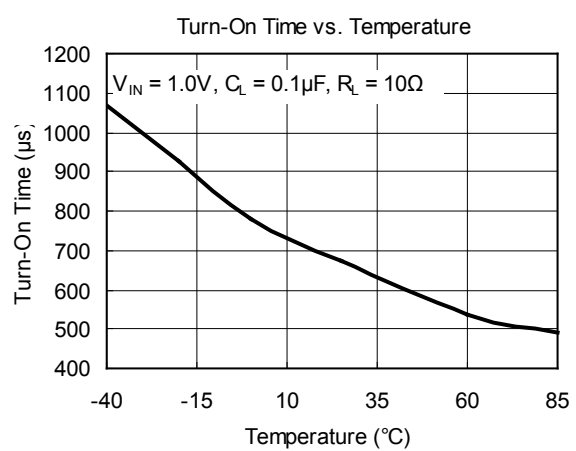
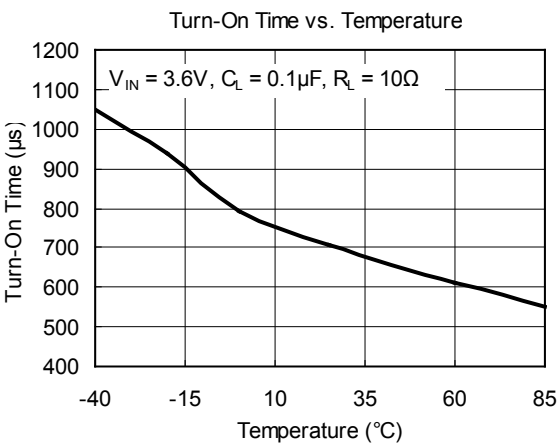
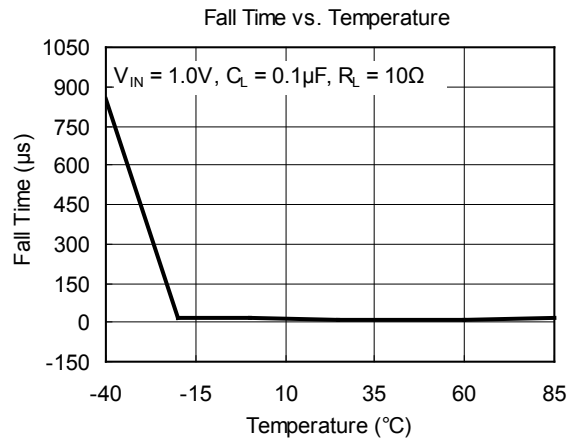
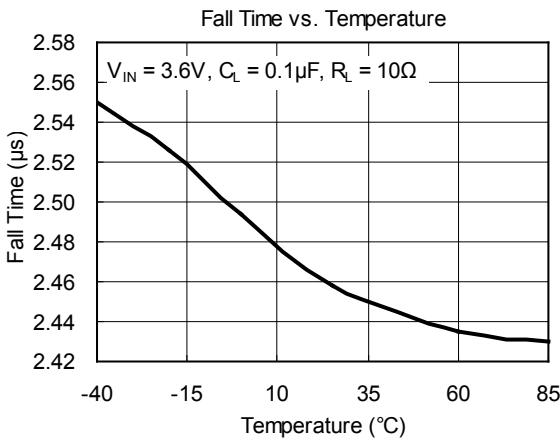
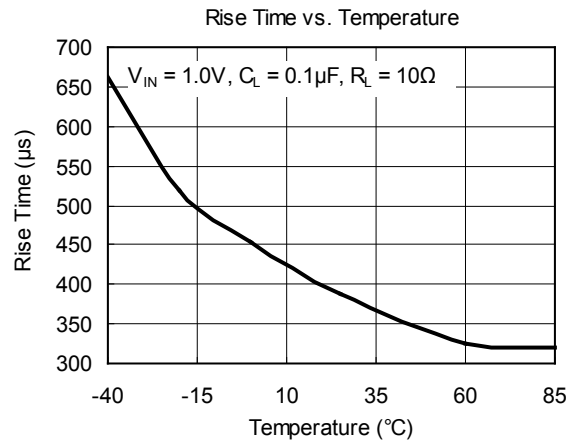
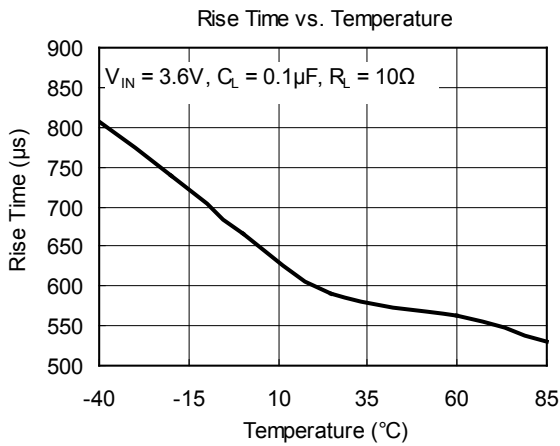

TYPICAL PERFORMANCE CHARACTERISTICS (continued)

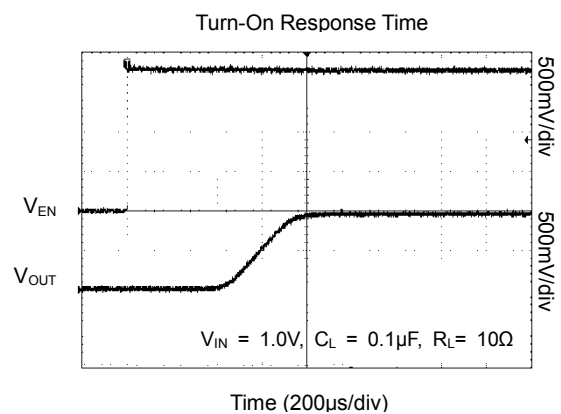
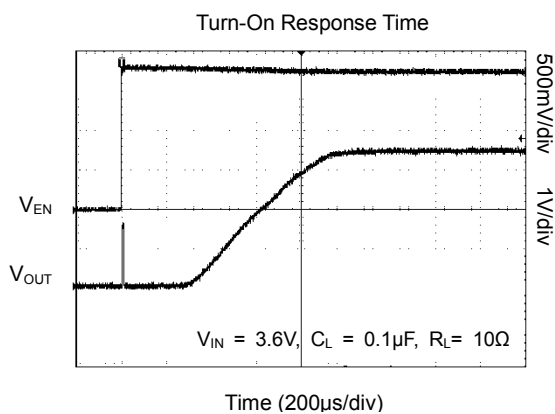
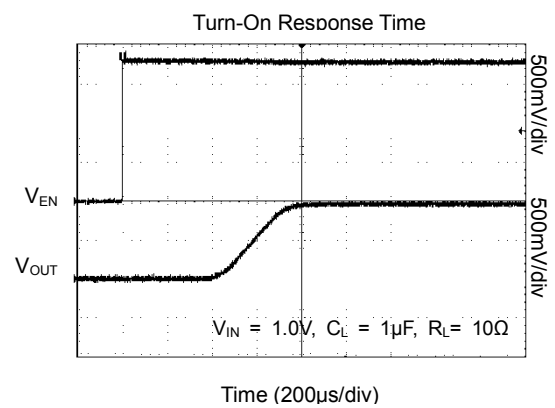
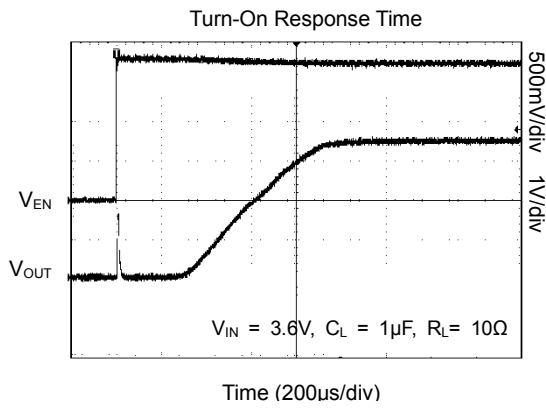
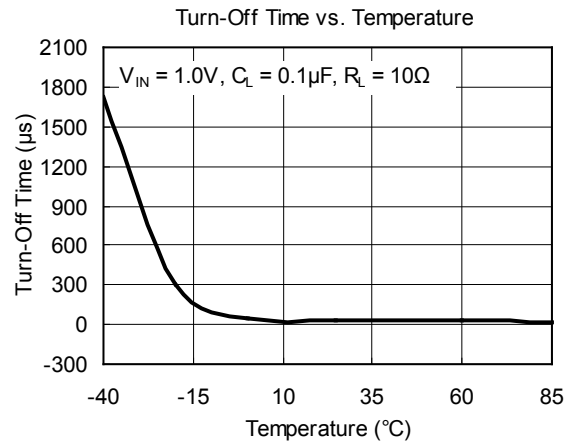
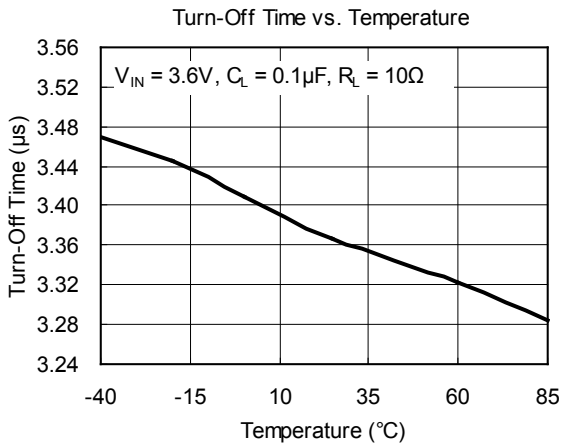

TYPICAL PERFORMANCE CHARACTERISTICS (continued)

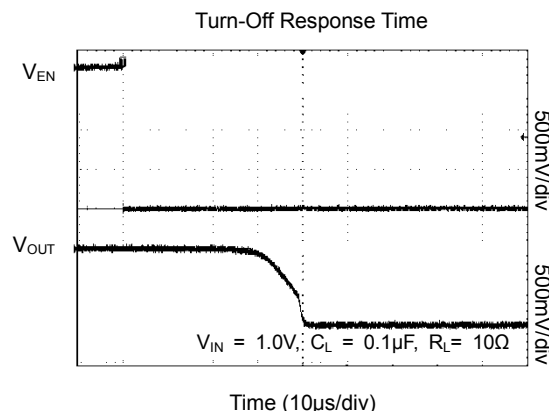
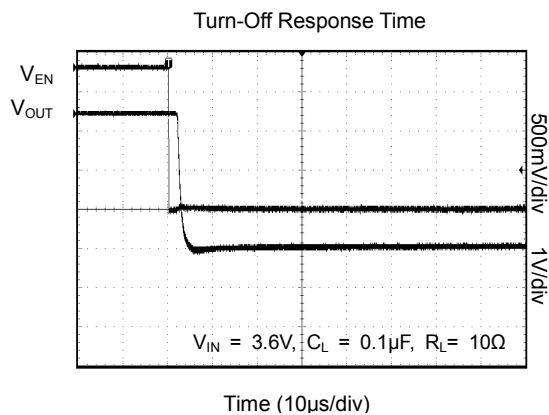
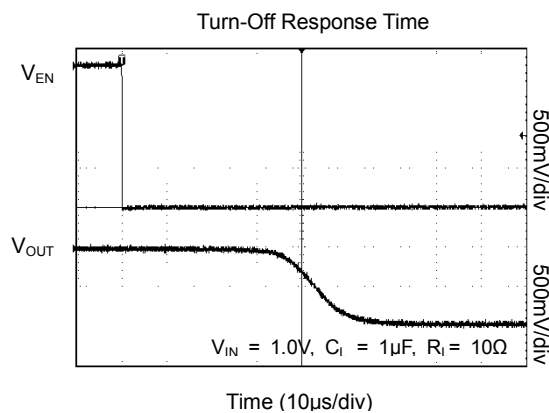
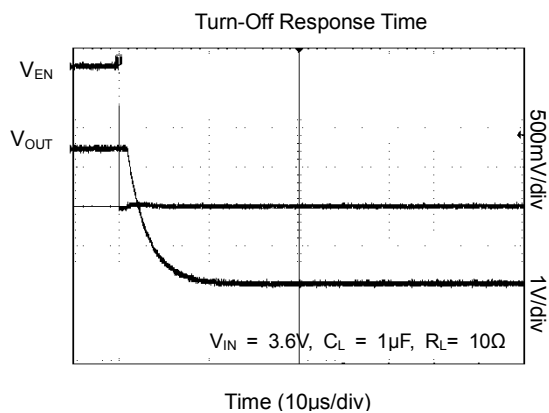

FUNCTIONAL BLOCK DIAGRAM

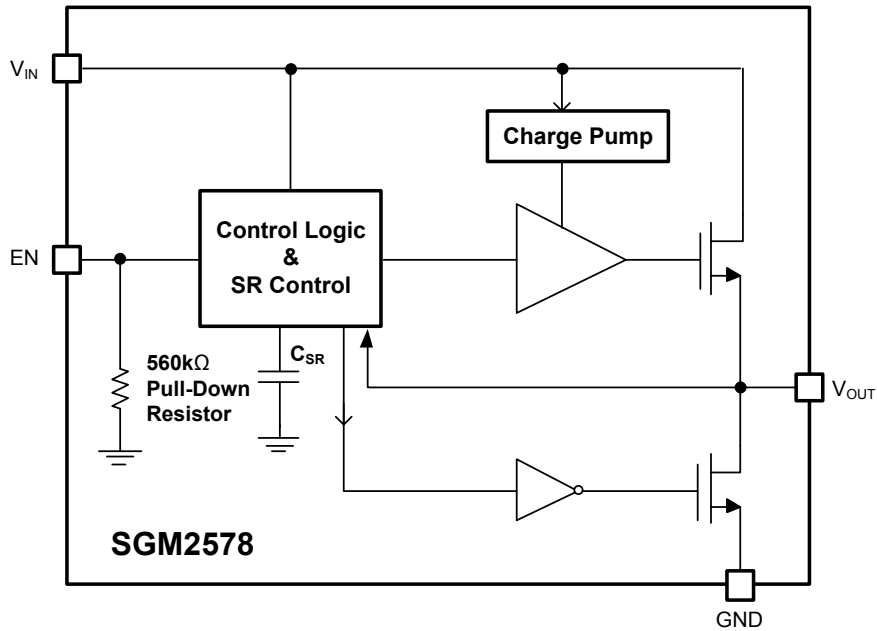
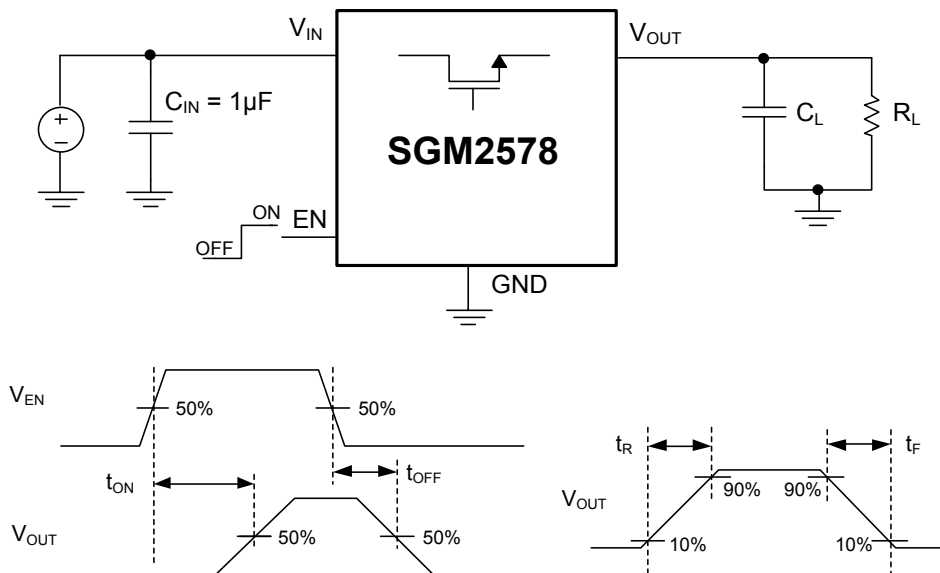

Figure 2. Block Diagram

PARAMETER MEASUREMENT INFORMATION



NOTE: Rise and fall times of the control signal are 100ns

Figure 3. Test Circuit and t_{ON}/t_{OFF} Waveforms

APPLICATION INFORMATION

Enable Control

The EN pin controls the state of the switch. Asserting EN high enables the switch. EN is active high and has a low threshold making it capable of interfacing with low-voltage control signals. The EN pin is compatible with standard GPIO logic threshold. It can be used with any microcontroller with 1.5V or higher GPIOs. Enable control pin has 560k Ω internal pull-down resistor.

Over-Current Condition

The SGM2578 responds to over-current condition by limiting output current to the $I_{LIMIT} = 1.6A$ (TYP). When an over-current condition is detected, the device maintains a constant output current and reduces the output voltage accordingly.

Reverse Voltage Protection

The reverse voltage protection turns off the N-Channel MOSFET whenever the output voltage exceeds the input voltage by 40mV (TYP) for 5ms (TYP). This prevents damage to devices on the input side of the SGM2578. The SGM2578 device allows the N-Channel MOSFET to turn on once the output voltage goes below the input voltage.

Thermal Sense

The SGM2578 has self-protection features using thermal sensing circuits that monitor the operating temperature of the power switch. The thermal sensor turns off the power switch when the die temperature exceeds 140°C (TYP). Hysteresis is built into the thermal sensor, and the switch turns on after the device has cooled down approximately 20°C.

Input and Output Capacitance

Input and output capacitance improves the performance of the device; the actual capacitance should be optimized for the particular application. For all applications, a 1 μ F or greater ceramic bypass capacitor between V_{IN} and GND is recommended as close to the device as possible. This precaution reduces ringing on the input due to power-supply transients. Additional input capacitance may be needed on the input to reduce voltage overshoot from exceeding the absolute maximum voltage of the device during heavy transient conditions. This is especially important during bench testing when long inductive cables are used to connect the evaluation board to the bench power-supply.

Placing a high-value electrolytic capacitor on the output pin is recommended when large transient currents are expected on the output.

Board Layout

For best performance, all traces should be as short as possible. To be most effective, the input and output capacitors should be placed close to the device to minimize the effects that parasitic trace inductances may have on normal operation. Using wide traces for V_{IN} , V_{OUT} , and GND helps minimize the parasitic electrical effects along with minimizing the case to ambient thermal impedance.

REVISION HISTORY

NOTE: Page numbers for previous revisions may differ from page numbers in the current version.

MAY 2017 – REV.A.1 to REV.A.2

Updated Packing Option.....	2
-----------------------------	---

JUNE 2014 – REV.A to REV.A.1

Changed the package.....	13
--------------------------	----

Changes from Original (MAY 2014) to REV.A

Changed from product preview to production data.....	All
--	-----

PACKAGE OUTLINE DIMENSIONS

WLCSP-0.9×0.9-4B

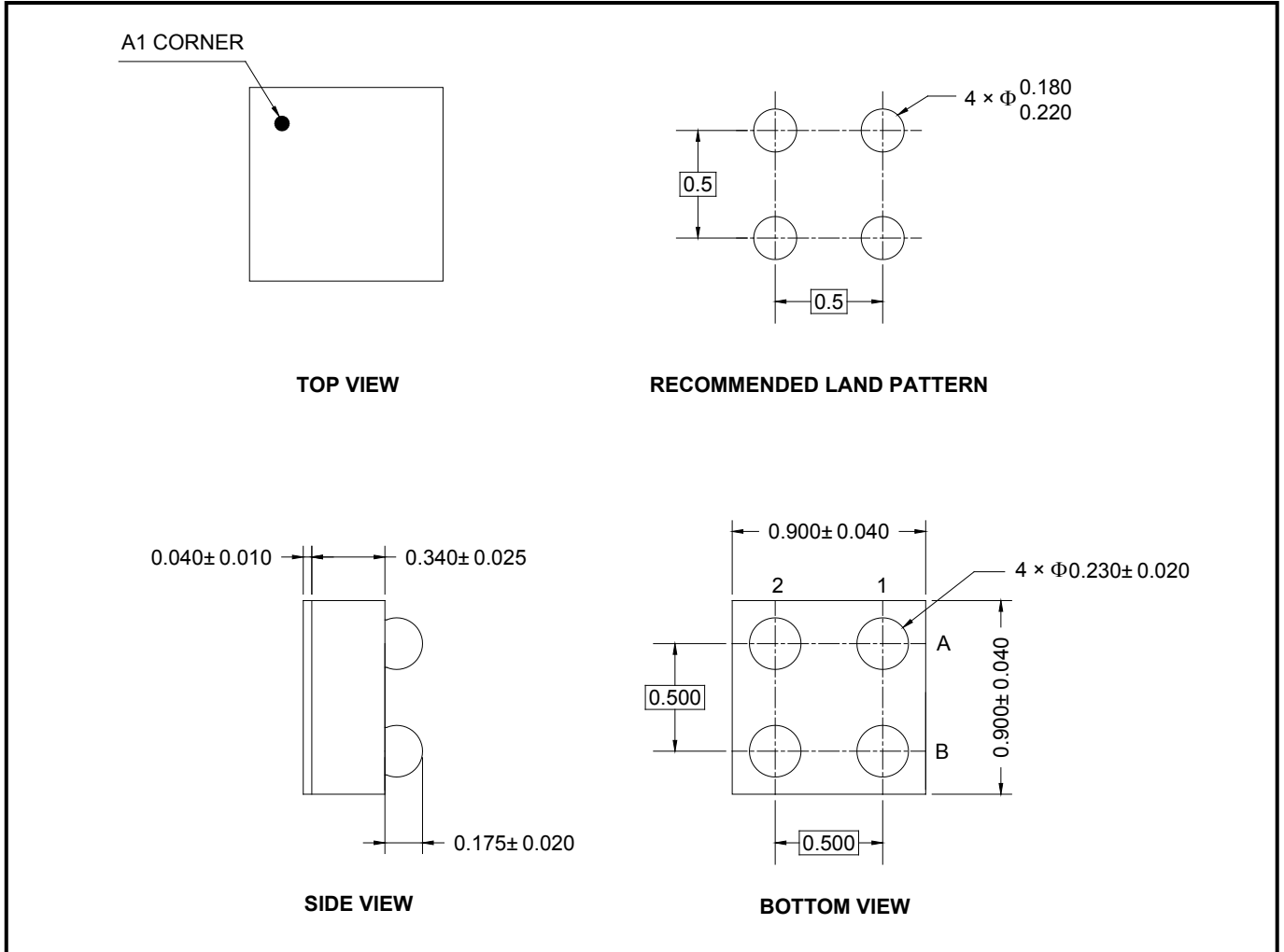

NOTE: All linear dimensions are in millimeters.

TAPE AND REEL INFORMATION

REEL DIMENSIONS

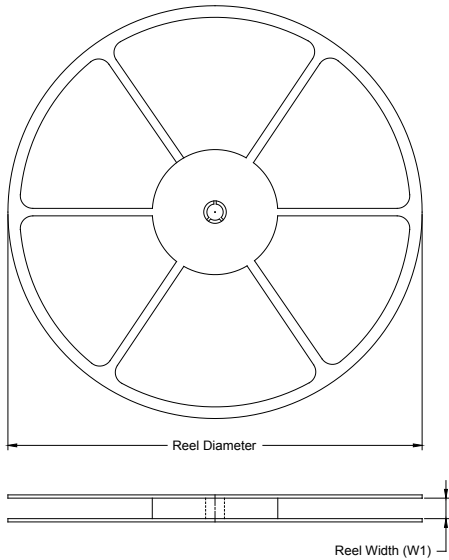

TAPE DIMENSIONS

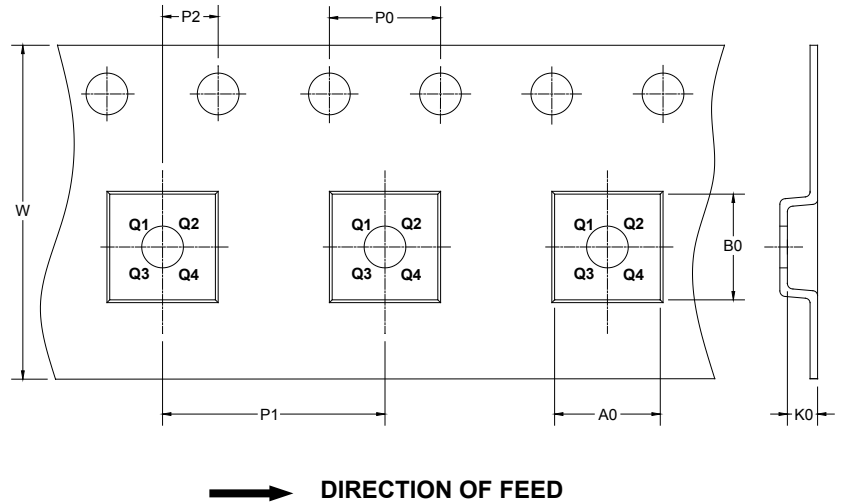

NOTE: The picture is only for reference. Please make the object as the standard.

KEY PARAMETER LIST OF TAPE AND REEL

Package Type	Reel Diameter	Reel Width W1 (mm)	A0 (mm)	B0 (mm)	K0 (mm)	P0 (mm)	P1 (mm)	P2 (mm)	W (mm)	Pin1 Quadrant
WLCSP-0.9×0.9-4B	7"	9.2	1.00	1.00	0.70	4.0	4.0	2.0	8.0	Q1

D00001

PACKAGE INFORMATION

CARTON BOX DIMENSIONS



NOTE: The picture is only for reference. Please make the object as the standard.

KEY PARAMETER LIST OF CARTON BOX

Reel Type	Length (mm)	Width (mm)	Height (mm)	Pizza/Carton
7" (Option)	368	227	224	8
7"	442	410	224	18

DD0002