

## CC/CV Mode Step-Down Converter

### DESCRIPTION

The EUP3462B is a step-down converter capable of driving 3A continuous load with excellent line and load regulation. The EUP3462B operates in either CC (Constant Current) mode or CV (Constant Voltage) mode with an input voltage range from 8V to 32V. The EUP3462B provides programmable cable compensation by adjusting external resistor divider. The EUP3462B stops switching when the output reaches over voltage threshold which is programmed by external resistor divider.

Fault protection includes secondary cycle-by-cycle current limit, short circuit protection and thermal shutdown. In shutdown mode the regulator draws 3 $\mu$ A of supply current. Internal soft-start minimizes the inrush supply current and the output overshoot at initial startup.

The EUP3462B is available in SOP-8 package.

### FEATURES

- 8V to 32V Wide Input Operating Range
- Fixed 120kHz Switching Frequency
- CC/CV Mode Control
- Up to 3A Output Current
- +/- 2.5% Voltage Reference Accuracy
- +/- 5.5% Constant Current Accuracy
- Programmable Cable Compensation
- Internal Soft Start
- Output Over Voltage Protection
- Foldback Short Circuit Protection
- Secondary Cycle-by-Cycle Current Limit
- Thermal Shutdown
- Available SOP-8 Package
- RoHS Compliant and 100% Lead(Pb)-Free Halogen-Free

### APPLICATIONS

- Car Charger
- Portable charger applications
- DC/DC converters with current limited

### Typical Application Circuit

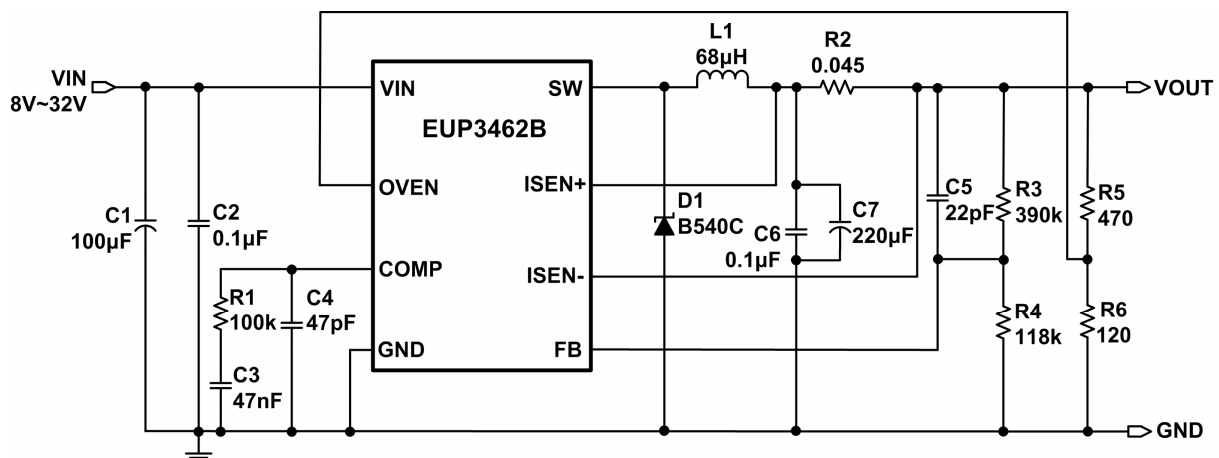

Figure 1. Application Circuit

**Pin Configurations**

Package Type	Pin Configurations
SOP-8	<p>(Top View)</p> <p>GND 1 8 COMP  FB 2 7 OVEN  ISEN- 3 6 VIN  ISEN+ 4 5 SW</p>

**Pin Description**

Pin Name	SOP-8	DESCRIPTION
GND	1	Ground.
FB	2	Output Feedback Input.
ISEN-	3	Current sense negative input pin.
ISEN+	4	Current sense positive input pin.
SW	5	Power Switcher Output.
VIN	6	Input Supply Pin.
OVEN	7	OV (output over voltage) threshold setting pin and enable Input. Drive OVEN voltage logic high to turn off the converter.
COMP	8	Loop compensation pin.

## Ordering Information

Order Number	Package Type	Marking	Quantity per Reel	Operating Temperature Range
EUP3462B DIR1	SOP-8	 XXXXX 3462B	2500	-40°C to +85°C

EUP3462B □ □ □ □

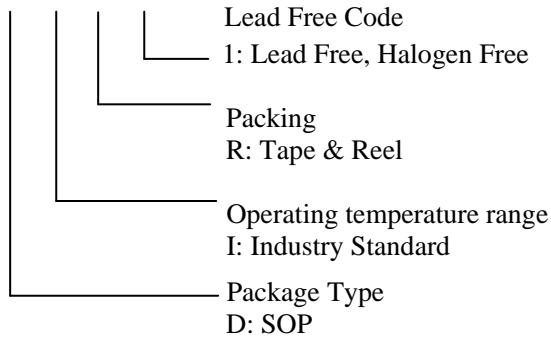

## Block Diagram

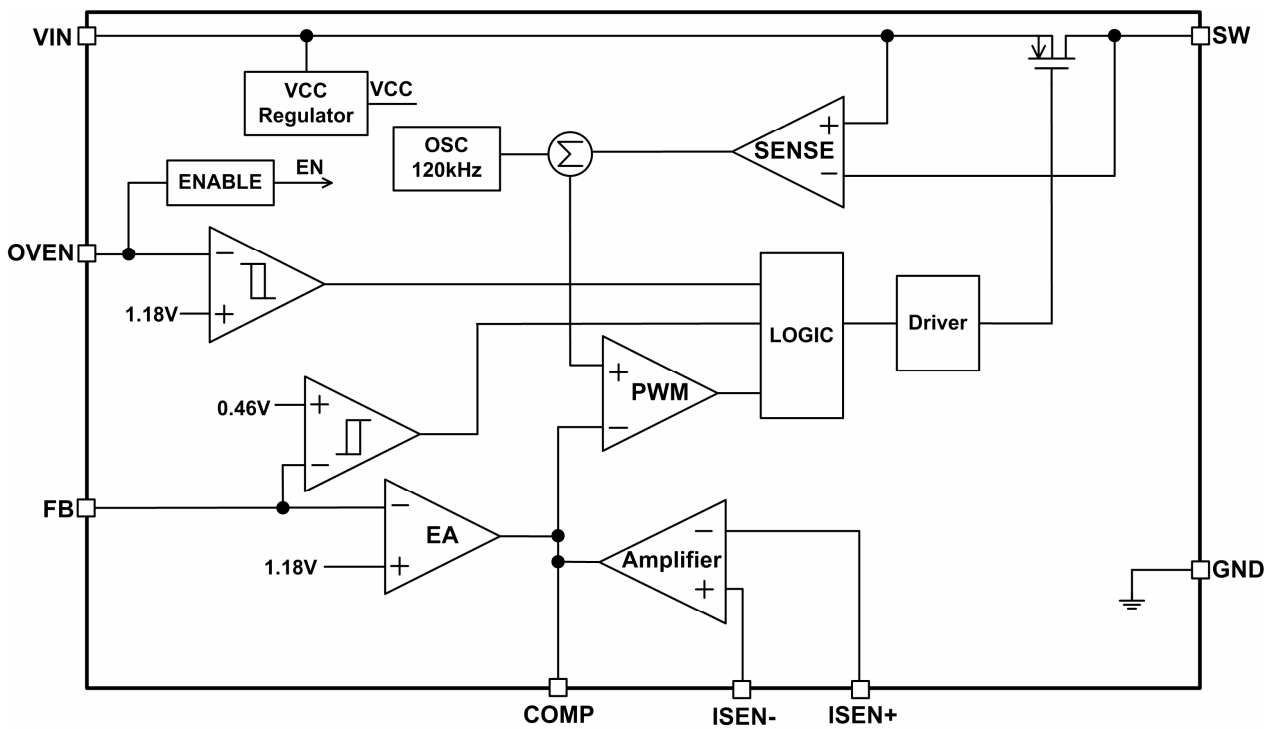

Figure 2. Functional Block Diagram

## Absolute Maximum Ratings (1)

■ Input Voltage ( $V_{IN}$ )	-----	-0.3V to 35V
■ Switch Voltage ( $V_{SW}$ )	-----	-1V to $V_{IN} + 0.3V$
■ ISEN+, ISEN-	-----	-0.3V to 9V
■ All Other Pins	-----	-0.3V to 6V
■ Junction Temperature	-----	150°C
■ Storage Temperature	-----	-65°C to +150°C
■ Lead Temp(Soldering, 10sec)	-----	260°C
■ Thermal Resistance $\theta_{JA}$ (SOP-8)	-----	125°C /W

## Recommend Operating Conditions (2)

■ Supply Voltage ( $V_{IN}$ )	-----	8V to 32V
■ Operating Temperature Range	-----	-40°C to +85°C

Note (1): Stress beyond those listed under “Absolute Maximum Ratings” may damage the device.

Note (2): The device is not guaranteed to function outside the recommended operating conditions.

## Electrical Characteristics

( $V_{IN}=12V$ ,  $T_A=+25^\circ C$ ,  $I_{OUT}=2.0A$ , unless otherwise specified)

Parameter	Conditions	EUP3462B			Unit
		Min.	Typ.	Max.	
Input voltage		8		32	V
Input No Load Current	$I_{OUT}=0A$			10	mA
Quiescent Current	$V_{OVEN}=0V, V_{FB}=1.5V$		0.5	1	mA
Shutdown Current	$V_{OVEN}=5V$		2.5		$\mu A$
Input Under Voltage Lockout Threshold Rising		6.2	6.7	7.2	V
Input Under Voltage Lockout Threshold Hysteresis			1		V
Current Limit			4.5		A
Operating frequency		100	120	140	kHz
Maximum Duty Cycle				100	%
Minimum On-Time			400		ns
Reference Voltage of the Voltage Error Amplifier		1.151	1.18	1.209	V
Reference Voltage of the Current Error Amplifier		111	118	125	mV
Transconductance of Error Amplifier			75		$\mu A / V$
Reference Voltage of the Over Voltage Comparator		1.145	1.18	1.215	V
Reference Voltage of the Short Circuit Foldback Comparator			0.46		V
OVEN Enable Threshold Voltage				0.4	V
OVEN Shutdown Threshold Voltage		2.5			V
Thermal Shut-down Temperature	Temperature Rising		150		$^\circ C$
	Temperature Falling		100		$^\circ C$
PMOS Drain-Source On-State Resistance	$V_{IN}=24V, I_{OUT}=1A$			95	$m\Omega$

## Typical Operating Characteristics

$V_{IN}=12V$ ,  $V_{OUT}=5V$ ,  $T_A=25^{\circ}C$ , unless otherwise noted.

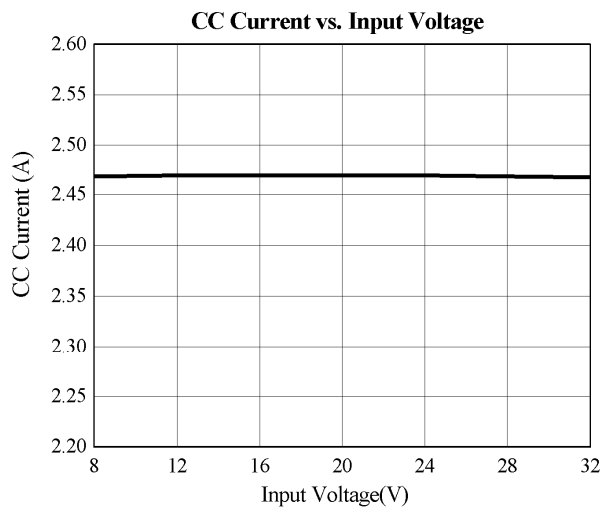
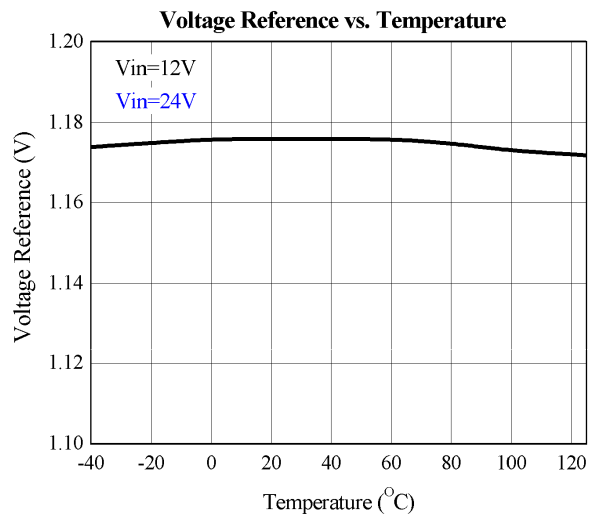
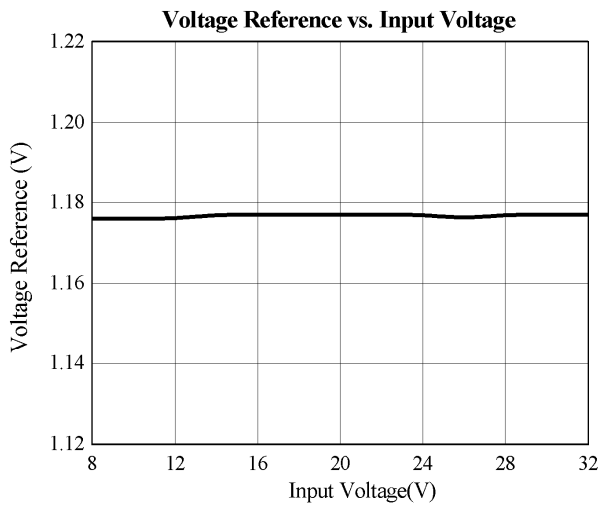
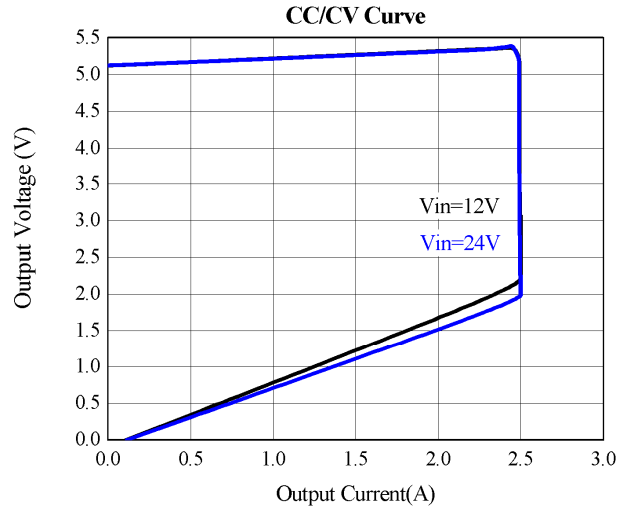
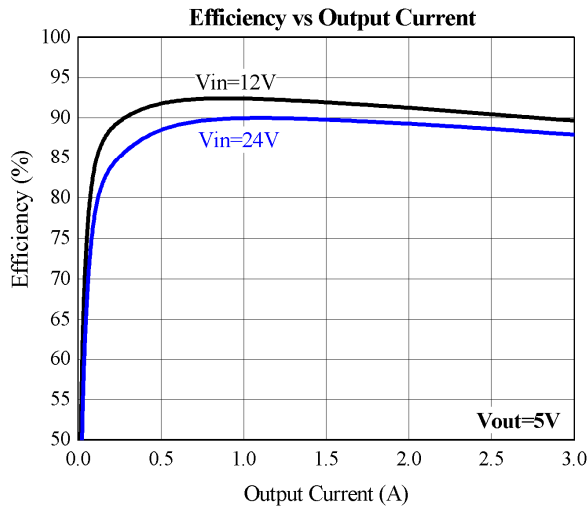

## Typical Operating Characteristics (continued)

$V_{IN}=12V$ ,  $V_{OUT}=5V$ ,  $T_A=25^{\circ}C$ , unless otherwise noted.

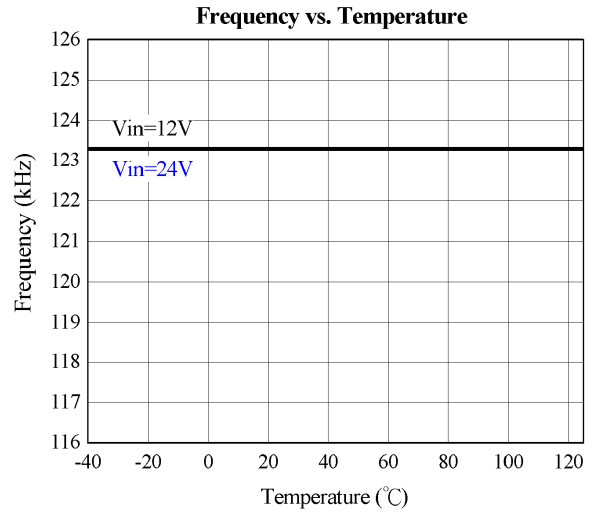
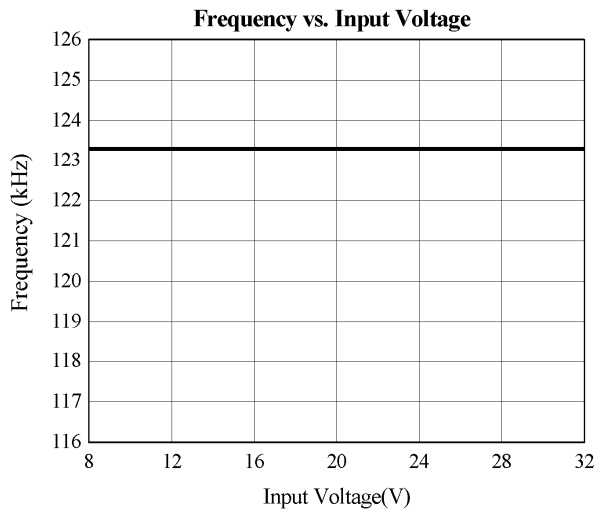

### Steady State

$V_{IN}=12V$ ,  $V_{OUT}=5V$ ,  $I_{OUT}=3A$

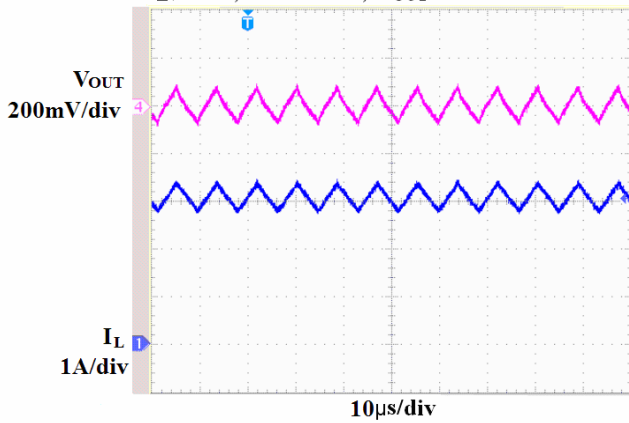

### Steady State

$V_{IN}=12V$ ,  $V_{OUT}=5V$ ,  $I_{OUT}=0A$

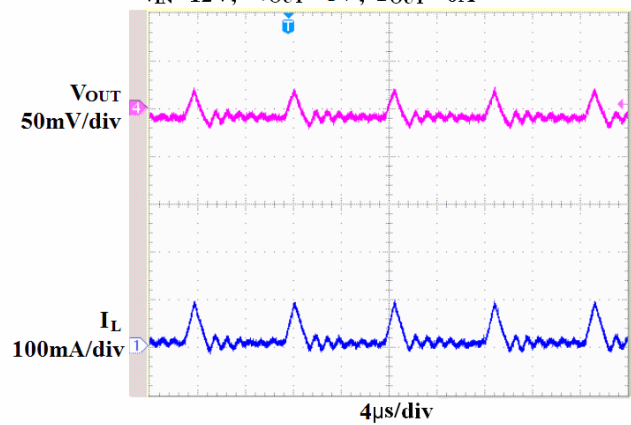

### Startup through Enable

$V_{IN}=12V$ ,  $V_{OUT}=5V$ , No Load

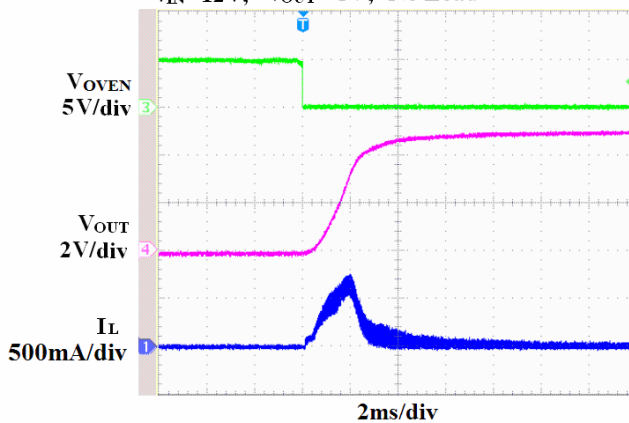

### Startup through Enable

$V_{IN}=12V$ ,  $V_{OUT}=5V$ ,  $I_{OUT}=3A$  (Resistance Load)

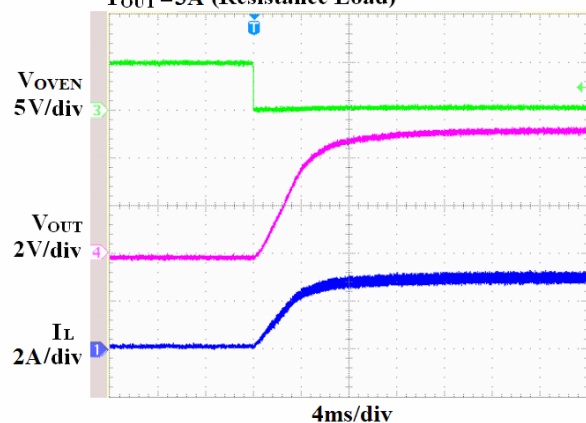

## Typical Operating Characteristics (continued)

$V_{IN}=12V$ ,  $V_{OUT}=5V$ ,  $T_A=25^\circ C$ , unless otherwise noted.

### Startup into CC mode

$V_{IN}=12V$ ,  $V_{OUT}=5V$ ,  
 $R_{LOAD}=1.6\Omega$ ,  $R_2=45m\Omega$

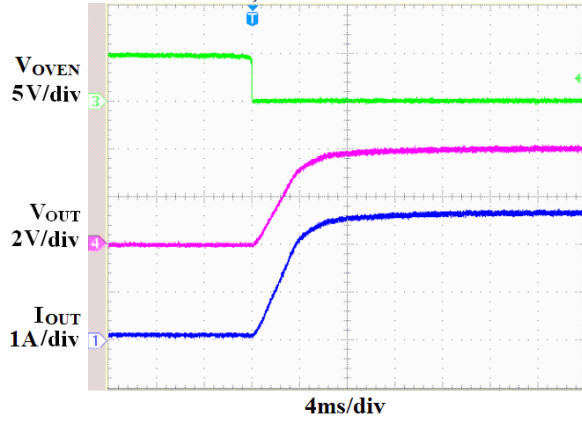

### Shutdown through Enable

$V_{IN}=12V$ ,  $V_{OUT}=5V$ ,  
 $I_{OUT}=3A$  (Resistance Load)

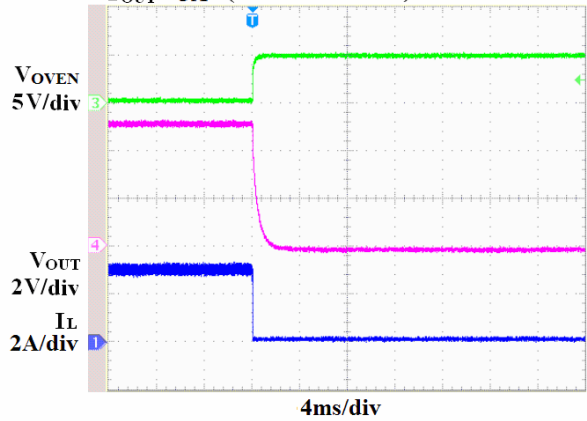

### CV mode to CC mode

$V_{IN}=12V$ ,  $V_{OUT}=5V$ ,  $R_2=45m\Omega$   
 $R_{LOAD}=2.5\Omega$  to  $1.6\Omega$

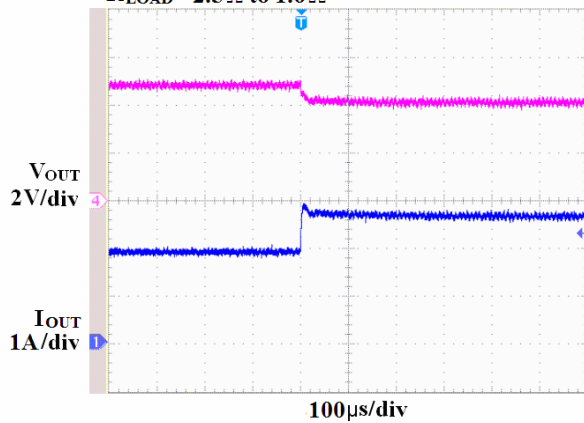

### CC mode to CV mode

$V_{IN}=12V$ ,  $V_{OUT}=5V$ ,  $R_2=45m\Omega$   
 $R_{LOAD}=1.6\Omega$  to  $2.5\Omega$

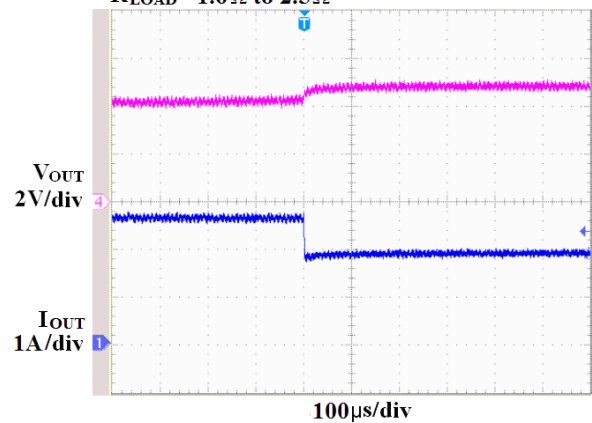

### Short Circuit

$V_{IN}=12V$ ,  $V_{OUT}=5V$ ,  $R_2=45m\Omega$

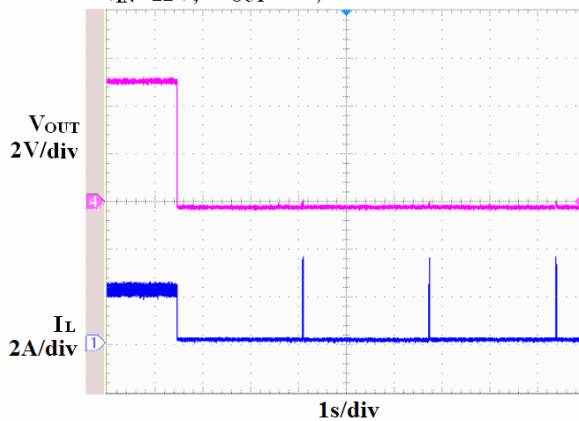

### Short Circuit Recovery

$V_{IN}=12V$ ,  $V_{OUT}=5V$ ,  $R_2=45m\Omega$

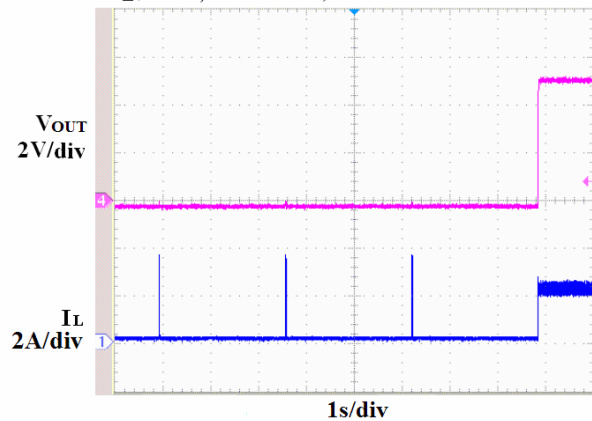

## Typical Operating Characteristics (continued)

$V_{IN}=12V$ ,  $V_{OUT}=5V$ ,  $T_A=25^{\circ}C$ , unless otherwise noted.

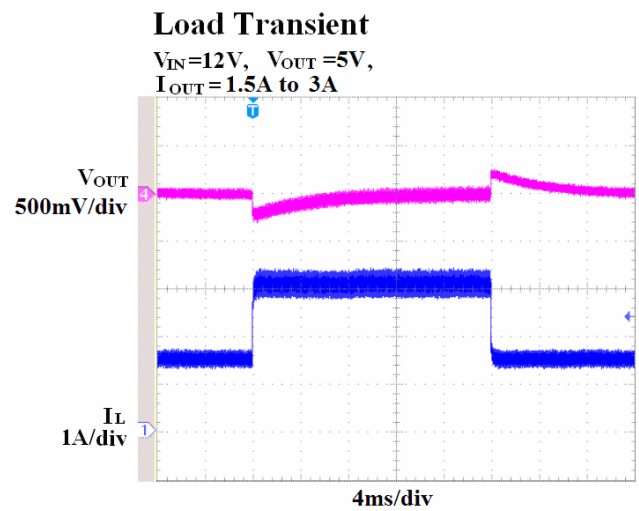
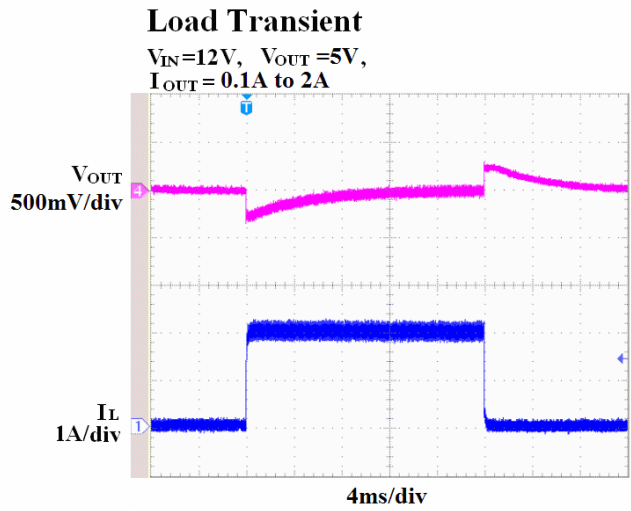



## Functional Description

The EUP3462B is a current-mode step-down converter with 8V to 32V input power supply. The device can provide up to 3A continuous current to the output. The EUP3462B uses current-mode architecture to control the regulator loop. The output voltage is measured at FB through a resistive voltage divider and amplified through the internal error amplifier. The output current of the transconductance error amplifier is presented at COMP pin where a RC network compensates the regulator loop. Slope compensation is internally added to eliminate subharmonic oscillation at high duty cycle. The slope compensation adds voltage ramp to the inductor current signal which reduces maximum inductor peak current at high duty cycles.

### CC/CV mode control

The EUP3462B operates in either CC mode or CV mode. The CV mode regulates the output voltage. When output current reaches the CC threshold, the device enters CC mode to limit the output current.

### Programmable cable compensation

The EUP3462B provides programmable cable compensation by adjusting the external resistor divider to compensate resistive voltage drop across the charger's output cable.

### Internal soft-start

Internal soft-start minimizes the inrush supply current and the output overshoot at initial startup.

### Over voltage protection

OVP (over voltage protection) function with programmable OV (over voltage) threshold set by the external resistor divider is provided. When output over voltage occurs, the device shuts down and returns to normal operation automatically when the output over voltage is released.

### Short circuit protection

The EUP3462B provides the output short circuit protection function to prevent large output short circuit from damaging the device. When output short happens, the device shuts down and returns to normal operation automatically when the short circuit condition is released.

### Thermal Shutdown

The EUP3462B stops switching when its junction temperature exceeds 150°C and resumes when the temperature has dropped by 50°C to protect the device.

## Application Information

The output voltage is set through a resistive voltage divider and can be expressed by the equation as follows

$$V_{OUT} = 1.18V * (R3 + R4) / R4$$

### Setting the CC current

EUP3462B constant current value is set by the resistor R2 connected between the ISEN- and ISEN+ pins. The CC current is determined by the equation as follows

$$I_{CC} = 0.118V / R2$$

### Setting the output over voltage threshold

The OVEN pin voltage is set by a resistor divider connected between VOUT and GND. When OVEN pin voltage is higher than 1.18V, the regulator stops switching until OVEN pin voltage falls below 1.18V. Thus the output over voltage threshold is

$$V_{OV} = 1.18V * (R5 + R6) / R6$$

### Setting the cable compensation

The EUP3462B provides programmable cable voltage drop compensation using the impedance at the FB pin to compensate voltage drop across the charger's output cable. The cable compensation voltage can be expressed as

$$\Delta V_{OUT} = 5.27\mu * I_{OUT} * R2 * R3$$

By adjust the value of R3, the cable compensation voltage can be programmed.

## Packaging Information

### SOP-8

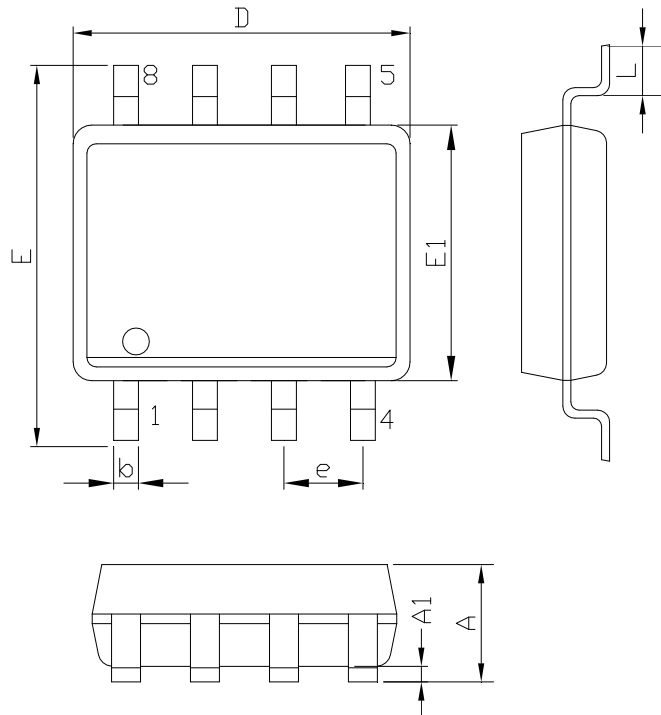

SYMBOLS	MILLIMETERS			INCHES		
	MIN.	Normal	MAX.	MIN.	Normal	MAX.
A	1.35	-	1.75	0.053	-	0.069
A1	0.05	-	0.25	0.002	-	0.010
D	4.80	4.90	5.00	0.189	0.193	0.197
E1	3.70	3.90	4.00	0.146	0.154	0.157
E	5.80	6.00	6.20	0.228	0.236	0.244
L	0.40	-	1.27	0.016	-	0.050
b	0.31	-	0.51	0.012	-	0.020
e	1.27 REF			0.050 REF		