

GENERAL DESCRIPTION

The SGM6032 is a 6MHz, step-down switching voltage regulator, with 600mA output current capability, that delivers a fixed output from an input voltage supply of 2.5V to 5.5V. Using an architecture with synchronous rectification, the SGM6032 is capable of delivering a peak efficiency of 90%, while maintaining efficiency over 80% at load currents as low as 1mA.

The regulator operates at a nominal fixed frequency of 6MHz, which reduces the value of the external components to as low as 470nH for the output inductor and 4.7μF for the output capacitor.

At moderate and light loads, pulse frequency modulation (PFM) is used to operate the device in power-save mode with a typical quiescent current of 22μA. Even with such a low quiescent current, the part exhibits excellent transient response during large load swings. At higher loads, the system automatically switches to fixed-frequency control, operating at 6MHz.

The SGM6032 is available in Green TDFN-2x2-6L and WLCSP-1.21x0.81-6B packages. It operates over an ambient temperature range of -40°C to +85°C.

FEATURES

- 600mA Output Current Capability
- 22μA Typical Quiescent Current
- 6MHz Fixed Frequency Operation
- Best-in-Class Load Transient Response
- Best-in-Class Efficiency
- 2.5V to 5.5V Input Voltage Range
- Output Voltages: 0.6V, 0.8V, 1.0V, 1.1V, 1.15V, 1.2V, 1.5V, 1.6V, 1.8V, 2.5V, 2.8V, 3.0V and 3.3V
- Low Ripple Light-Load PFM Mode
- Internal Soft-Start
- Input Under-Voltage Lockout (UVLO)
- Thermal Shutdown and Overload Protection
- Output Discharge
- Available in Green TDFN-2x2-6L and WLCSP-1.21x0.81-6B Packages
- -40°C to +85°C Operating Temperature Range

APPLICATIONS

3G, 4G, WiFi, WiMAX, and WiBro Data Cards
 Tablets
 DSC, DVC
 Netbooks, Ultra-Mobile PCs

TYPICAL APPLICATION

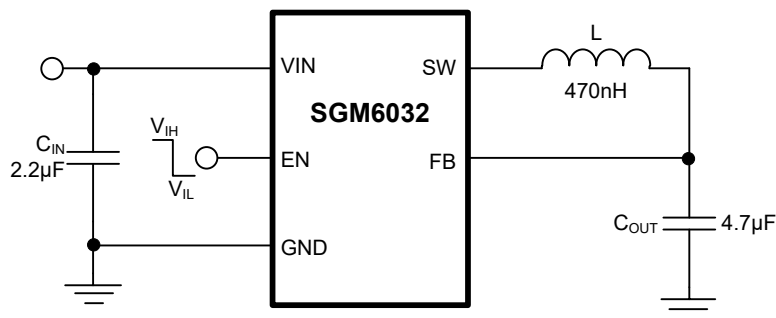

Figure 1. Typical Application Circuit

PACKAGE/ORDERING INFORMATION

MODEL	V _{OUT} (V)	PACKAGE DESCRIPTION	SPECIFIED TEMPERATURE RANGE	ORDERING NUMBER	PACKAGE MARKING	PACKING OPTION
SGM6032-0.6	0.6	TDFN-2×2-6L	-40°C to +85°C	SGM6032-0.6YTDI6G/TR	GKD XXXX	Tape and Reel, 3000
SGM6032-0.8	0.8	TDFN-2×2-6L	-40°C to +85°C	SGM6032-0.8YTDI6G/TR	MD2 XXXX	Tape and Reel, 3000
SGM6032-1.0	1.0	TDFN-2×2-6L	-40°C to +85°C	SGM6032-1.0YTDI6G/TR	MD4 XXXX	Tape and Reel, 3000
SGM6032-1.1	1.1	TDFN-2×2-6L	-40°C to +85°C	SGM6032-1.1YTDI6G/TR	GJ1 XXXX	Tape and Reel, 3000
SGM6032-1.15	1.15	TDFN-2×2-6L	-40°C to +85°C	SGM6032-1.15YTDI6G/TR	MD5 XXXX	Tape and Reel, 3000
SGM6032-1.2	1.2	TDFN-2×2-6L	-40°C to +85°C	SGM6032-1.2YTDI6G/TR	GL7 XXXX	Tape and Reel, 3000
SGM6032-1.5	1.5	TDFN-2×2-6L	-40°C to +85°C	SGM6032-1.5YTDI6G/TR	GKF XXXX	Tape and Reel, 3000
SGM6032-1.6	1.6	TDFN-2×2-6L	-40°C to +85°C	SGM6032-1.6YTDI6G/TR	M30 XXXX	Tape and Reel, 3000
SGM6032-1.8	1.8	TDFN-2×2-6L	-40°C to +85°C	SGM6032-1.8YTDI6G/TR	GJ5 XXXX	Tape and Reel, 3000
SGM6032-2.5	2.5	TDFN-2×2-6L	-40°C to +85°C	SGM6032-2.5YTDI6G/TR	GL2 XXXX	Tape and Reel, 3000
SGM6032-2.8	2.8	TDFN-2×2-6L	-40°C to +85°C	SGM6032-2.8YTDI6G/TR	GJ7 XXXX	Tape and Reel, 3000
SGM6032-3.0	3.0	TDFN-2×2-6L	-40°C to +85°C	SGM6032-3.0YTDI6G/TR	GL4 XXXX	Tape and Reel, 3000
SGM6032-3.3	3.3	TDFN-2×2-6L	-40°C to +85°C	SGM6032-3.3YTDI6G/TR	GL6 XXXX	Tape and Reel, 3000
SGM6032-0.6	0.6	WLCSP-1.21×0.81-6B	-40°C to +85°C	SGM6032-0.6YG/TR	KCXX	Tape and Reel, 3000
SGM6032-0.8	0.8	WLCSP-1.21×0.81-6B	-40°C to +85°C	SGM6032-0.8YG/TR	D3XX	Tape and Reel, 3000
SGM6032-1.0	1.0	WLCSP-1.21×0.81-6B	-40°C to +85°C	SGM6032-1.0YG/TR	W4XX	Tape and Reel, 3000
SGM6032-1.1	1.1	WLCSP-1.21×0.81-6B	-40°C to +85°C	SGM6032-1.1YG/TR	IFXX	Tape and Reel, 3000
SGM6032-1.15	1.15	WLCSP-1.21×0.81-6B	-40°C to +85°C	SGM6032-1.15YG/TR	W5XX	Tape and Reel, 3000
SGM6032-1.2	1.2	WLCSP-1.21×0.81-6B	-40°C to +85°C	SGM6032-1.2YG/TR	L0XX	Tape and Reel, 3000
SGM6032-1.5	1.5	WLCSP-1.21×0.81-6B	-40°C to +85°C	SGM6032-1.5YG/TR	KEXX	Tape and Reel, 3000
SGM6032-1.6	1.6	WLCSP-1.21×0.81-6B	-40°C to +85°C	SGM6032-1.6YG/TR	31XX	Tape and Reel, 3000
SGM6032-1.8	1.8	WLCSP-1.21×0.81-6B	-40°C to +85°C	SGM6032-1.8YG/TR	L8XX	Tape and Reel, 3000
SGM6032-2.5	2.5	WLCSP-1.21×0.81-6B	-40°C to +85°C	SGM6032-2.5YG/TR	L1XX	Tape and Reel, 3000
SGM6032-2.8	2.8	WLCSP-1.21×0.81-6B	-40°C to +85°C	SGM6032-2.8YG/TR	J6XX	Tape and Reel, 3000
SGM6032-3.0	3.0	WLCSP-1.21×0.81-6B	-40°C to +85°C	SGM6032-3.0YG/TR	L3XX	Tape and Reel, 3000
SGM6032-3.3	3.3	WLCSP-1.21×0.81-6B	-40°C to +85°C	SGM6032-3.3YG/TR	L5XX	Tape and Reel, 3000

MARKING INFORMATION

NOTE: XXXX = Date Code. XX = Date Code.

TDFN-2x2-6L

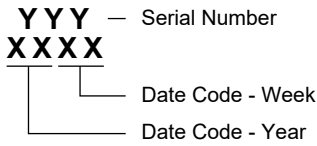

WLCSP-1.21x0.81-6B

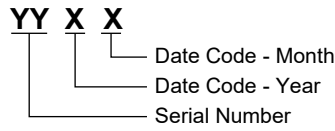

Green (RoHS & HSF): SG Micro Corp defines "Green" to mean Pb-Free (RoHS compatible) and free of halogen substances. If you have additional comments or questions, please contact your SGMICRO representative directly.

ABSOLUTE MAXIMUM RATINGS

Input Voltage.....	-0.3V to 6.5V
Voltage on SW and EN.....	-0.3V to $V_{IN} + 0.3V^{(1)}$
Package Thermal Resistance	
TDFN-2x2-6L, θ_{JA}	120°C/W
WLCSP-1.21x0.81-6B, θ_{JA}	150°C/W
Junction Temperature.....	+150°C
Storage Temperature Range.....	-65°C to +150°C
Lead Temperature (Soldering, 10s).....	+260°C
ESD Susceptibility	
HBM.....	4000V
MM.....	400V
CDM.....	1000V

NOTE: 1. Lesser of 6.5V or $V_{IN} + 0.3V$.

RECOMMENDED OPERATING CONDITIONS

Inductor, L.....	470nH
Input Capacitor, C_{IN}	2.2µF
Output Capacitor, C_{OUT}	4.7µF
Supply Voltage Range.....	2.5V to 5.5V
Operating Temperature Range.....	-40°C to +85°C

OVERSTRESS CAUTION

Stresses beyond those listed in Absolute Maximum Ratings may cause permanent damage to the device. Exposure to absolute maximum rating conditions for extended periods may affect reliability. Functional operation of the device at any conditions beyond those indicated in the Recommended Operating Conditions section is not implied.

ESD SENSITIVITY CAUTION

This integrated circuit can be damaged by ESD if you don't pay attention to ESD protection. SGMICRO recommends that all integrated circuits be handled with appropriate precautions. Failure to observe proper handling and installation procedures can cause damage. ESD damage can range from subtle performance degradation to complete device failure. Precision integrated circuits may be more susceptible to damage because very small parametric changes could cause the device not to meet its published specifications.

DISCLAIMER

SG Micro Corp reserves the right to make any change in circuit design, or specifications without prior notice.

PIN CONFIGURATIONS

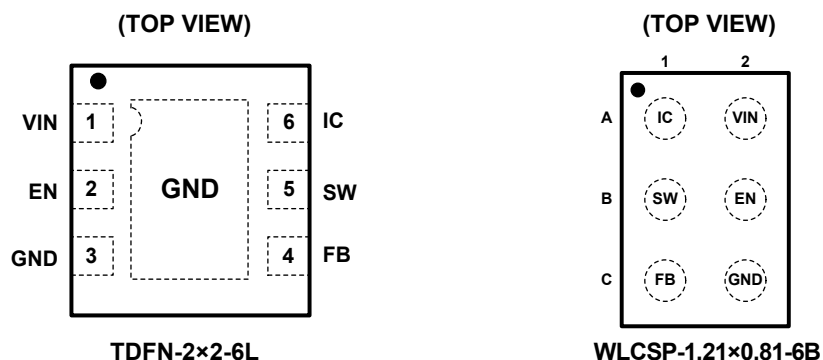

PIN DESCRIPTION

PIN		NAME	FUNCTION
TDFN-2×2-6L	WLCSP-1.21×0.81-6B		
1	A2	VIN	Input Voltage. Connect to input power source.
2	B2	EN	Forcing this Pin above 1.5V Enables the Part. Forcing this pin below 0.3V shuts down the device. In shutdown, all functions are disabled, drawing <math><1\mu\text{A}</math> supply current. Do not leave EN floating.
3	C2	GND	Ground. Power and IC ground. All signals are referenced to this pin.
4	C1	FB	Feedback/ V_{OUT} . Connect to output voltage.
5	B1	SW	Switching Node. Connect to output inductor.
6	A1	IC	For Internal Connection.
Exposed Pad	–	GND	Connect to GND.

ELECTRICAL CHARACTERISTICS

(Minimum and maximum values are at $V_{IN} = V_{EN} = 2.5V$ to $5.5V$, Full = $-40^{\circ}C$ to $+85^{\circ}C$; typical values are at $V_{IN} = V_{EN} = 3.6V$, $T_A = +25^{\circ}C$, unless otherwise noted.)

PARAMETER	SYMBOL	CONDITIONS	TEMP	MIN	TYP	MAX	UNITS
POWER SUPPLIES							
Input Voltage Range	V_{IN}		Full	2.5		5.5	V
Quiescent Current	I_Q	No Load, Not Switching	Full		22	40	μA
Shutdown Supply Current	I_{SD}	EN = GND	+25°C		0.45	1	μA
Under-Voltage Lockout Threshold	V_{UVLO}	Rising V_{IN}	+25°C		2.15	2.42	V
Under-Voltage Lockout Hysteresis	V_{UVHYS}		+25°C		150		mV
EN LOGIC INPUT							
Enable High-Level Input Voltage	V_{IH}		Full	1.5			V
Enable Low-Level Input Voltage	V_{IL}		Full			0.3	V
SWITCHING							
Switching Frequency	f_{SW}	$V_{IN} = 3.6V$	+25°C	5.5	6	6.5	MHz
OUTPUT							
Output Voltage	V_{OUT}	SGM6032-1.0	Full	0.980	1.000	1.043	V
		SGM6032-1.1	Full	1.055	1.100	1.124	
		SGM6032-1.15	Full	1.121	1.150	1.190	
		SGM6032-1.2	Full	1.148	1.200	1.226	
		SGM6032-1.5	Full	1.433	1.500	1.532	
		SGM6032-1.6	Full	1.543	1.600	1.641	
		SGM6032-1.8	Full	1.726	1.800	1.841	
		SGM6032-2.5	Full	2.378	2.500	2.527	
		SGM6032-2.8	Full	2.680	2.800	2.849	
SGM6032-3.0	Full	2.846	3.000	3.031			
Soft-Start	t_{SS}	From EN Rising Edge	+25°C		200		μs
OUTPUT DRIVER							
PMOS On-Resistance	$R_{DS(ON)}$	$V_{IN} = V_{GS} = 3.6V$	+25°C		350		m Ω
NMOS On-Resistance		$V_{IN} = V_{GS} = 3.6V$	+25°C		250		m Ω
PMOS Peak Current Limit	$I_{LIM(OL)}$		+25°C	1630	1900	2130	mA
Output Discharge Resistance	R_{DIS}	EN = GND	+25°C		230		Ω
Thermal Shutdown	T_{TSD}				160		°C
Thermal Shutdown Hysteresis	T_{HYS}				15		°C

TYPICAL PERFORMANCE CHARACTERISTICS

T_A = +25°C, V_{IN} = V_{EN} = 3.6V, unless otherwise noted.

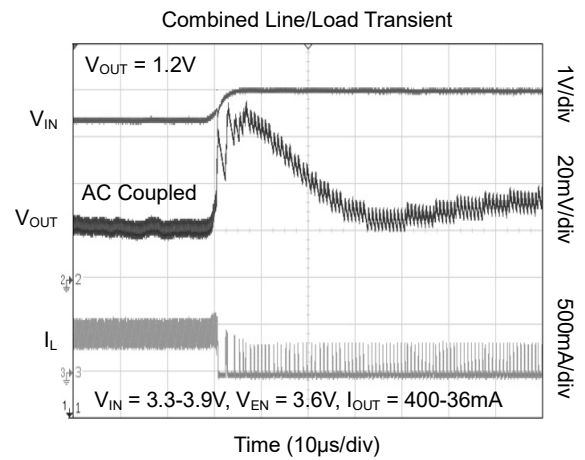
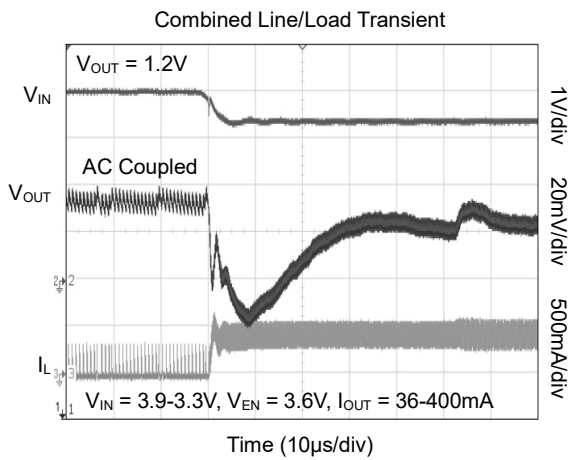
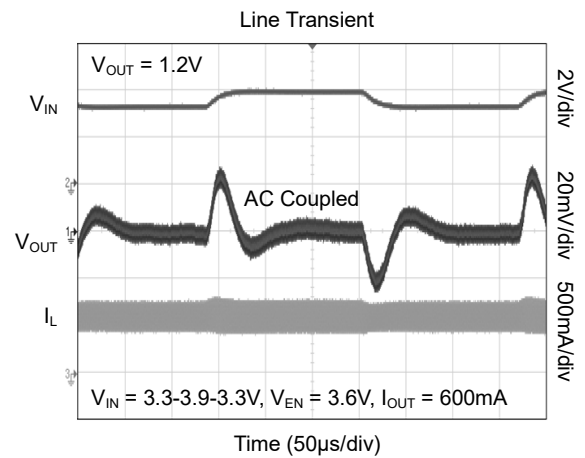
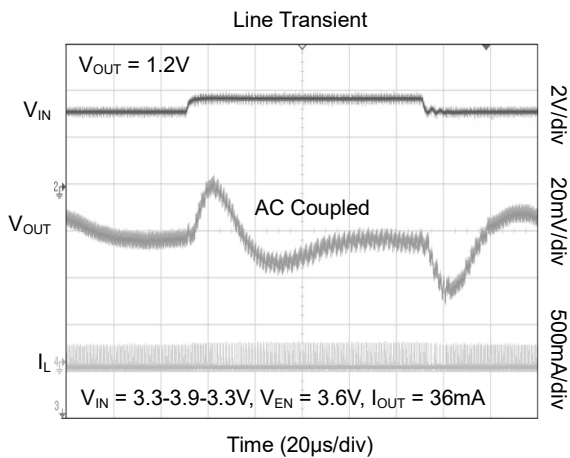
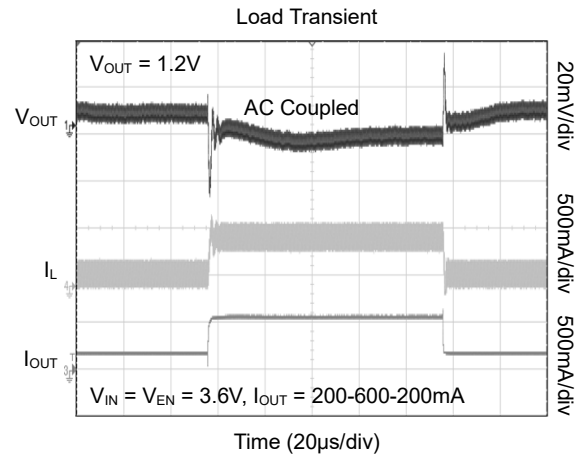
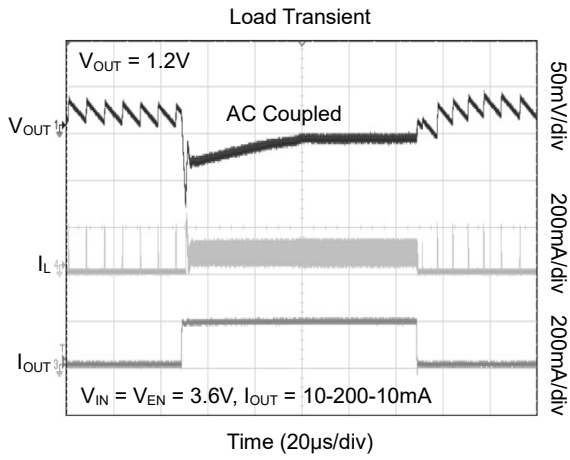

TYPICAL PERFORMANCE CHARACTERISTICS (continued)

T_A = +25°C, V_{IN} = V_{EN} = 3.6V, unless otherwise noted.

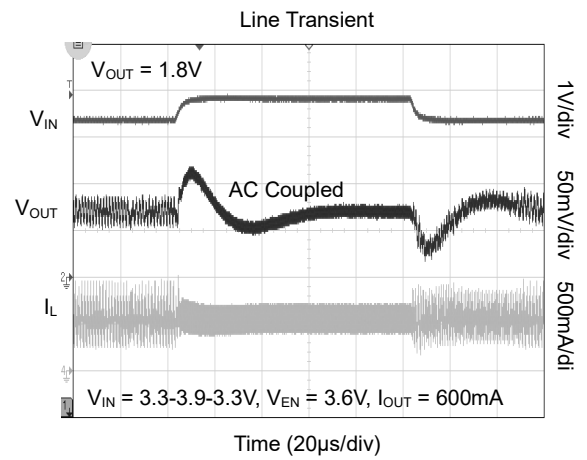
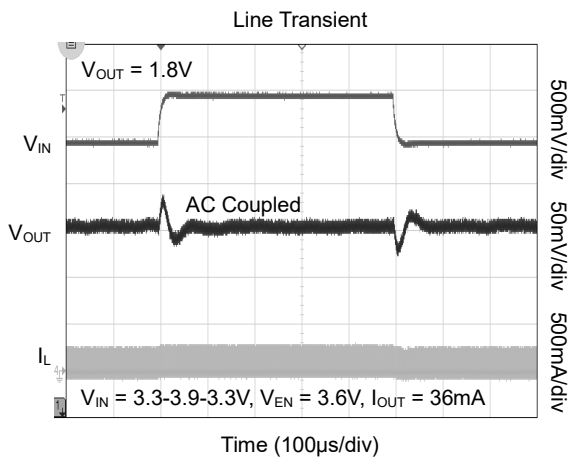
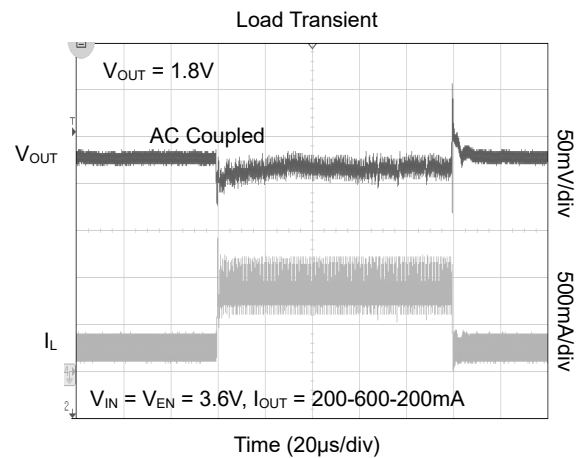
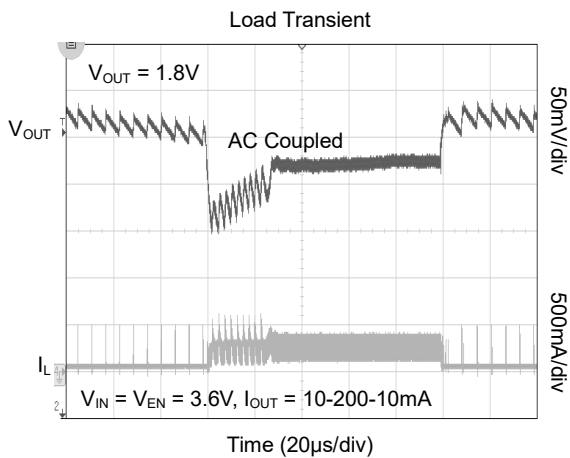
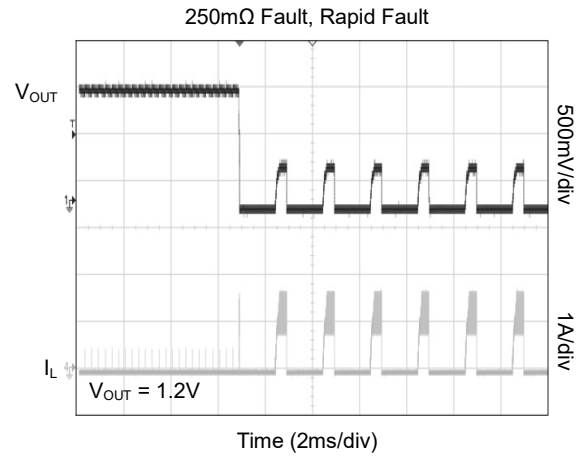
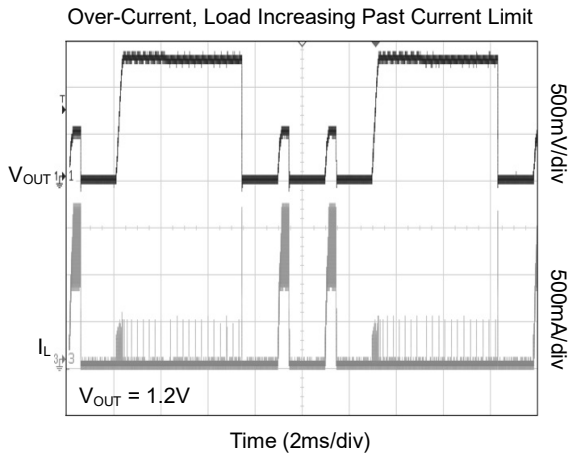

TYPICAL PERFORMANCE CHARACTERISTICS (continued)

$T_A = +25^\circ\text{C}$, $V_{IN} = V_{EN} = 3.6\text{V}$, unless otherwise noted.

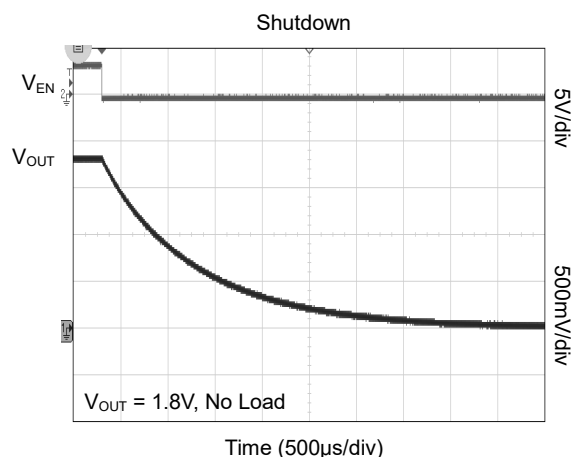
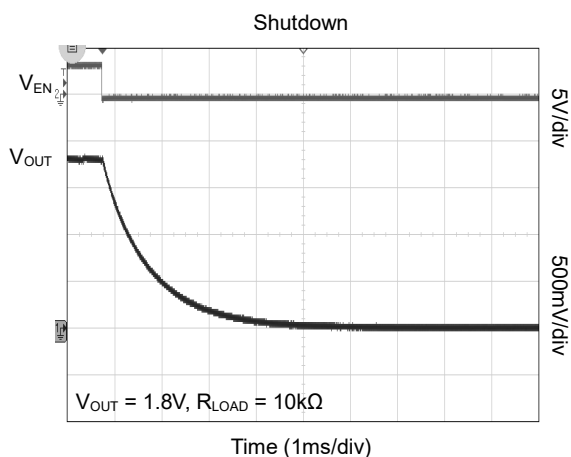
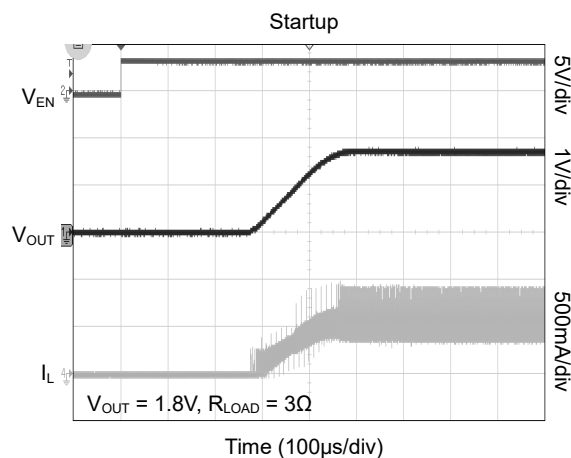
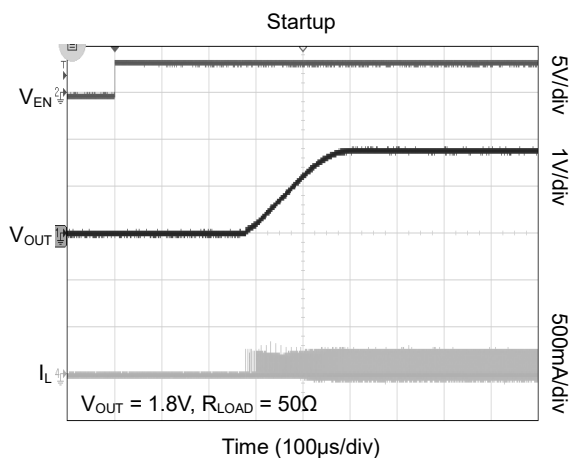

TYPICAL PERFORMANCE CHARACTERISTICS (continued)

T_A = +25°C, V_{IN} = V_{EN} = 3.6V, unless otherwise noted.

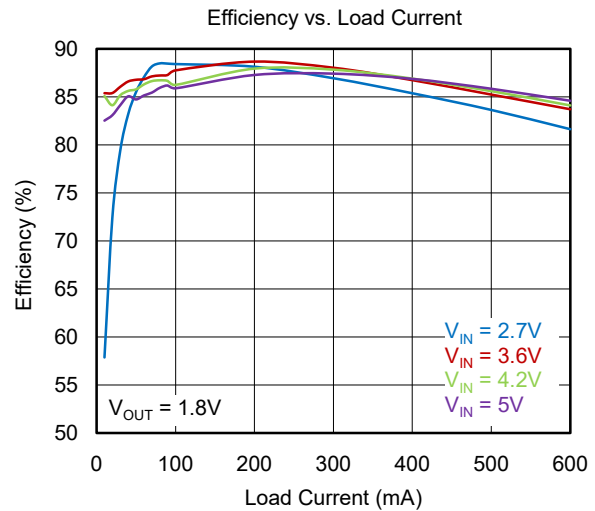
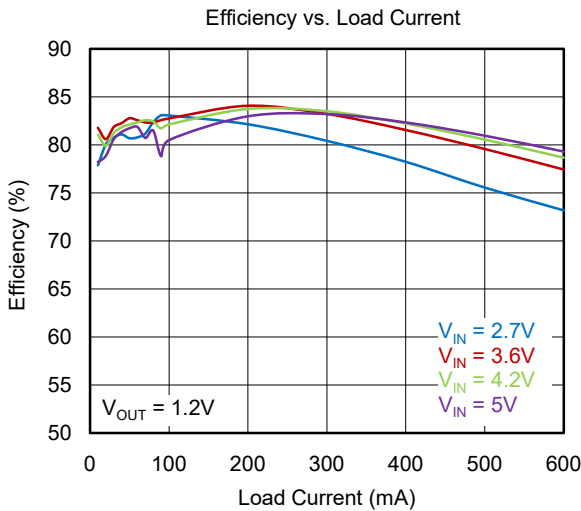
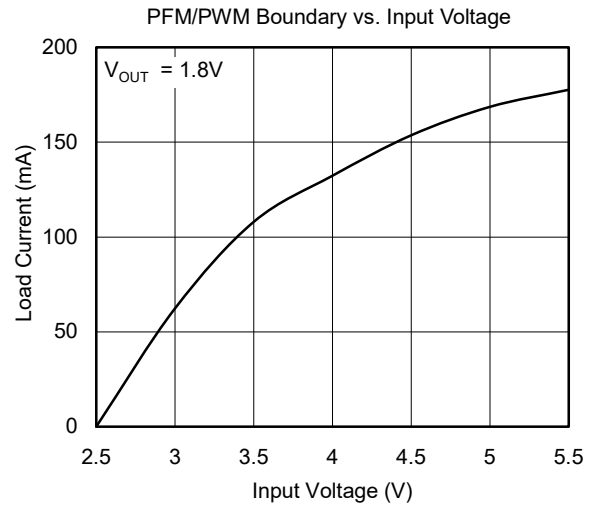
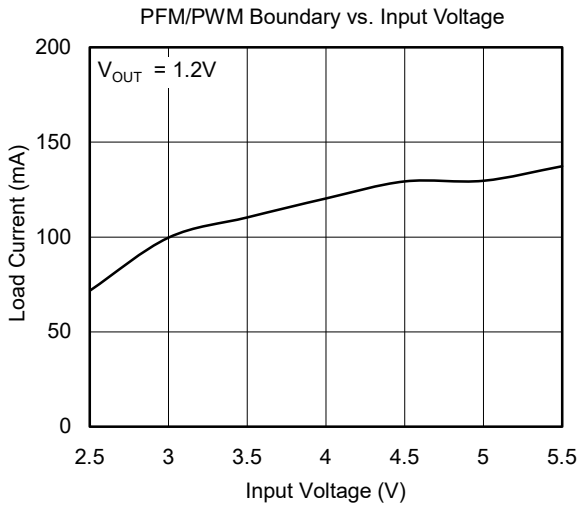
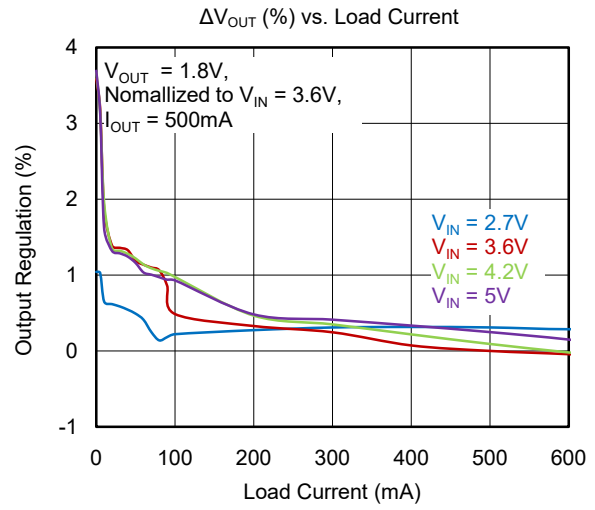
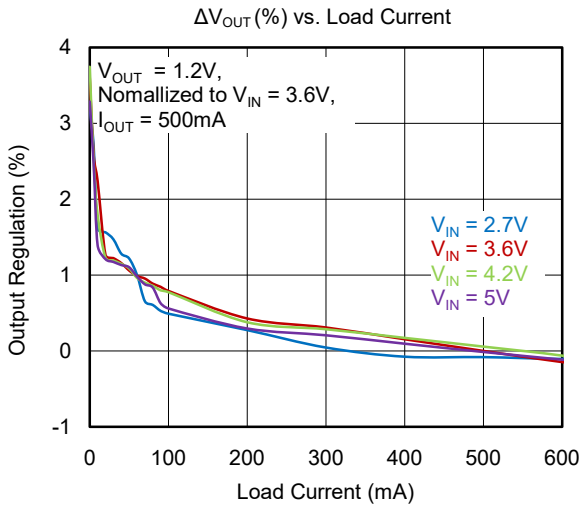

TYPICAL PERFORMANCE CHARACTERISTICS (continued)

T_A = +25°C, V_{IN} = V_{EN} = 3.6V, unless otherwise noted.

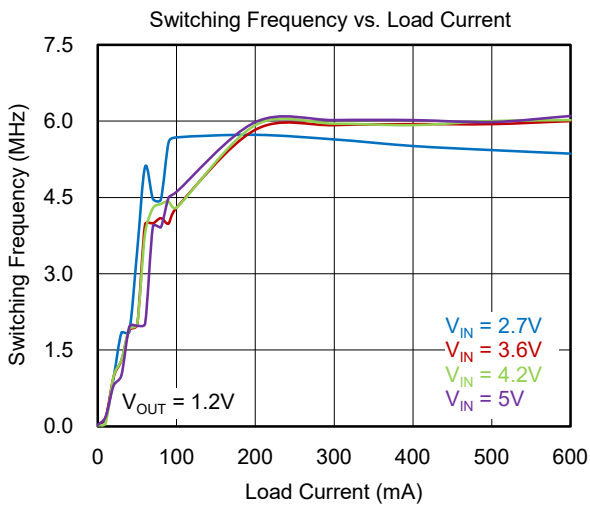
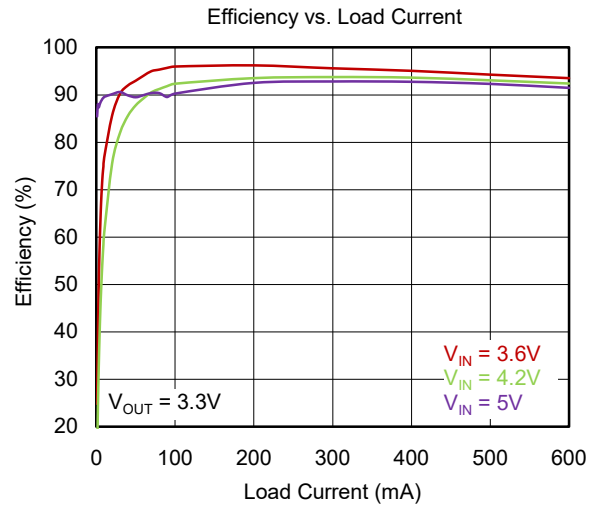
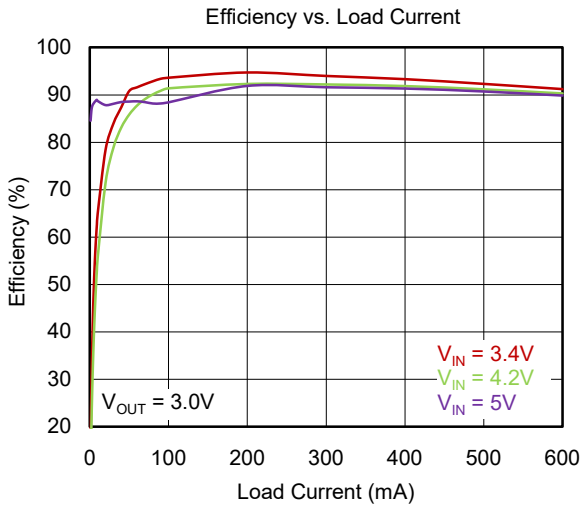
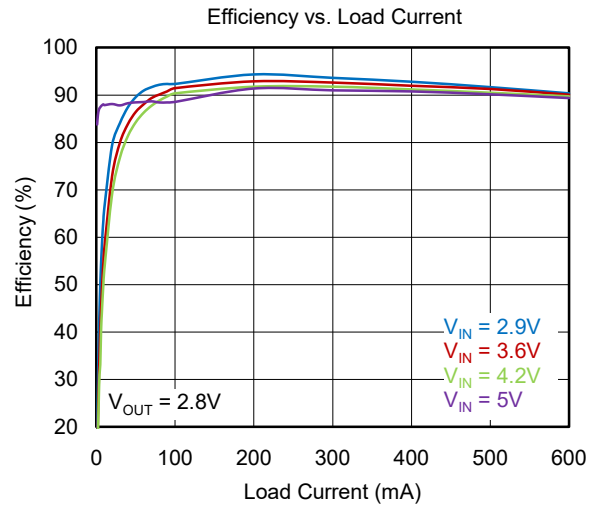
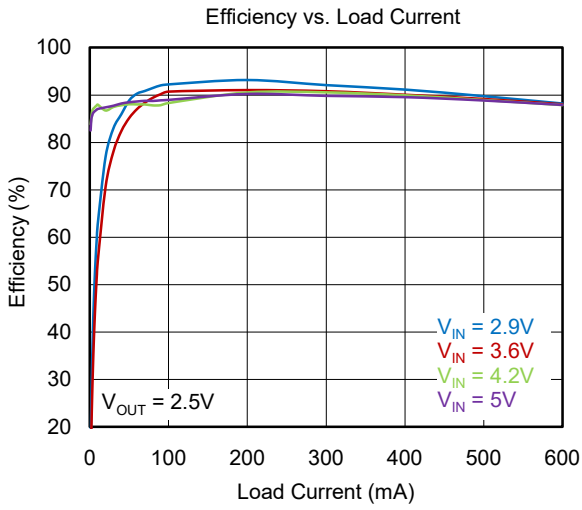

OPERATION DESCRIPTION

The SGM6032 is a 6MHz, step-down switching voltage regulator available in 600mA option that delivers a fixed output from an input voltage supply of 2.5V to 5.5V. Using an architecture with synchronous rectification, the SGM6032 is capable of delivering a peak efficiency of 90%, while maintaining efficiency over 80% at load currents as low as 1mA.

The regulator operates at a nominal fixed frequency of 6MHz, which reduces the value of the external components to as low as 470nH for the output inductor and 4.7 μ F for the output capacitor. In addition, the PWM modulator can be synchronized to an external frequency source.

Control Scheme

The SGM6032 uses a non-linear, fixed-frequency PWM modulator to deliver a fast load transient response, while maintaining a constant switching frequency over a wide range of operating conditions. The regulator performance is independent of the output capacitor ESR, allowing for the use of ceramic output capacitors. Although this type of operation normally results in a switching frequency that varies with input voltage and load current, an internal frequency loop holds the switching frequency constant over a large range of input voltages and load currents.

For very light loads, the SGM6032 operates in PFM mode. Transition between PWM and PFM is seamless, allowing for a smooth transition between DCM and CCM.

Combined with exceptional transient response characteristics, the very low quiescent current of the controller maintains high efficiency; even at very light loads; while preserving fast transient response for applications requiring tight output regulation.

Soft-Start

Raising EN above its threshold voltage activates the part and starts the soft-start cycle. During soft-start, the internal reference is ramped using an exponential RC shape to prevent overshoot of the output voltage. Current limiting minimizes inrush during soft-start.

The current-limit fault response protects the IC in the event of an over-current condition present during soft-start. As a result, the IC may fail to start if heavy load is applied during startup.

Current Limit, Fault Shutdown, and Restart

A heavy load or short circuit on the output causes the current in the inductor to increase until a maximum current threshold is reached in the high-side switch. Upon reaching this point, the high-side switch turns off, preventing high currents from causing damage. The regulator triggers an over-current fault, causing the regulator to shut down for about 1.3ms, and the soft-start circuit attempts to restart and produces an over-current fault after about 200 μ s.

The closed-loop peak-current limit is not the same as the open-loop tested current limit, $I_{LIM(OL)}$, in the Electrical Characteristics table. This is primarily due to the effect of propagation delays of the IC current limit comparator.

Under-Voltage Lockout (UVLO)

When the input voltage is below the UVLO threshold, the device is shut down. If the input voltage rises above the UVLO threshold plus hysteresis, the IC will restart.

Thermal Shutdown (TSD)

A thermal shutdown function is implemented to prevent damage caused by excessive heat and power dissipation. Once a temperature of typically +160°C is exceeded, the device is shut down. The device is released from shutdown automatically when the junction temperature decreases by 15°C.

APPLICATION INFORMATION

Selecting the Inductor

The output inductor must meet both the required inductance and the energy-handling capability of the application. The inductor value affects average current limit, the PWM-to-PFM transition point, output voltage ripple, and efficiency.

The ripple current (ΔI) of the regulator is:

$$\Delta I \approx \frac{V_{OUT}}{V_{IN}} \cdot \left(\frac{V_{IN} - V_{OUT}}{L \cdot f_{SW}} \right) \quad (1)$$

The maximum average load current, $I_{MAX(Load)}$, is related to the peak current limit, $I_{LIM(PK)}$, by the ripple current, given by:

$$I_{MAX(Load)} = I_{LIM(PK)} - \left(\frac{\Delta I}{2} \right) \quad (2)$$

The transition between PFM and PWM operation is determined by the point at which the inductor valley current crosses zero. The regulator DC current when the inductor current crosses zero, I_{DCM} , is:

$$I_{DCM} = \frac{\Delta I}{2} \quad (3)$$

The SGM6032 is optimized for operation with $L = 470\text{nH}$, but is stable with inductances up to $1\mu\text{H}$ (nominal). The inductor should be rated to maintain at least 80% of its value at $I_{LIM(PK)}$.

Efficiency is affected by the inductor DCR and inductance value. Decreasing the inductor value for a given physical size typically decreases the DCR; but because ΔI increases, the RMS current increases, as do the core and skin effect losses.

$$I_{RMS} = \sqrt{I_{OUT(DC)}^2 + \frac{\Delta I^2}{12}} \quad (4)$$

The increased RMS current produces higher losses through the $R_{DS(ON)}$ of the IC MOSFETs, as well as the inductor DCR.

Increasing the inductor value produces lower RMS

currents, but degrades transient response. For a given physical inductor size, increased inductance usually results in an inductor with lower saturation current and higher DCR.

Table 1 shows the effects of inductance higher or lower than the recommended $1\mu\text{H}$ on regulator performance.

Table 1. Effects of Changes in Inductor Value (from 470nH Recommended Value) on Regulator Performance

INDUCTOR VALUE	$I_{MAX(Load)}$	ΔV_{OUT}	TRANSIENT RESPONSE
Increase	Increase	Decrease	Degraded
Decrease	Decrease	Increase	Improved

Output Capacitor

Table 2 suggests 0402 capacitors. 0603 capacitors may further improve performance in that the effective capacitance is higher. This improves transient response and output ripple.

Increasing C_{OUT} has no effect on loop stability and can therefore be increased to reduce output voltage ripple or to improve transient response. Output voltage ripple, ΔV_{OUT} , is:

$$\Delta V_{OUT} = \Delta I_L \left[\frac{f_{SW} \cdot C_{OUT} \cdot ESR^2}{2 \cdot D \cdot (1-D)} + \frac{1}{8 \cdot f_{SW} \cdot C_{OUT}} \right] \quad (5)$$

Input Capacitor

The $2.2\mu\text{F}$ ceramic input capacitor should be placed as close as possible between the V_{IN} pin and GND to minimize the parasitic inductance. If a long wire is used to bring power to the IC, additional "bulk" capacitance (electrolytic or tantalum) should be placed between C_{IN} and the power source lead to reduce the ringing that can occur between the inductance of the power source leads and C_{IN} .

The effective capacitance value decreases as V_{IN} increases due to DC bias effects.

Table 2. Recommended Passive Components and their Variation Due to DC Bias

COMPONENT	DESCRIPTION	VENDOR	MIN	TYP	MAX
L	470nH, 2012, 90mΩ, 1.1A	Murata LQM21PNR47MC0 Murata LQM21PNR54MG0 Hitachi Metals HLSI 201210R47	300nH	470nH	520nH
C_{IN}	2.2μF, 6.3V, X5R, 0402	Murata or Equivalent GRM155R60J225ME15 GRM188R60J225KE19D	1.0μF	2.2μF	
C_{OUT}	4.7μF, X5R, 0402	Murata or Equivalent GRM155R60G475M GRM155R60E475ME760	1.6μF	4.7μF	
C_{OUT} (SGM6032-0.6/ SGM6032-0.8 only)	10μF, X5R, 0402	Murata	10μF	22μF	

APPLICATION INFORMATION (continued)

PCB Layout Guidelines

There are only three external components: the inductor and the input and output capacitors. For any step-down switcher IC, including the SGM6032, it is important to place a low-ESR input capacitor very close to the IC, as shown in Figure 2. The input capacitor ensures good input decoupling, which helps reduce noise appearing at the output terminals and ensures that the control

sections of the IC do not behave erratically due to excessive noise. This reduces switching cycle jitter and ensures good overall performance. It is important to place the common GND of C_{IN} and C_{OUT} as close as possible to the C2 terminal. There is some flexibility in moving the inductor further away from the IC; in that case, V_{OUT} should be considered at the C_{OUT} terminal.

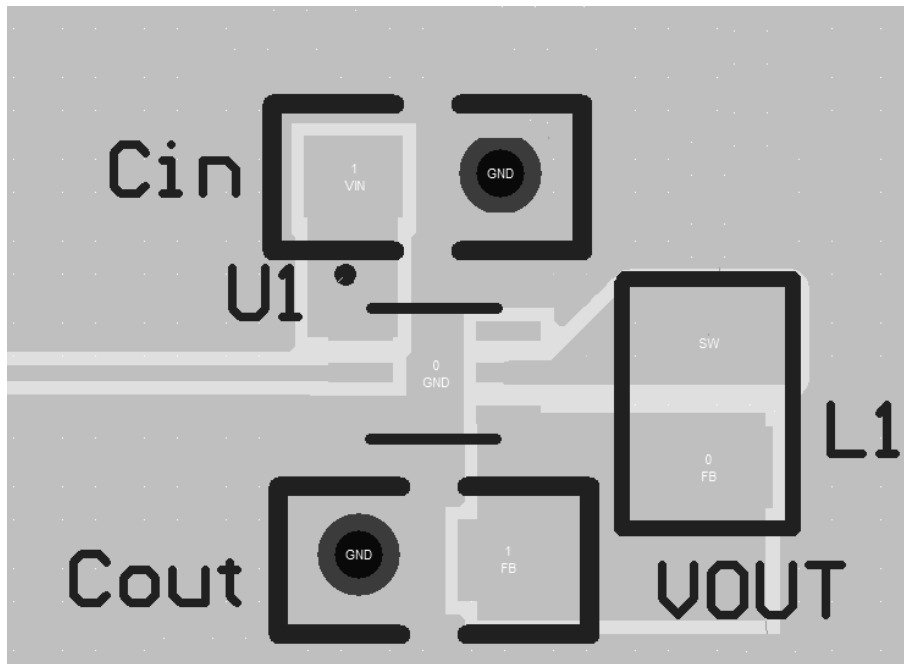

Figure 2. PCB Layout Guidance

REVISION HISTORY

NOTE: Page numbers for previous revisions may differ from page numbers in the current version.

JUNE 2018 – REV.A.2 to REV.A.3

Added Package Thermal Resistance	3
Updated Typical Performance Characteristics	10

FEBRUARY 2018 – REV.A.1 to REV.A.2

Updated Package/Ordering Information section	2
Added CDM	3
Updated Electrical Characteristics section	5
Updated Table 2	11

SEPTEMBER 2017 – REV.A to REV.A.1

Added WLCSP-1.21×0.81-6B package and SGM6032-1.6YTDI6G	All
--	-----

Changes from Original (APRIL 2017) to REV.A

Changed from product preview to production data	All
---	-----

PACKAGE OUTLINE DIMENSIONS

TDFN-2x2-6L

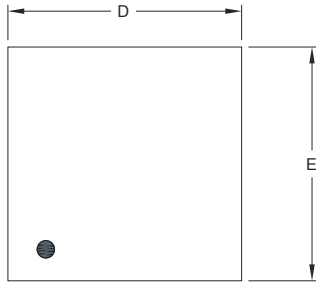

TOP VIEW

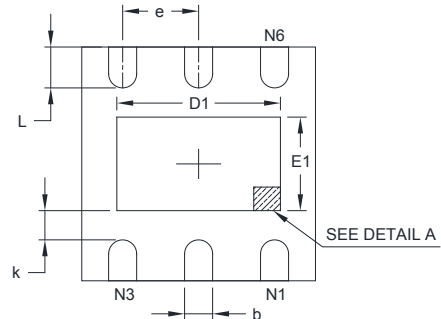

BOTTOM VIEW

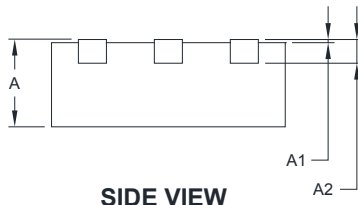

SIDE VIEW

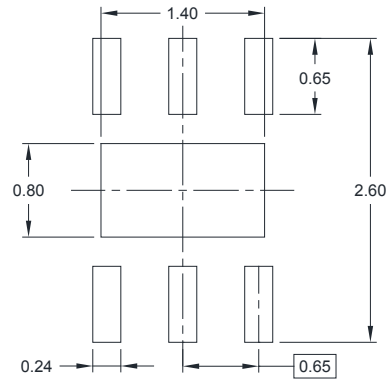

RECOMMENDED LAND PATTERN (Unit: mm)

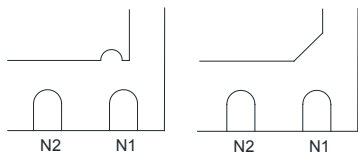

DETAIL A

Pin #1 ID and Tie Bar Mark Options

NOTE: The configuration of the Pin #1 identifier is optional, but must be located within the zone indicated.

Symbol	Dimensions In Millimeters		Dimensions In Inches	
	MIN	MAX	MIN	MAX
A	0.700	0.800	0.028	0.031
A1	0.000	0.050	0.000	0.002
A2	0.203 REF		0.008 REF	
D	1.900	2.100	0.075	0.083
D1	1.100	1.450	0.043	0.057
E	1.900	2.100	0.075	0.083
E1	0.600	0.850	0.024	0.034
k	0.200 MIN		0.008 MIN	
b	0.180	0.300	0.007	0.012
e	0.650 TYP		0.026 TYP	
L	0.250	0.450	0.010	0.018

PACKAGE OUTLINE DIMENSIONS

WLCSP-1.21×0.81-6B

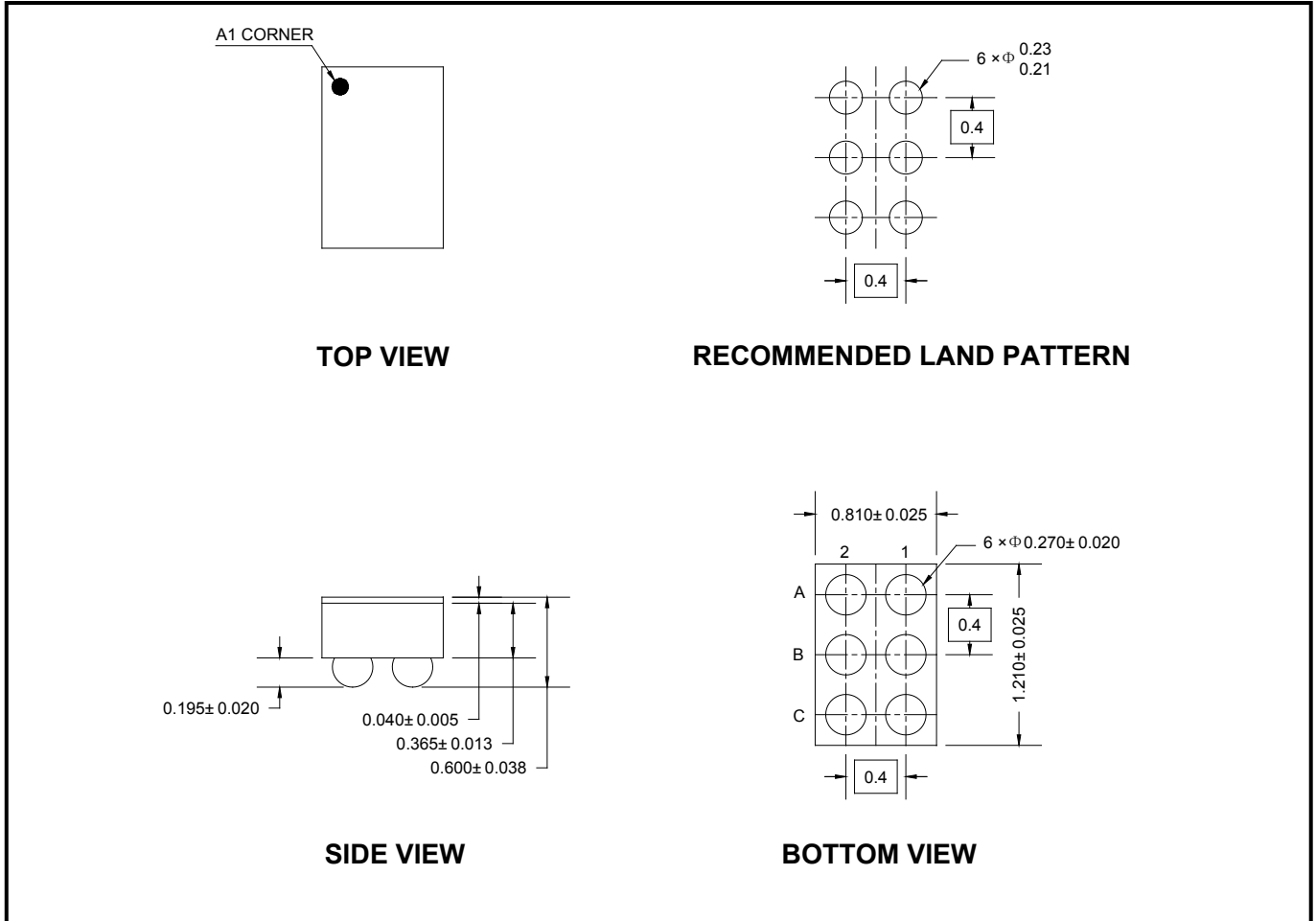

NOTE: All linear dimensions are in millimeters.

TAPE AND REEL INFORMATION

REEL DIMENSIONS



TAPE DIMENSIONS



NOTE: The picture is only for reference. Please make the object as the standard.

KEY PARAMETER LIST OF TAPE AND REEL

Package Type	Reel Diameter	Reel Width W1 (mm)	A0 (mm)	B0 (mm)	K0 (mm)	P0 (mm)	P1 (mm)	P2 (mm)	W (mm)	Pin1 Quadrant
TDFN-2×2-6L	7"	9.5	2.30	2.30	1.10	4.0	4.0	2.0	8.0	Q1
WLCSP-1.21×0.81-6B	7"	9.2	0.90	1.32	0.68	4.0	4.0	2.0	8.0	Q1

000001

PACKAGE INFORMATION

CARTON BOX DIMENSIONS



NOTE: The picture is only for reference. Please make the object as the standard.

KEY PARAMETER LIST OF CARTON BOX

Reel Type	Length (mm)	Width (mm)	Height (mm)	Pizza/Carton
7" (Option)	368	227	224	8
7"	442	410	224	18

DD0002