



SGM8705

Micro-Power, CMOS Input, RRIO, 1.4V, Push-Pull Output Comparator

GENERAL DESCRIPTION

The SGM8705 is a dual low power comparator with a typical power supply current of 300nA (per channel). It has the best-in-class power supply current versus propagation delay performance. The propagation delay is as low as 6 μ s with 100mV overdrive at 1.4V supply.

Designed to operate over a wide range of supply voltages, from 1.4V to 5.5V, with guaranteed operation at 1.4V, 2.5V and 5.0V, the SGM8705 is ideal for use in a variety of battery-powered applications. With rail-to-rail common mode voltage range, the SGM8705 is well suited for single-supply operation. Its small packages make this device ideal for use in handheld electronics and mobile phone applications.

Featuring a push-pull output stage, the SGM8705 allows for operation with absolute minimum power consumption when driving any capacitive or resistive load.

SGM8705 is available in Green SOIC-8 and MSOP-8 packages. It is rated over the -40°C to +85°C temperature range.

FEATURES

- **Ultra Low Power Consumption:**
300nA/Channel (TYP) at $V_S = 1.4V$
- **Wide Supply Voltage Range: 1.4V to 5.5V**
- **Propagation Delay: 6 μ s (TYP) at $V_S = 1.4V$**
- **Push-Pull Output Current Drive:**
19mA (TYP) at $V_S = 5V$
- **Rail-to-Rail Input**
- **-40°C to +85°C Operating Temperature Range**
- **Available in Green SOIC-8 and MSOP-8 Packages**

APPLICATIONS

RC Timers
Window Detectors
IR Receiver
Multivibrators
Alarm and Monitoring Circuits

SGM8705

Micro-Power, CMOS Input, RRIO, 1.4V, Push-Pull Output Comparator

PACKAGE/ORDERING INFORMATION

MODEL	PIN-PACKAGE	SPECIFIED TEMPERATURE RANGE	ORDERING NUMBER	PACKAGE MARKING	PACKAGE OPTION
SGM8705	SOIC-8	-40°C to +85°C	SGM8705YS8G/TR	SGM8705YS8	Tape and Reel, 2500
	MSOP-8	-40°C to +85°C	SGM8705YMS8G/TR	SGM8705YMS8	Tape and Reel, 3000

ABSOLUTE MAXIMUM RATINGS

Supply Voltage, +V _S to -V _S	6V
V _{IN} Differential.....	±2.5V
Voltage at Input/Output pins.....	(-V _S) - 0.3V to (+V _S) + 0.3V
Operating Temperature Range.....	-40°C to +85°C
Junction Temperature.....	150°C
Storage Temperature.....	-65°C to +150°C
Lead Temperature (soldering, 10s)	260°C
ESD Susceptibility	
HBM.....	4000V
MM.....	400V

NOTE:

Stresses beyond those listed under “Absolute Maximum Ratings” may cause permanent damage to the device. These are stress ratings only, and functional operation of the device at these or any other conditions beyond those indicated in the operational sections of the specifications is not implied. Exposure to absolute maximum rating conditions for extended periods may affect device reliability.

PIN CONFIGURATIONS (TOP VIEW)

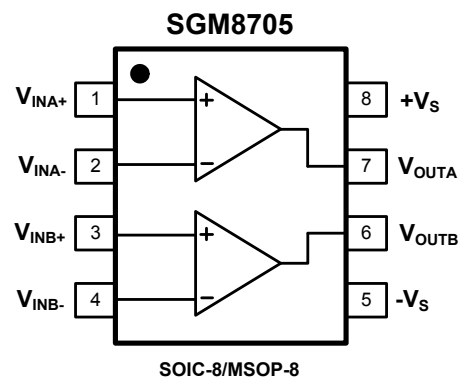

CAUTION

This integrated circuit can be damaged by ESD if you don't pay attention to ESD protection. SGMICRO recommends that all integrated circuits be handled with appropriate precautions. Failure to observe proper handling and installation procedures can cause damage. ESD damage can range from subtle performance degradation to complete device failure. Precision integrated circuits may be more susceptible to damage because very small parametric changes could cause the device not to meet its published specifications.

SGMICRO reserves the right to make any change in circuit design, specification or other related things if necessary without notice at any time. Please contact SGMICRO sales office to get the latest datasheet.

ELECTRICAL CHARACTERISTICS: $V_S = 1.4V$ (At $T_A = 25^\circ C$, $+V_S = 1.4V$, $-V_S = 0V$, $V_{CM} = +V_S/2$, and $V_O = -V_S$, unless otherwise noted.)

PARAMETER	SYMBOL	CONDITIONS	MIN	TYP	MAX	UNITS
Supply Current (per channel)	I_S	$V_{CM} = 0.3V$		300	1000	nA
		$V_{CM} = 1.1V$		250	1000	
Input Offset Voltage	V_{OS}	$V_{CM} = 0V$	-3	0.5	3	mV
		$V_{CM} = 1.4V$	-3	0.5	3	
Input Offset Average Drift				2		$\mu V/^\circ C$
Common Mode Rejection Ratio	CMRR	V_{CM} Stepped from 0V to 0.3V		65		dB
		V_{CM} Stepped from 0.8V to 1.4V		75		
		V_{CM} Stepped from 0V to 1.4V		75		
Power Supply Rejection Ratio	PSRR	$V_S = 1.8V$ to 5.5V, $V_{CM} = 0V$	66	95		dB
Large Signal Voltage Gain	A_{VO}			100		dB
Output Swing High	V_{OH}	$V_S = 1.8V$, $I_O = 500\mu A$	1.598	1.669		V
		$-40^\circ C \leq T_A \leq +85^\circ C$	1.581			
		$V_S = 1.8V$, $I_O = 1mA$	1.324	1.508		
		$-40^\circ C \leq T_A \leq +85^\circ C$	1.288			
Output Swing Low	V_{OL}	$V_S = 1.8V$, $I_O = -500\mu A$		82	112	mV
		$-40^\circ C \leq T_A \leq +85^\circ C$			127	
		$V_S = 1.8V$, $I_O = -1mA$		167	225	
		$-40^\circ C \leq T_A \leq +85^\circ C$			253	
Output Current	I_{OUT}	Source		0.7		mA
		Sink		2.0		
Propagation Delay (High to Low)		Overdrive = 10mV		12		μs
		Overdrive = 100mV		6		
Propagation Delay (Low to High)		Overdrive = 10mV		26		μs
		Overdrive = 100mV		17		
Rise Time	t_{Rise}	Overdrive = 10mV, $C_L = 30pF$, $R_L = 1M\Omega$		220		ns
		Overdrive = 100mV, $C_L = 30pF$, $R_L = 1M\Omega$		220		
Fall Time	t_{Fall}	Overdrive = 10mV, $C_L = 30pF$, $R_L = 1M\Omega$		155		ns
		Overdrive = 100mV, $C_L = 30pF$, $R_L = 1M\Omega$		155		

ELECTRICAL CHARACTERISTICS: $V_S = 2.5V$ (At $T_A = 25^\circ C$, $+V_S = 2.5V$, $-V_S = 0V$, $V_{CM} = +V_S/2$, and $V_O = -V_S$, unless otherwise noted.)

PARAMETER	SYMBOL	CONDITIONS	MIN	TYP	MAX	UNITS
Supply Current (per channel)	I_S	$V_{CM} = 0.3V$		310	1200	nA
		$V_{CM} = 2.2V$		260	1200	
Input Offset Voltage	V_{OS}	$V_{CM} = 0V$	-3	0.5	3	mV
		$V_{CM} = 2.5V$	-3	0.5	3	
Input Offset Average Drift				2		$\mu V/^\circ C$
Common Mode Rejection Ratio	CMRR	V_{CM} Stepped from 0V to 1.4V		75		dB
		V_{CM} Stepped from 1.9V to 2.5V		80		
		V_{CM} Stepped from 0V to 2.5V		80		
Power Supply Rejection Ratio	PSRR	$V_S = 1.8V$ to $5.5V$, $V_{CM} = 0V$	66	95		dB
Large Signal Voltage Gain	A_{VO}			100		dB
Output Swing High	V_{OH}	$I_O = 500\mu A$	2.376	2.419		V
		$-40^\circ C \leq T_A \leq +85^\circ C$	2.366			
		$I_O = 1mA$	2.254	2.333		
		$-40^\circ C \leq T_A \leq +85^\circ C$	2.227			
Output Swing Low	V_{OL}	$I_O = -500\mu A$		66	87	mV
		$-40^\circ C \leq T_A \leq +85^\circ C$			97	
		$I_O = -1mA$		133	168	
		$-40^\circ C \leq T_A \leq +85^\circ C$			188	
Output Current	I_{OUT}	Source	3.5	5.3		mA
		$-40^\circ C \leq T_A \leq +85^\circ C$	2.6			
		Sink	6.0	7.7		
		$-40^\circ C \leq T_A \leq +85^\circ C$	4.6			
Propagation Delay (High to Low)		Overdrive = 10mV		12		μs
		Overdrive = 100mV		5		
Propagation Delay (Low to High)		Overdrive = 10mV		28		μs
		Overdrive = 100mV		19		
Rise Time	t_{Rise}	Overdrive = 10mV, $C_L = 30pF$, $R_L = 1M\Omega$		120		ns
		Overdrive = 100mV, $C_L = 30pF$, $R_L = 1M\Omega$		120		
Fall Time	t_{Fall}	Overdrive = 10mV, $C_L = 30pF$, $R_L = 1M\Omega$		85		ns
		Overdrive = 100mV, $C_L = 30pF$, $R_L = 1M\Omega$		70		

ELECTRICAL CHARACTERISTICS: $V_S = 5.0V$ (At $T_A = 25^\circ C$, $+V_S = 5.0V$, $-V_S = 0V$, $V_{CM} = +V_S/2$, and $V_O = -V_S$, unless otherwise noted.)

PARAMETER	SYMBOL	CONDITIONS	MIN	TYP	MAX	UNITS
Supply Current (per channel)	I_S	$V_{CM} = 0.3V$		350	1500	nA
		$V_{CM} = 4.7V$		300	1500	
Input Offset Voltage	V_{OS}	$V_{CM} = 0V$	-3	0.5	3	mV
		$V_{CM} = 5V$	-3	0.5	3	
Input Offset Average Drift				2		$\mu V/^\circ C$
Common Mode Rejection Ratio	CMRR	V_{CM} Stepped from 0V to 3.9V		85		dB
		V_{CM} Stepped from 4.4V to 5.0V		85		
		V_{CM} Stepped from 0V to 5.0V		85		
Power Supply Rejection Ratio	PSRR	$V_S = 1.8V$ to 5.5V, $V_{CM} = 0V$	66	95		dB
Large Signal Voltage Gain	A_{VO}			105		dB
Output Swing High	V_{OH}	$I_O = 500\mu A$	4.923	4.952		V
		$-40^\circ C \leq T_A \leq +85^\circ C$	4.916			
		$I_O = 1mA$	4.864	4.904		
		$-40^\circ C \leq T_A \leq +85^\circ C$	4.848			
Output Swing Low	V_{OL}	$I_O = -500\mu A$		52	80	mV
		$-40^\circ C \leq T_A \leq +85^\circ C$			90	
		$I_O = -1mA$		104	130	
		$-40^\circ C \leq T_A \leq +85^\circ C$			143	
Output Current	I_{OUT}	Source	14	18		mA
		$-40^\circ C \leq T_A \leq +85^\circ C$	12.1			
		Sink	15	19		
		$-40^\circ C \leq T_A \leq +85^\circ C$	12.9			
Propagation Delay (High to Low)		Overdrive = 10mV		13		μs
		Overdrive = 100mV		6		
Propagation Delay (Low to High)		Overdrive = 10mV		42		μs
		Overdrive = 100mV		33		
Rise Time	t_{Rise}	Overdrive = 10mV, $C_L = 30pF$, $R_L = 1M\Omega$		85		ns
		Overdrive = 100mV, $C_L = 30pF$, $R_L = 1M\Omega$		85		
Fall Time	t_{Fall}	Overdrive = 10mV, $C_L = 30pF$, $R_L = 1M\Omega$		70		ns
		Overdrive = 100mV, $C_L = 30pF$, $R_L = 1M\Omega$		60		

SIMPLIFIED SCHEMATIC DIAGRAM

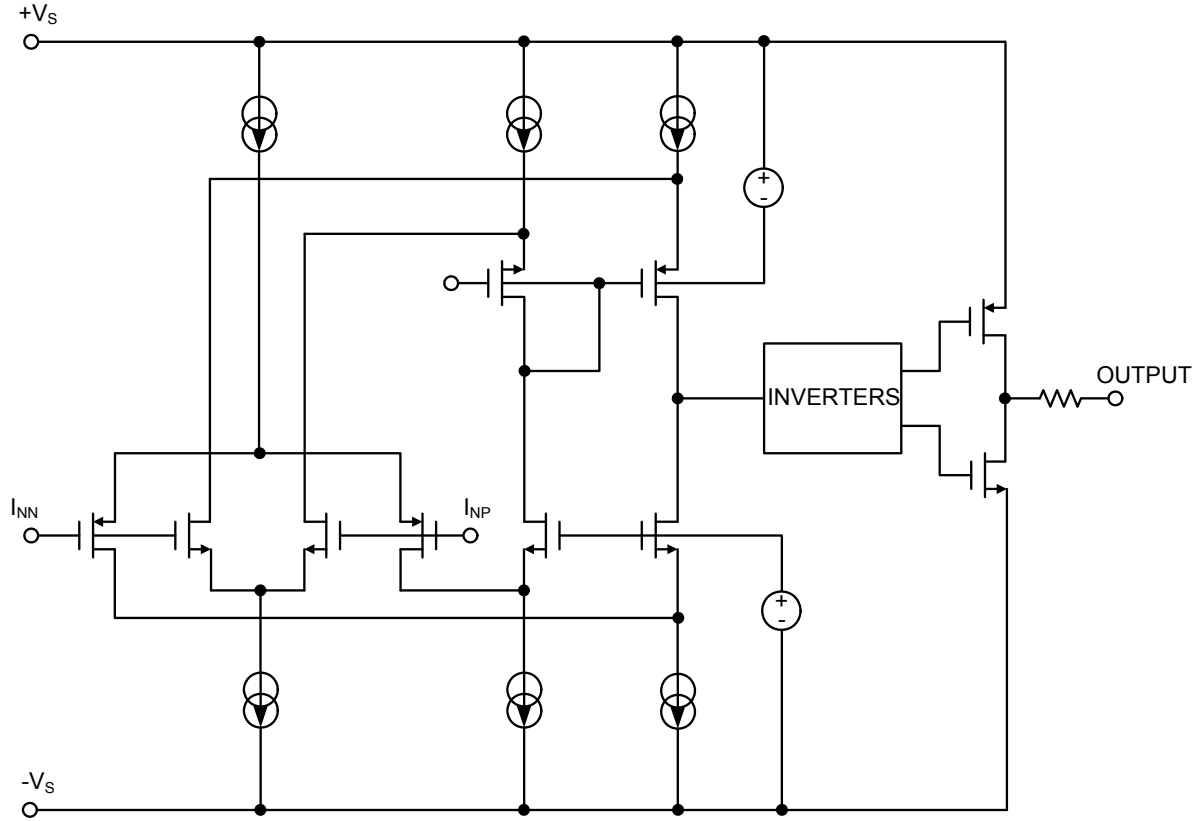

TYPICAL PERFORMANCE CHARACTERISTICS

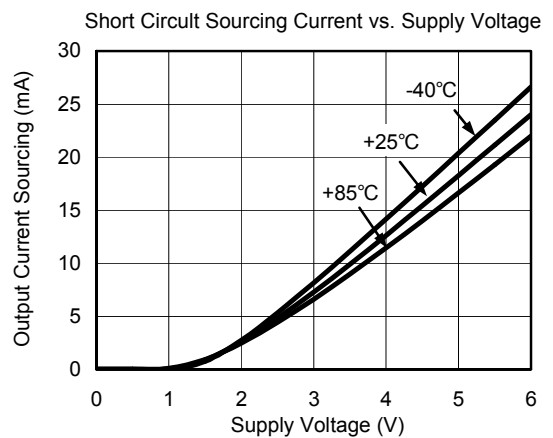
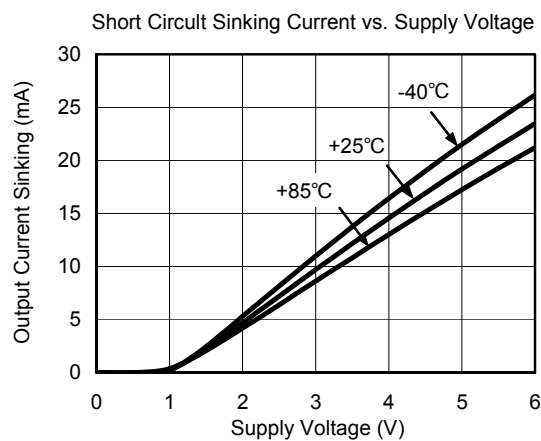
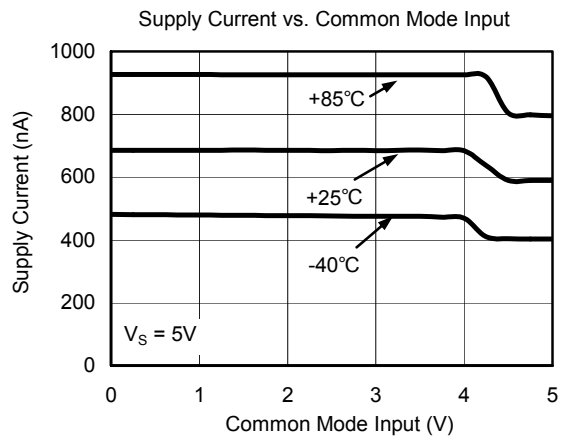
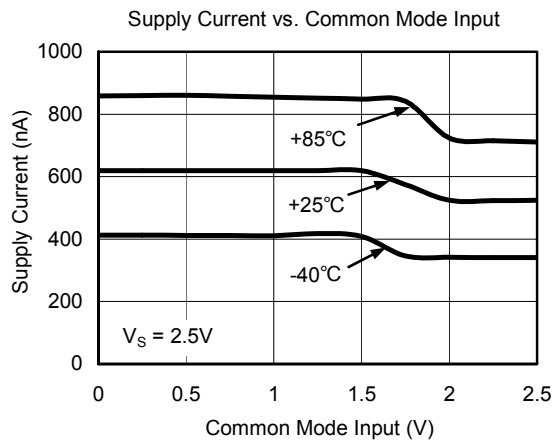
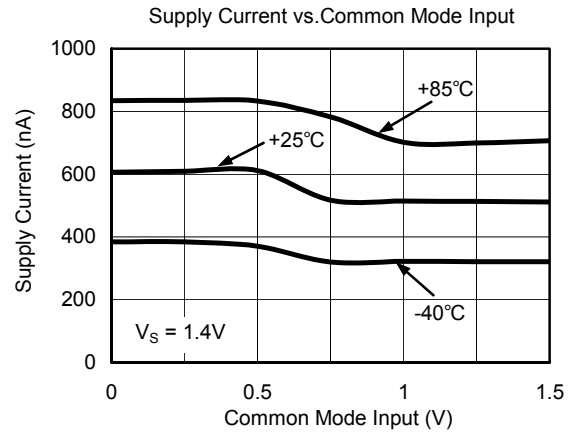
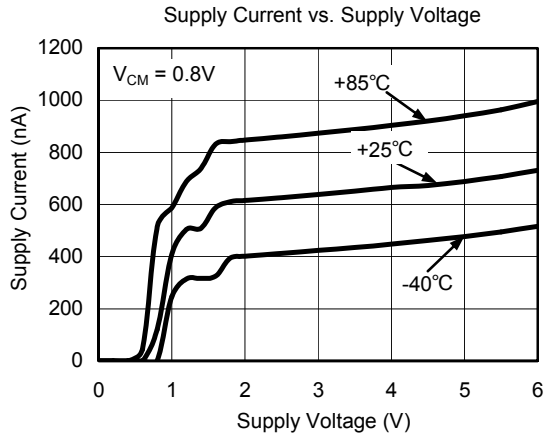

TYPICAL PERFORMANCE CHARACTERISTICS

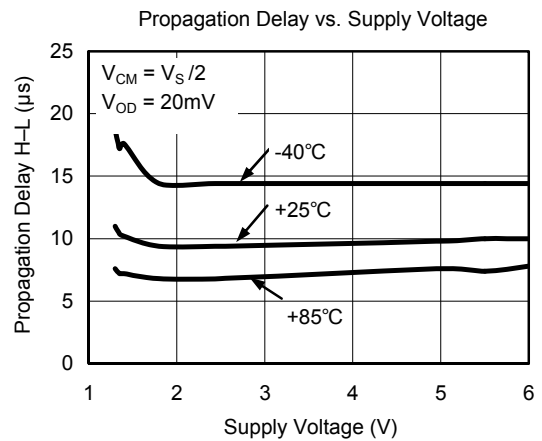
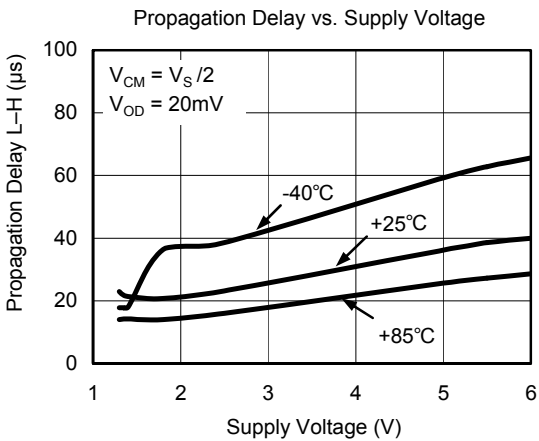
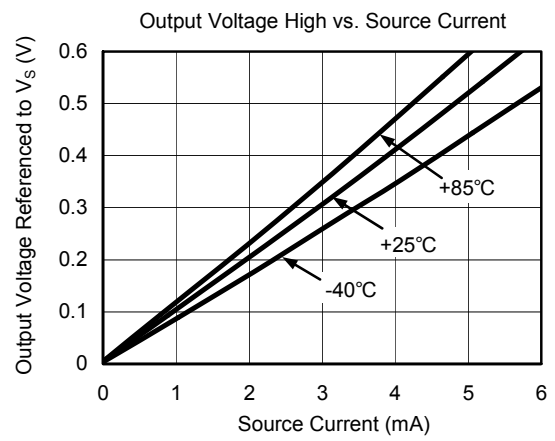
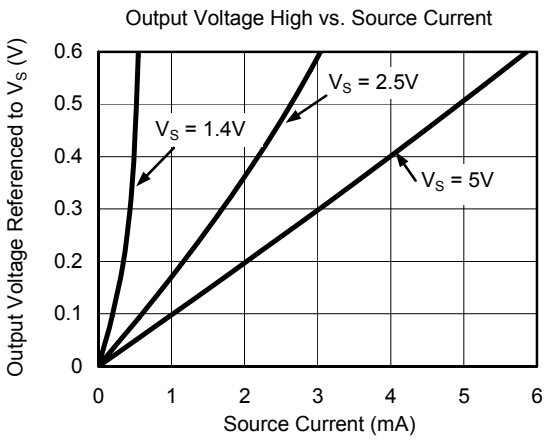
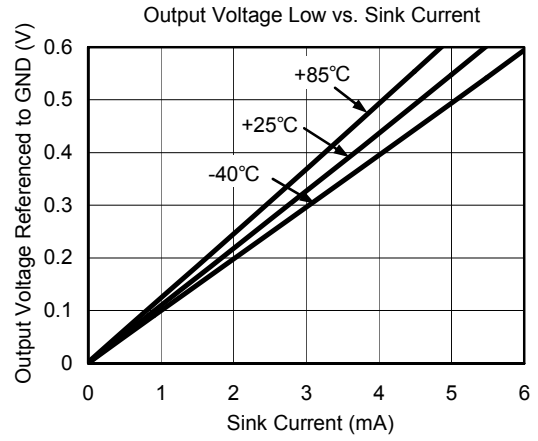
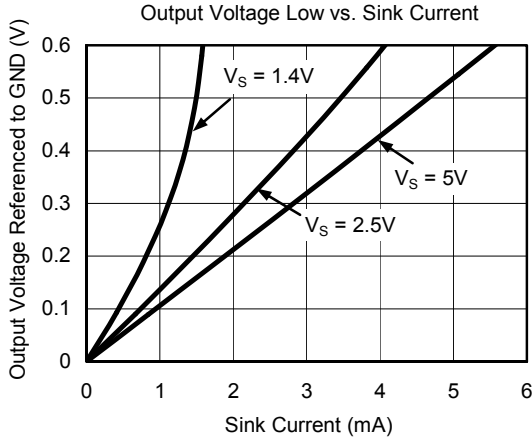

TYPICAL PERFORMANCE CHARACTERISTICS

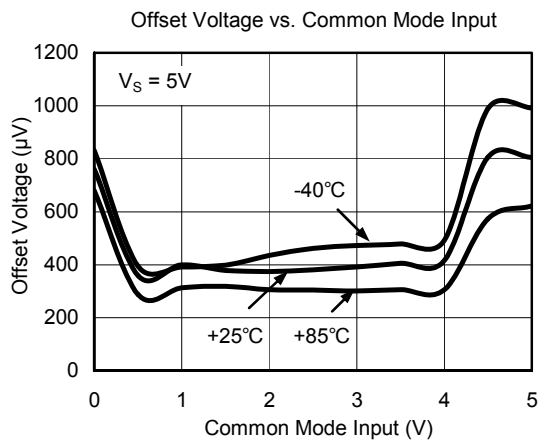
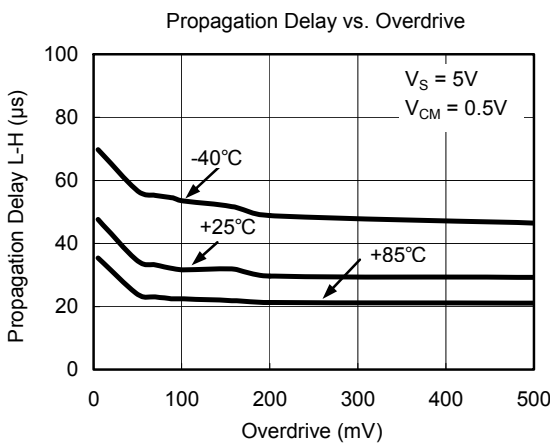
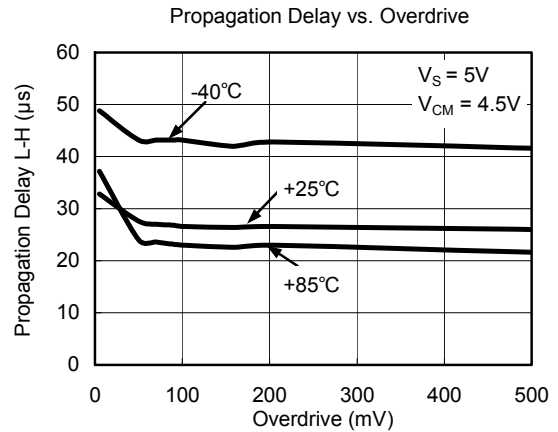
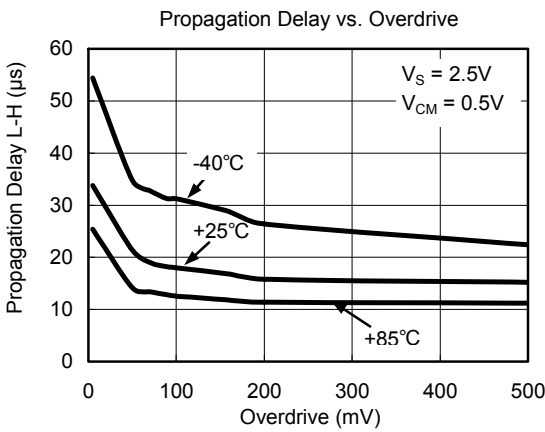
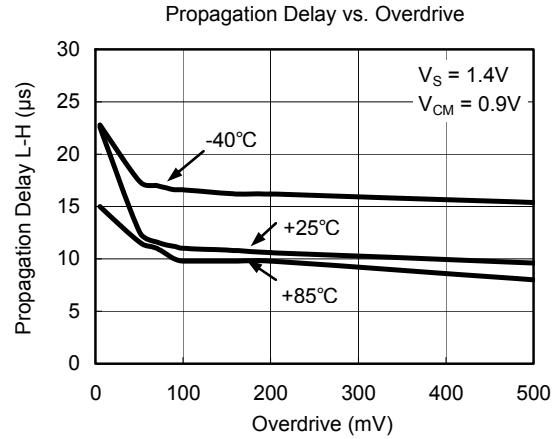
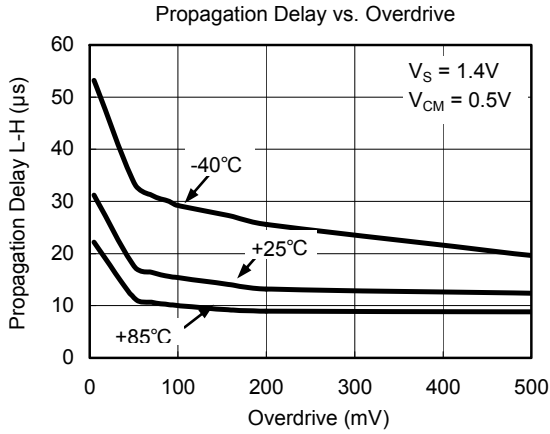

TYPICAL PERFORMANCE CHARACTERISTICS

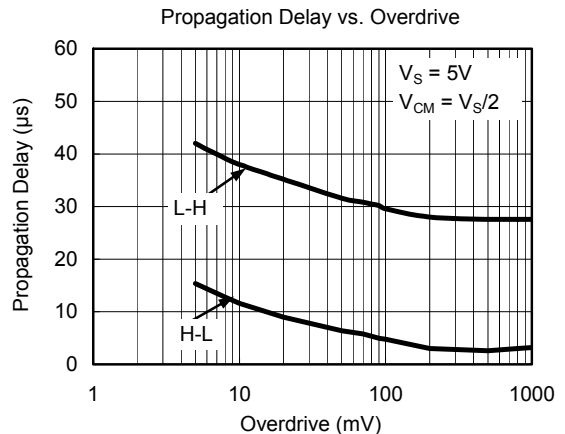
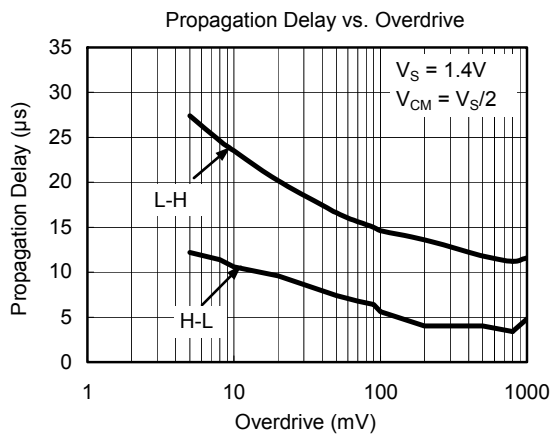
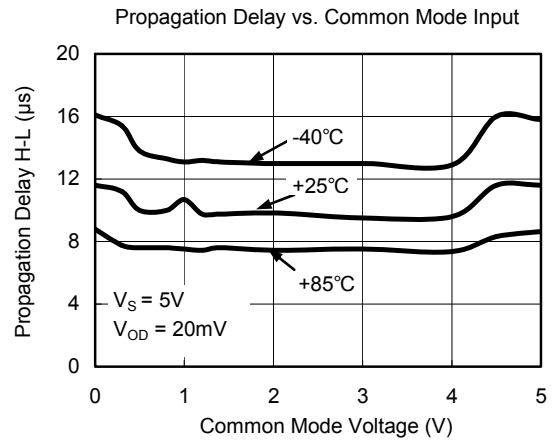
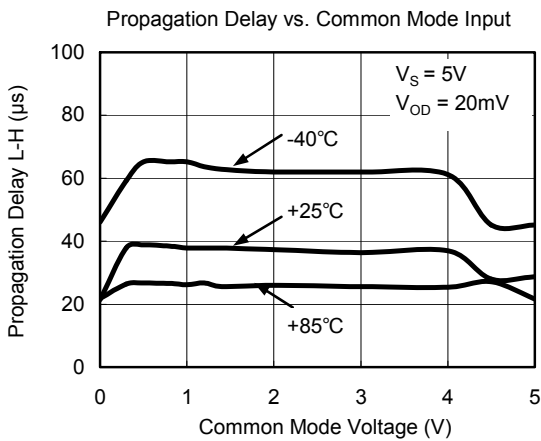
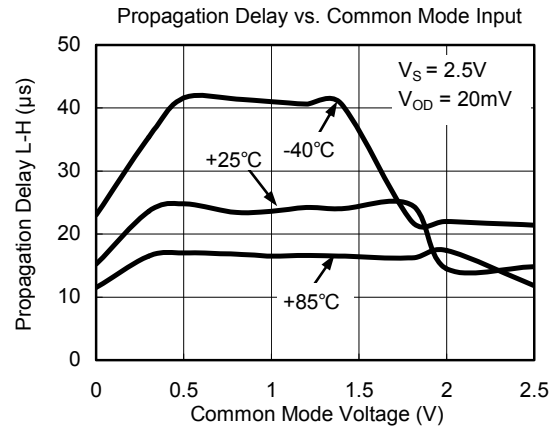
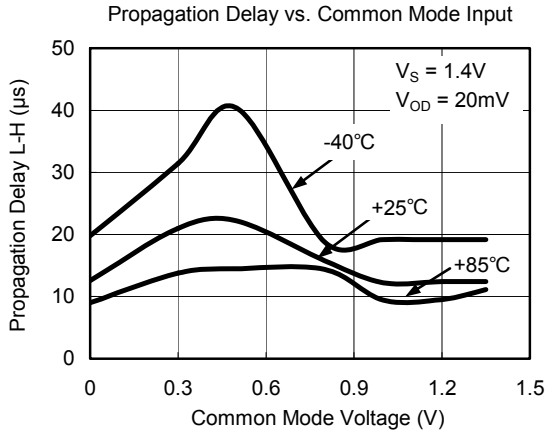

TYPICAL PERFORMANCE CHARACTERISTICS

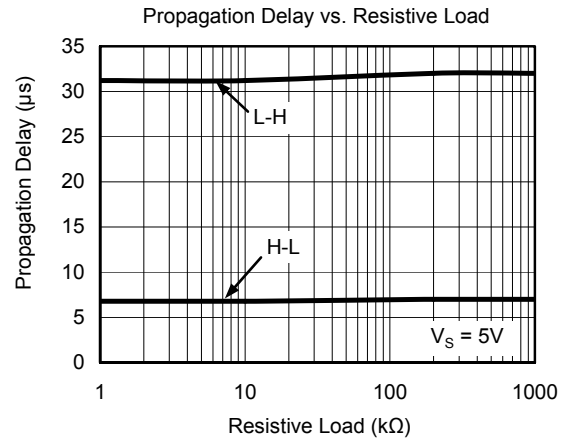
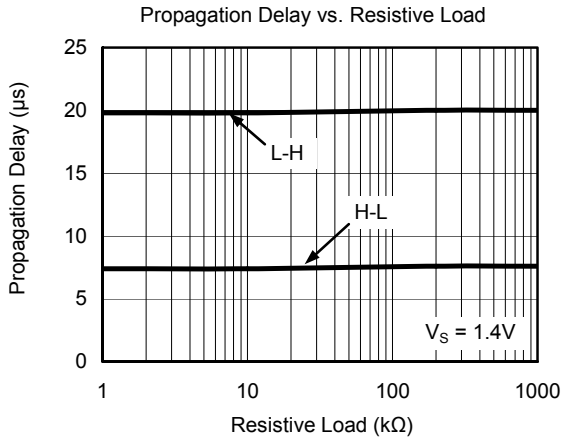

PACKAGE OUTLINE DIMENSIONS

SOIC-8

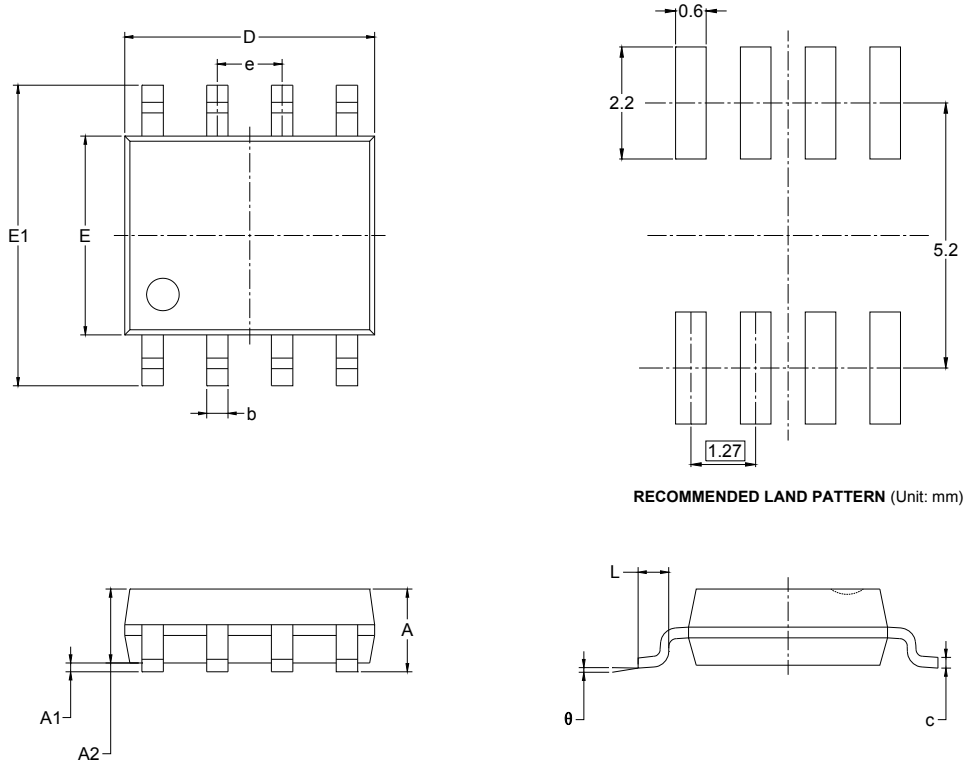

Symbol	Dimensions In Millimeters		Dimensions In Inches	
	MIN	MAX	MIN	MAX
A	1.350	1.750	0.053	0.069
A1	0.100	0.250	0.004	0.010
A2	1.350	1.550	0.053	0.061
b	0.330	0.510	0.013	0.020
c	0.170	0.250	0.006	0.010
D	4.700	5.100	0.185	0.200
E	3.800	4.000	0.150	0.157
E1	5.800	6.200	0.228	0.244
e	1.27 BSC		0.050 BSC	
L	0.400	1.270	0.016	0.050
θ	0°	8°	0°	8°

PACKAGE OUTLINE DIMENSIONS

MSOP-8

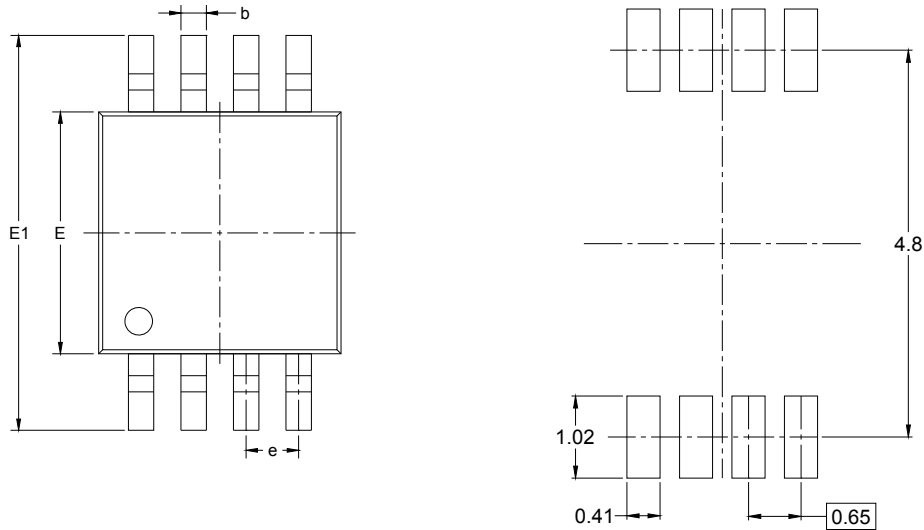

RECOMMENDED LAND PATTERN (Unit: mm)

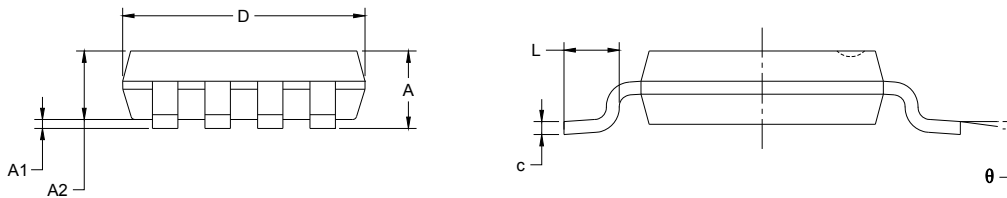

Symbol	Dimensions In Millimeters		Dimensions In Inches	
	MIN	MAX	MIN	MAX
A	0.820	1.100	0.032	0.043
A1	0.020	0.150	0.001	0.006
A2	0.750	0.950	0.030	0.037
b	0.250	0.380	0.010	0.015
c	0.090	0.230	0.004	0.009
D	2.900	3.100	0.114	0.122
E	2.900	3.100	0.114	0.122
E1	4.750	5.050	0.187	0.199
e	0.650 BSC		0.026 BSC	
L	0.400	0.800	0.016	0.031
θ	0°	6°	0°	6°

TAPE AND REEL INFORMATION

REEL DIMENSIONS

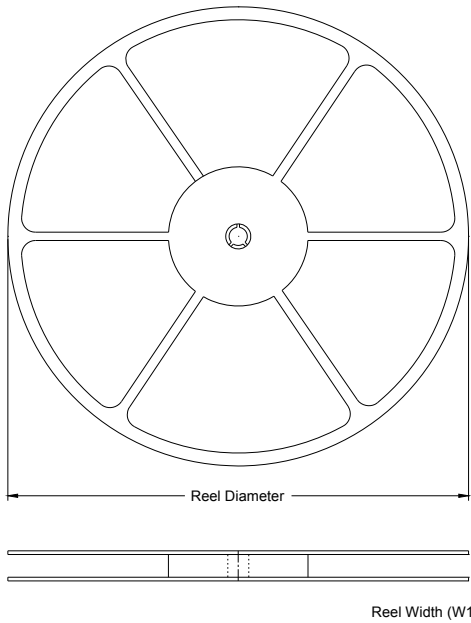

TAPE DIMENSIONS

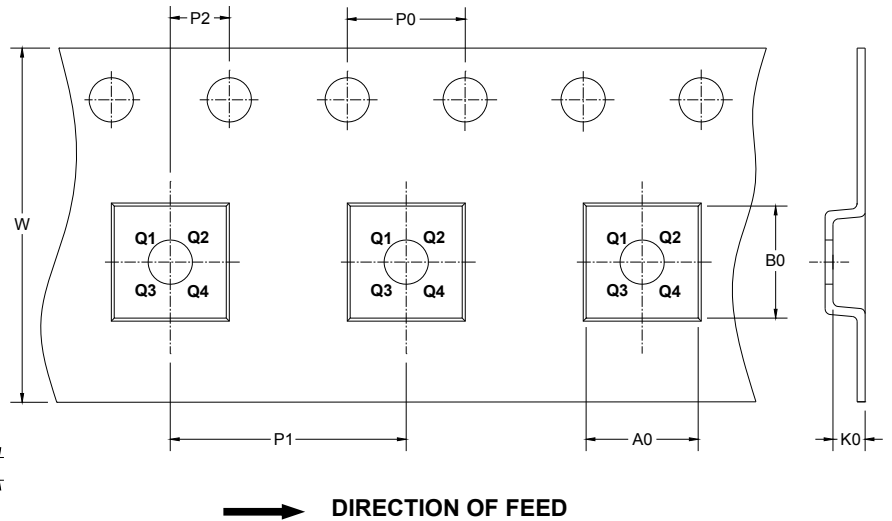

NOTE: The picture is only for reference. Please make the object as the standard.

KEY PARAMETER LIST OF TAPE AND REEL

Package Type	Reel Diameter	Reel Width W1 (mm)	A0 (mm)	B0 (mm)	K0 (mm)	P0 (mm)	P1 (mm)	P2 (mm)	W (mm)	Pin1 Quadrant
SOIC-8	13"	12.4	6.4	5.4	2.1	4.0	8.0	2.0	12.0	Q1
MSOP-8	13"	12.4	5.2	3.3	1.5	4.0	8.0	2.0	12.0	Q1

SGM8705

Micro-Power, CMOS Input, RRIO, 1.4V, Push-Pull Output Comparator

CARTON BOX DIMENSIONS

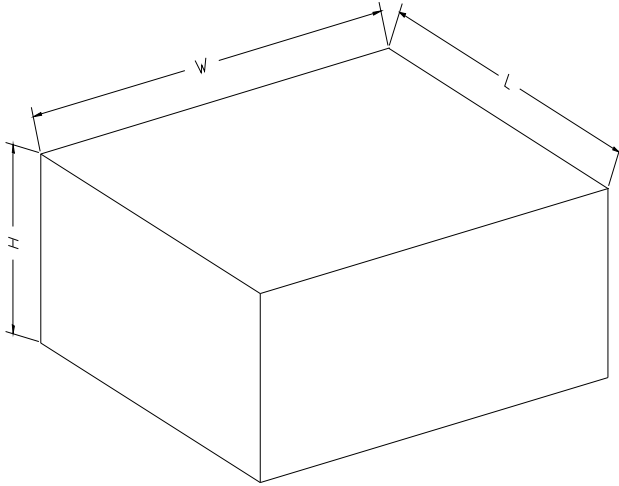

NOTE: The picture is only for reference. Please make the object as the standard.

KEY PARAMETER LIST OF CARTON BOX

Reel Type	Length (mm)	Width (mm)	Height (mm)	Pizza/Carton
13"	386	280	370	5