



## SGM8710

### Micro-Power, RRIO, 1.8V, Open Drain Output Comparator with Integrated Voltage Reference

---

#### GENERAL DESCRIPTION

The SGM8710 is an open drain output low power comparator with a typical power supply current of 2.2 $\mu$ A. It features an uncommitted on-chip voltage reference, comparator input common mode range of 200mV beyond the supply rails, and single-supply operation from 1.8V to 5.5V. The integrated 1.2V series voltage reference offers low 42 $\mu$ V/ $^{\circ}$ C drift, is stable with up to 10nF capacitive load, and can source up to 2mA (TYP) of output current.

Designed to operate over a wide range of supply voltages, from 1.8V to 5.5V, with guaranteed operation at 1.8V and 5.0V, the SGM8710 is ideal for use in a variety of battery-powered applications. With rail-to-rail input common mode voltage range, the SGM8710 is well suited for single-supply operation. Its small packages make this device ideal for use in handheld electronics and mobile phone applications.

Featuring an open drain output stage and having a latch enable input ( $\overline{LE}$ ), the SGM8710 allows for operation with absolute minimum power consumption when driving any capacitive or resistive load.

SGM8710 is available in Green SOT-23-6 and SOT-23-8 packages. It is rated over the -40 $^{\circ}$ C to +85 $^{\circ}$ C temperature range.

#### FEATURES

- **Low Power Consumption:**  
2.2 $\mu$ A (TYP) at  $V_S = 1.8V$
- **Wide Supply Voltage Range: 1.8V to 5.5V**
- **Open Drain Output Current Drive:**  
18mA (TYP) at  $V_S = 5V$
- **Rail-to-Rail Input**
- **Latch Function Included**
- **Integrated 1.2V Voltage Reference**
- **-40 $^{\circ}$ C to +85 $^{\circ}$ C Operating Temperature Range**
- **Available in Green SOT-23-6 and SOT-23-8 Packages**

#### APPLICATIONS

RC Timers  
Window Detectors  
IR Receiver  
Multi-vibrators  
Alarm and Monitoring Circuits

# SGM8710

# Micro-Power, RRIO, 1.8V, Open Drain Output Comparator with Integrated Voltage Reference

## PACKAGE/ORDERING INFORMATION

MODEL	PIN-PACKAGE	SPECIFIED TEMPERATURE RANGE	ORDERING NUMBER	PACKAGE MARKING	PACKAGE OPTION
SGM8710	SOT-23-8	-40°C to +85°C	SGM8710YN8G/TR	SS3XX	Tape and Reel, 3000
	SOT-23-6	-40°C to +85°C	SGM8710YN6G/TR	SS4XX	Tape and Reel, 3000

NOTE: XX = Date Code.

## MARKING INFORMATION

SYX X

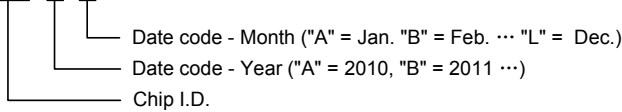

For example: SS3CA (2012, January)

## ABSOLUTE MAXIMUM RATINGS

Supply Voltage, +V <sub>S</sub> to -V <sub>S</sub> .....	6V
V <sub>IN</sub> Differential.....	±(+V <sub>S</sub> - (-V <sub>S</sub> ))
Voltage at Input/Output Pins.....	(-V <sub>S</sub> ) - 0.3V to (+V <sub>S</sub> ) + 0.3V
Operating Temperature Range.....	-40°C to +85°C
Junction Temperature.....	150°C
Storage Temperature Range.....	-65°C to +150°C
Lead Temperature (Soldering, 10s) .....	260°C
ESD Susceptibility	
HBM.....	3000V
MM.....	300V

### NOTE:

Stresses beyond those listed under "Absolute Maximum Ratings" may cause permanent damage to the device. These are stress ratings only, and functional operation of the device at these or any other conditions beyond those indicated in the operational sections of the specifications is not implied. Exposure to absolute maximum rating conditions for extended periods may affect device reliability.

## CAUTION

This integrated circuit can be damaged by ESD if you don't pay attention to ESD protection. SGMICRO recommends that all integrated circuits be handled with appropriate precautions. Failure to observe proper handling and installation procedures can cause damage. ESD damage can range from subtle performance degradation to complete device failure. Precision integrated circuits may be more susceptible to damage because very small parametric changes could cause the device not to meet its published specifications.

SGMICRO reserves the right to make any change in circuit design, specification or other related things if necessary without notice at any time. Please contact SGMICRO sales office to get the latest datasheet.

## PIN CONFIGURATIONS (TOP VIEW)

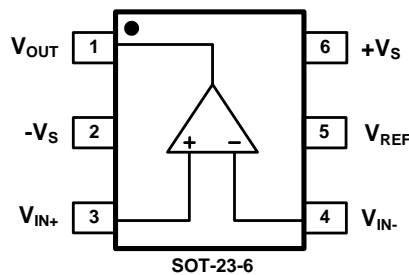
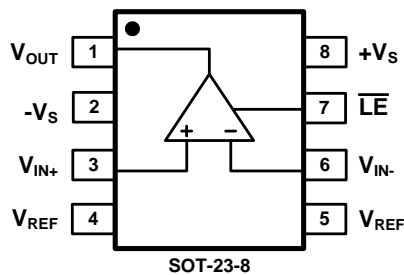

**ELECTRICAL CHARACTERISTICS:  $V_S = 1.8V$** (At  $T_A = +25^\circ C$ ,  $+V_S = 1.8V$ ,  $-V_S = 0V$ ,  $V_{LE} = 1.8V$ ,  $V_{CM} = +V_S/2$ , unless otherwise noted.)

PARAMETER	SYMBOL	CONDITIONS	MIN	TYP	MAX	UNITS
Supply Current	$I_S$	$I_O = 0$		2.2	3.8	$\mu A$
Input Offset Voltage	$V_{OS}$	$V_{CM} = 0V$		0.5	3	mV
		$V_{CM} = 1.8V$		0.5	3	
Input Offset Average Drift				2		$\mu V/^\circ C$
Common Mode Rejection Ratio	CMRR	$V_{CM} = 0V$ to $1.8V$	55	68		dB
Power Supply Rejection Ratio	PSRR	$V_S = 1.8V$ to $5.5V$ , $V_{CM} = 0V$	74	102		dB
Power Supply Ramp-Up Rate <sup>(1)</sup>			5			V/s
Latch Enable Pin High Input Voltage	$V_{IH}$		1.0			V
Latch Enable Pin Low Input Voltage	$V_{IL}$				0.25	V
Latch Enable Pin Bias Current	$I_{IH}, I_{IL}$	$V_{LE} = 0V$ or $V_{LE} = 1.8V$ , $V_{CM} = 0V$		3		nA
Large Signal Voltage Gain	$A_{VO}$			100		dB
Output Swing Low	$V_{OL}$	$I_O = -500\mu A$		84	124	mV
		$I_O = -500\mu A$ , $-40^\circ C \leq T_A \leq +85^\circ C$			163	
		$I_O = -1mA$		173	249	
		$I_O = -1mA$ , $-40^\circ C \leq T_A \leq +85^\circ C$			347	
Output Current	$I_{OUT}$	Sink		-3.5	-2.0	mA
		Sink, $-40^\circ C \leq T_A \leq +85^\circ C$			-1.4	
Propagation Delay (High to Low)	$t_{PD}$	Overdrive = 10mV		11.7		$\mu s$
		Overdrive = 100mV		5.6		
Fall Time	$t_{FALL}$	Overdrive = 10mV, $C_L = 30pF$ , $R_L = 1M\Omega$		75		ns
		Overdrive = 100mV, $C_L = 30pF$ , $R_L = 1M\Omega$		50		
Noise of $V_{REF}$		$f = 0.1Hz$ to $10Hz$		0.3		$mV_{P-P}$
<b>VOLTAGE REFERENCE</b>						
Reference Voltage	$V_{REF}$	$I_{REF} = 0mA$	1.182	1.200	1.218	V
Reference Voltage Drift				42		$\mu V/^\circ C$
Reference Output Current (Source)				2		mA

**ELECTRICAL CHARACTERISTICS:  $V_S = 5.0V$** (At  $T_A = +25^\circ C$ ,  $+V_S = 5V$ ,  $-V_S = 0V$ ,  $V_{LE} = 5V$ ,  $V_{CM} = +V_S/2$ , unless otherwise noted.)

PARAMETER	SYMBOL	CONDITIONS	MIN	TYP	MAX	UNITS
Supply Current	$I_S$	$I_O = 0$		2.3	4.4	$\mu A$
Input Offset Voltage	$V_{OS}$	$V_{CM} = 0V$		0.5	3	mV
		$V_{CM} = 5V$		0.5	3	
Input Offset Average Drift				2		$\mu V/^\circ C$
Common Mode Rejection Ratio	CMRR	$V_{CM} = 0V$ to $5V$	63	76		dB
Power Supply Rejection Ratio	PSRR	$V_S = 1.8V$ to $5.5V$ , $V_{CM} = 0V$	74	102		dB
Power Supply Ramp-Up Rate <sup>(1)</sup>			5			V/s
Latch Enable Pin High Input Voltage	$V_{IH}$		2			V
Latch Enable Pin Low Input Voltage	$V_{IL}$				0.8	V
Latch Enable Pin Bias Current	$I_{IH}, I_{IL}$	$V_{LE} = 0V$ or $V_{LE} = 5V$ , $V_{CM} = 0V$		60		nA
Latch Propagation Delay	$t_{LPD}$	$V_S = 3V$		90		ns
Large Signal Voltage Gain	$A_{VO}$			110		dB
Output Swing Low	$V_{OL}$	$I_O = -500\mu A$		54	72	mV
		$I_O = -500\mu A$ , $-40^\circ C \leq T_A \leq +85^\circ C$			79	
		$I_O = -1mA$		106	140	
		$I_O = -1mA$ , $-40^\circ C \leq T_A \leq +85^\circ C$			154	
Output Current	$I_{OUT}$	Sink		-18	-15.5	mA
		Sink, $-40^\circ C \leq T_A \leq +85^\circ C$			-12.5	
Propagation Delay (High to Low)	$t_{PD}$	Overdrive = 10mV		12.7		$\mu s$
		Overdrive = 100mV		5.6		
Fall Time	$t_{FALL}$	Overdrive = 10mV, $C_L = 30pF$ , $R_L = 1M\Omega$		33		ns
		Overdrive = 100mV, $C_L = 30pF$ , $R_L = 1M\Omega$		30		
Noise of $V_{REF}$		$f = 0.1Hz$ to $10Hz$		0.32		$mV_{P-P}$
<b>VOLTAGE REFERENCE</b>						
Reference Voltage	$V_{REF}$	$I_{REF} = 0mA$	1.182	1.200	1.218	V
Reference Voltage Drift				41		$\mu V/^\circ C$
Reference Output Current (Source)				2		mA

## NOTE:

1. If the power supply ramp-up rate is lower than 5V/s, the reference voltage output is not guaranteed to start up.

TYPICAL PERFORMANCE CHARACTERISTICS

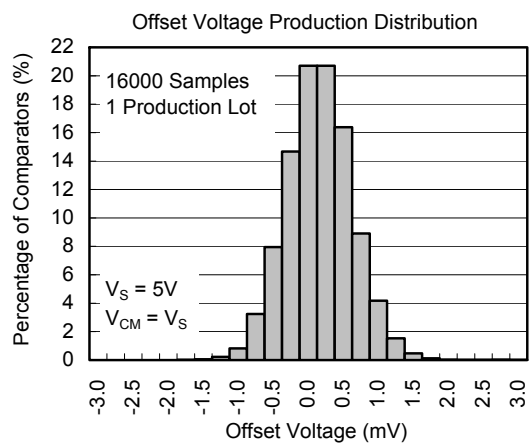
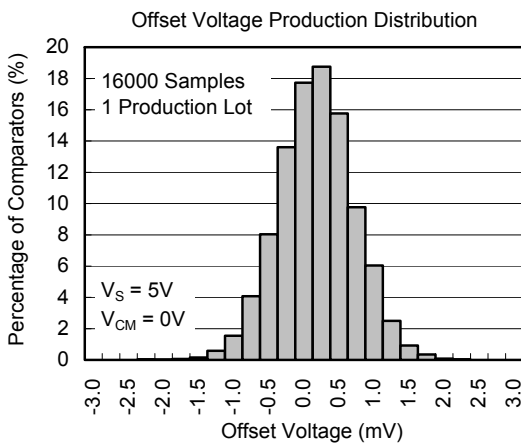
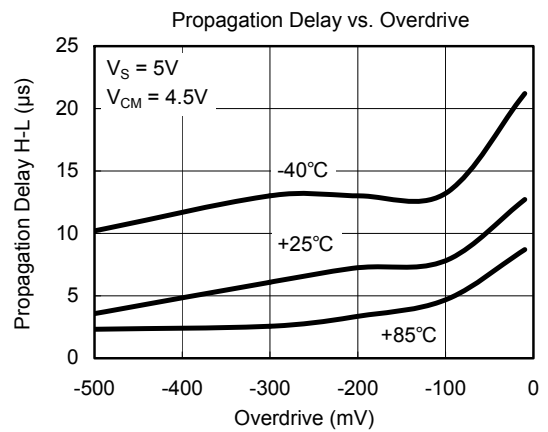
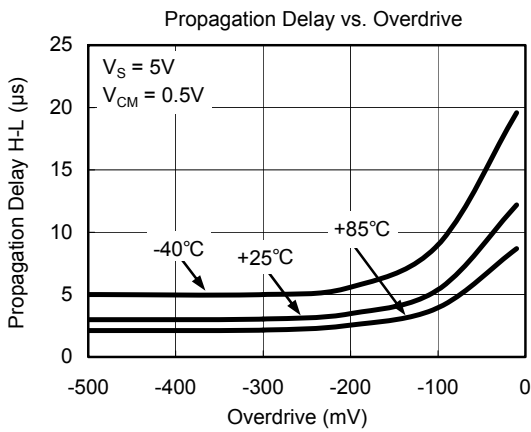
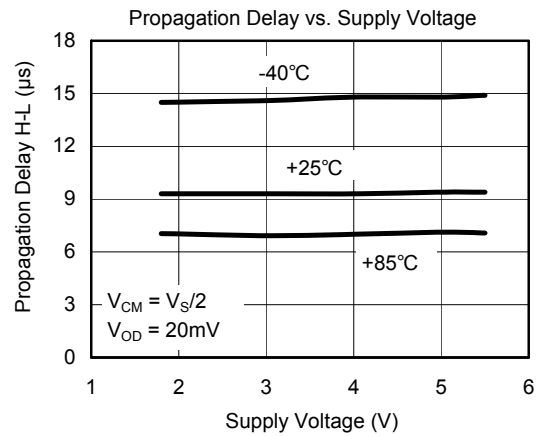
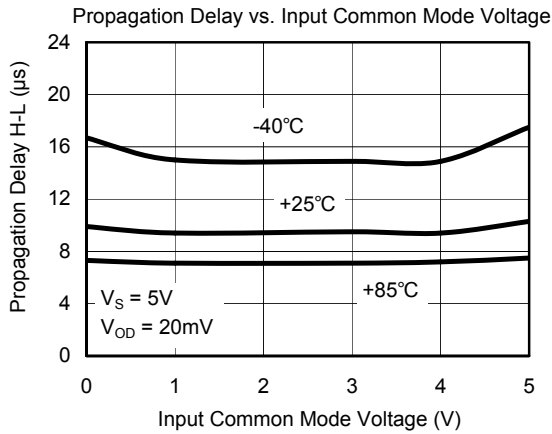

TYPICAL PERFORMANCE CHARACTERISTICS

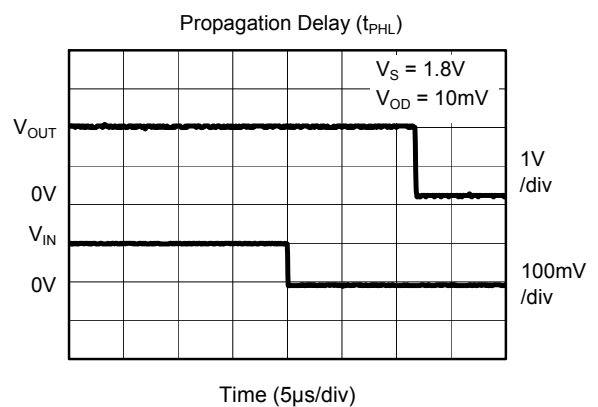
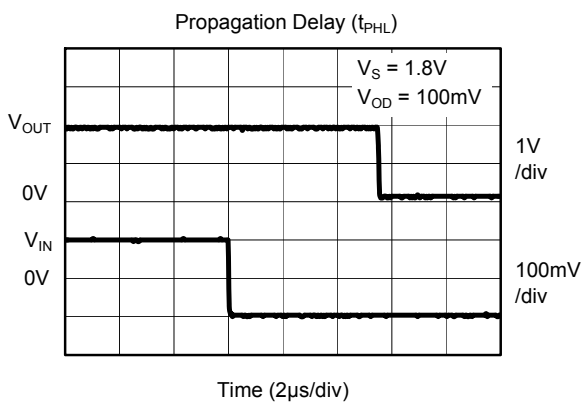
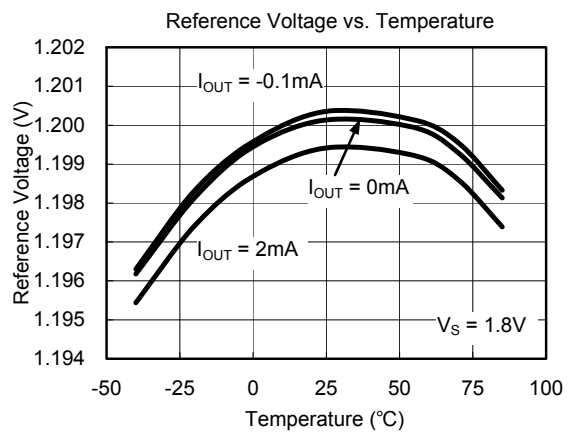
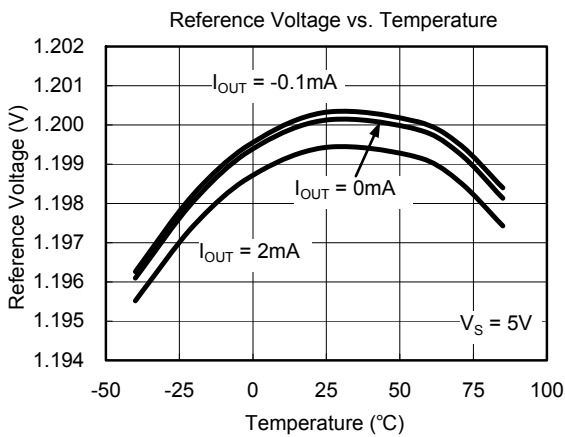
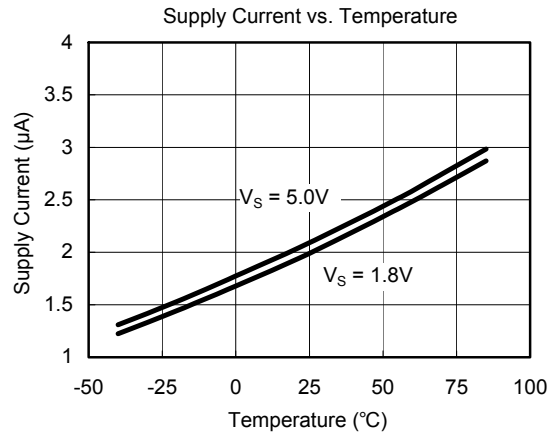
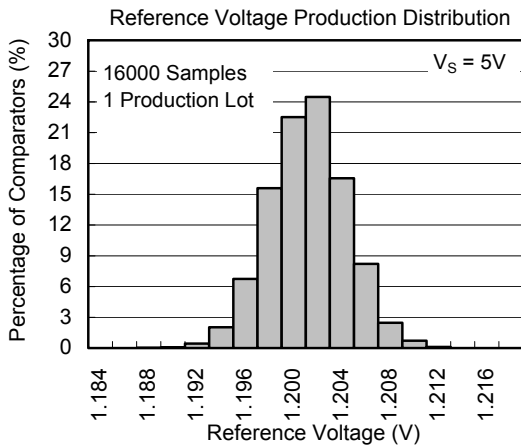

TYPICAL PERFORMANCE CHARACTERISTICS

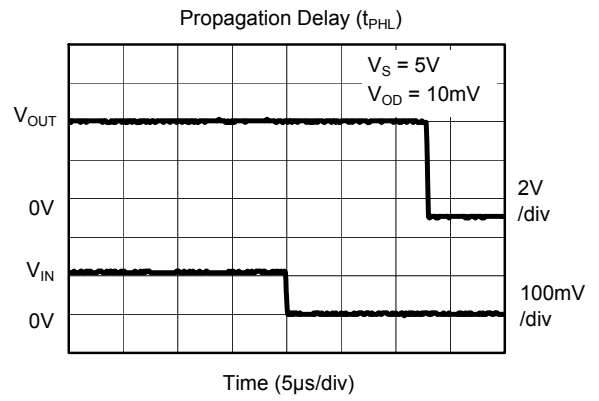
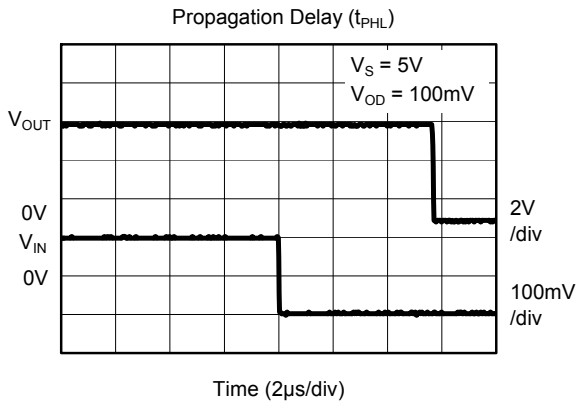

TIMING DIAGRAM

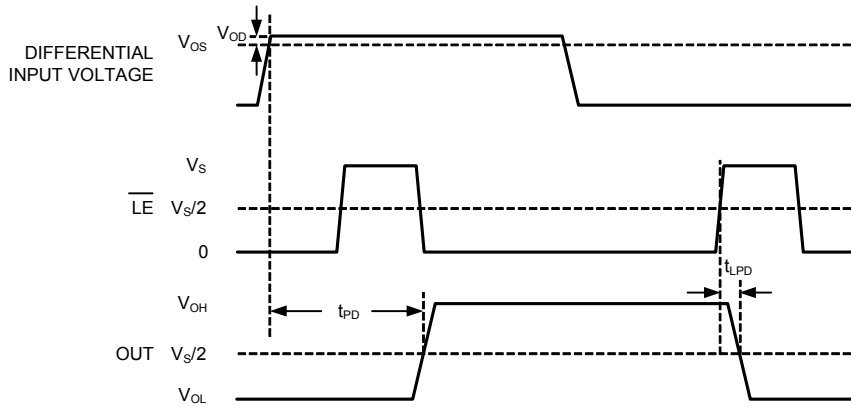
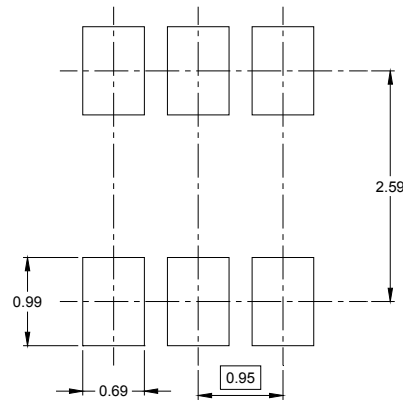
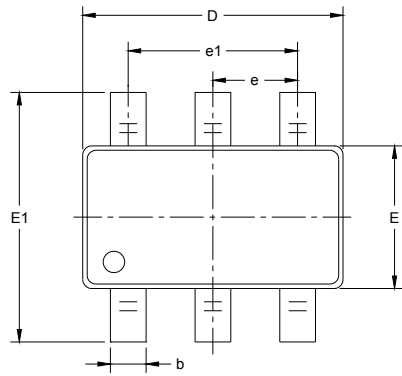

Figure 1. Timing Diagram with Latch Operator



PACKAGE OUTLINE DIMENSIONS

SOT-23-6



RECOMMENDED LAND PATTERN (Unit: mm)

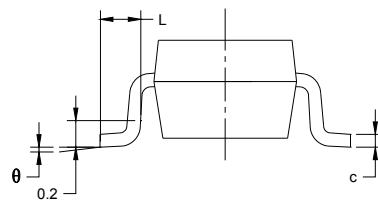
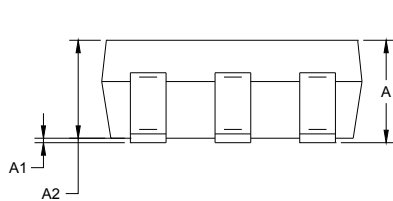

Symbol	Dimensions In Millimeters		Dimensions In Inches	
	MIN	MAX	MIN	MAX
A	1.050	1.250	0.041	0.049
A1	0.000	0.100	0.000	0.004
A2	1.050	1.150	0.041	0.045
b	0.300	0.500	0.012	0.020
c	0.100	0.200	0.004	0.008
D	2.820	3.020	0.111	0.119
E	1.500	1.700	0.059	0.067
E1	2.650	2.950	0.104	0.116
e	0.950 BSC		0.037 BSC	
e1	1.900 BSC		0.075 BSC	
L	0.300	0.600	0.012	0.024
$\theta$	0°	8°	0°	8°

PACKAGE OUTLINE DIMENSIONS

SOT-23-8

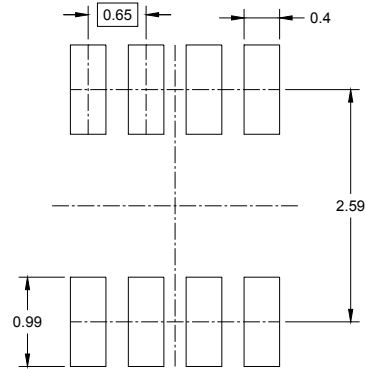
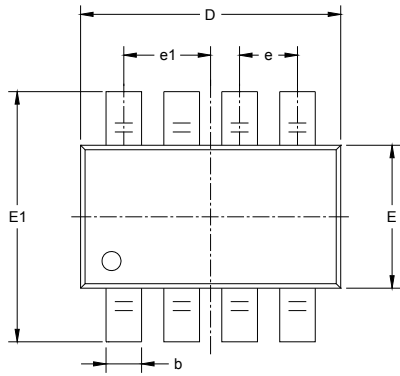

RECOMMENDED LAND PATTERN (Unit: mm)

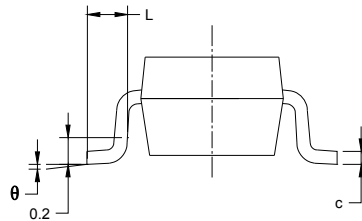
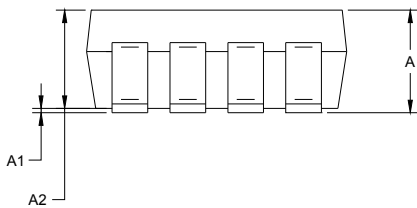

Symbol	Dimensions In Millimeters		Dimensions In Inches	
	MIN	MAX	MIN	MAX
A	1.050	1.250	0.041	0.049
A1	0.000	0.100	0.000	0.004
A2	1.050	1.150	0.041	0.045
b	0.300	0.500	0.012	0.020
c	0.100	0.200	0.004	0.008
D	2.820	3.020	0.111	0.119
E	1.500	1.700	0.059	0.067
E1	2.650	2.950	0.104	0.116
e	0.650 BSC		0.026 BSC	
e1	0.975 BSC		0.038 BSC	
L	0.300	0.600	0.012	0.024
$\theta$	0°	8°	0°	8°

**TAPE AND REEL INFORMATION**

**REEL DIMENSIONS**

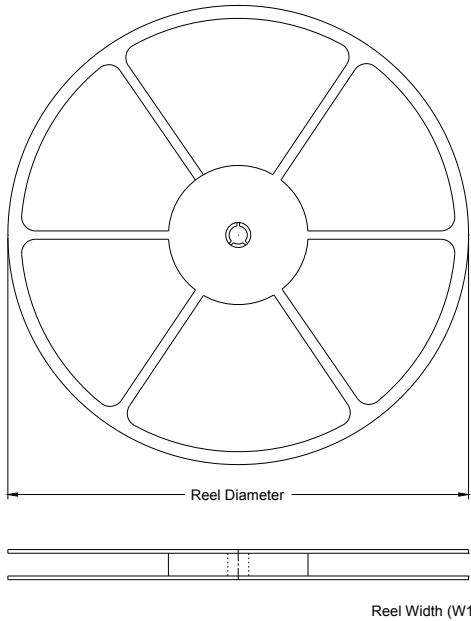

**TAPE DIMENSIONS**

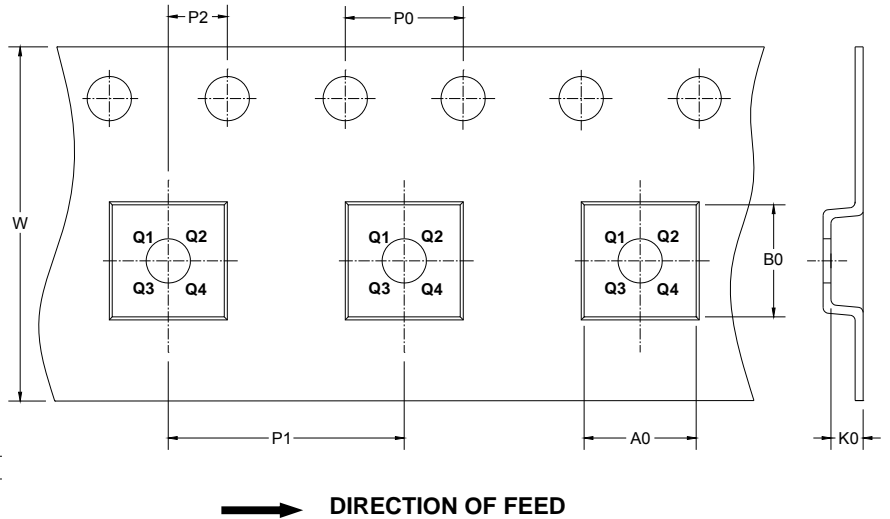

NOTE: The picture is only for reference. Please make the object as the standard.

**KEY PARAMETER LIST OF TAPE AND REEL**

Package Type	Reel Diameter	Reel Width W1 (mm)	A0 (mm)	B0 (mm)	K0 (mm)	P0 (mm)	P1 (mm)	P2 (mm)	W (mm)	Pin1 Quadrant
SOT-23-6	7"	9.5	3.17	3.23	1.37	4.0	4.0	2.0	8.0	Q3
SOT-23-8	7"	9.5	3.17	3.23	1.37	4.0	4.0	2.0	8.0	Q3

## SGM8710

## Micro-Power, RRIO, 1.8V, Open Drain Output Comparator with Integrated Voltage Reference

---

### CARTON BOX DIMENSIONS

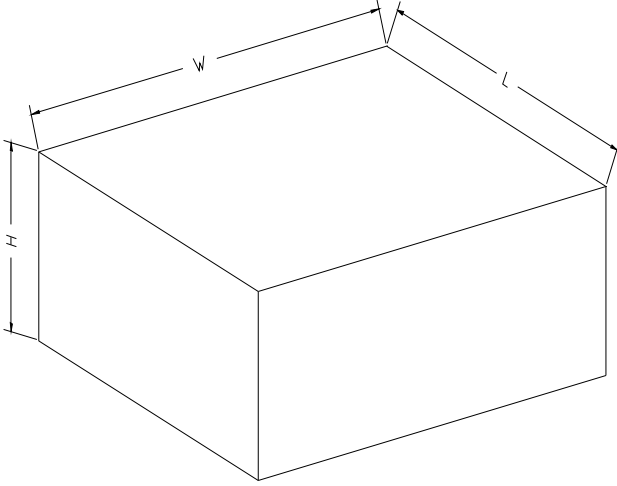

NOTE: The picture is only for reference. Please make the object as the standard.

### KEY PARAMETER LIST OF CARTON BOX

Reel Type	Length (mm)	Width (mm)	Height (mm)	Pizza/Carton
7" (Option)	368	227	224	8
7"	442	410	224	18

