



SGM7SZ14

Small Logic Inverter with Schmitt Trigger Input

GENERAL DESCRIPTION

The SGM7SZ14 is a single inverter with Schmitt trigger input from SGMICRO's Small Logic series. The device is fabricated with advanced CMOS technology to achieve ultra-high speed with high output drive while maintaining low static power dissipation over a broad V_{CC} operating range. The device is specified to operate over the 1.65V to 5.5V V_{CC} operating range. The input and output are high impedance when V_{CC} is 0V. The input tolerates voltages up to 6V, independent of V_{CC} operating voltage.

The SGM7SZ14 is available in Green SOT-23-5 and SC70-5 packages. It operates over an ambient temperature range of -40°C to +85°C.

FEATURES

- **Ultra-High Speed:** $t_{PD} = 4.2ns$ (TYP) into 50pF at $V_{CC} = 3.3V$
- **High Output Drive:** $\pm 24mA$ at $V_{CC} = 3V$
- **Broad V_{CC} Operating Range:** 1.65V to 5.5V
- **Matches Performance of LCX Operated at $V_{CC} = 3.3V$**
- **Power Down High-Impedance Input/Output**
- **Over-Voltage Tolerant Input Facilitates 5V to 3V Translation**
- **Available in Green SOT-23-5 and SC70-5 Packages**

LOGIC SYMBOL

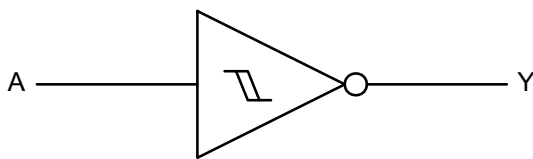

FUNCTION TABLE

INPUT	OUTPUT
A	Y
L	H
H	L

$Y = \bar{A}$
 H = HIGH Logic Level
 L = LOW Logic Level

PACKAGE/ORDERING INFORMATION

MODEL	PIN-PACKAGE	SPECIFIED TEMPERATURE RANGE	ORDERING NUMBER	PACKAGE MARKING	PACKAGE OPTION
SGM7SZ14	SC70-5	-40°C to +85°C	SGM7SZ14YC5G/TR	SF7XX	Tape and Reel, 3000
	SOT-23-5	-40°C to +85°C	SGM7SZ14YN5G/TR	SF8XX	Tape and Reel, 3000

NOTE: Order number and package marking are defined as the follow:

ORDER NUMBER

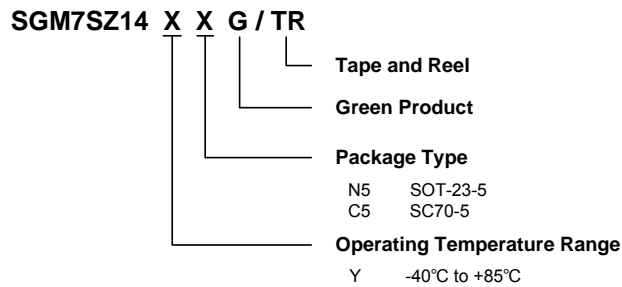

MARKING INFORMATION

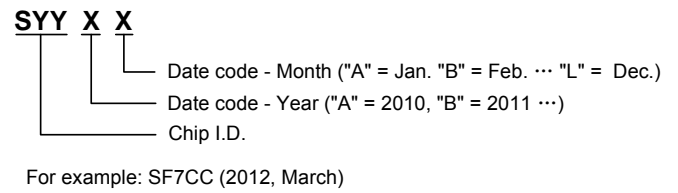

ABSOLUTE MAXIMUM RATINGS

Supply Voltage, V_{CC}	-0.5V to 6.0V
DC Input Voltage, V_{IN}	-0.5V to 6.0V
DC Output Voltage, V_{OUT}	-0.5V to 6.0V
DC Input Diode Current, I_{IK} ($V_{IN} < -0.5V$).....	-50mA
DC Output Diode Current, I_{OK} ($V_{OUT} < -0.5V$).....	-50mA
DC Output Current, I_{OUT}	$\pm 50mA$
DC V_{CC} or Ground Current, I_{CC} or I_{GND}	$\pm 50mA$
Operating Temperature Range.....	-40°C to +85°C
Junction Temperature.....	150°C
Storage Temperature.....	-65°C to +150°C
Lead Temperature (Soldering, 10sec).....	260°C

NOTE:

Stresses beyond those listed under "Absolute Maximum Ratings" may cause permanent damage to the device. These are stress ratings only, and functional operation of the device at these or any other conditions beyond those indicated in the operational sections of the specifications is not implied. Exposure to absolute maximum rating conditions for extended periods may affect device reliability.

CAUTION

This integrated circuit can be damaged by ESD if you don't pay attention to ESD protection. SGMICRO recommends that all integrated circuits be handled with appropriate precautions. Failure to observe proper handling and installation procedures can cause damage. ESD damage can range from subtle performance degradation to complete device failure. Precision integrated circuits may be more susceptible to damage because very small parametric changes could cause the device not to meet its published specifications.

SGMICRO reserves the right to make any change in circuit design, specification or other related things if necessary without notice at any time. Please contact SGMICRO sales office to get the latest datasheet.

PIN CONFIGURATIONS (TOP VIEW)

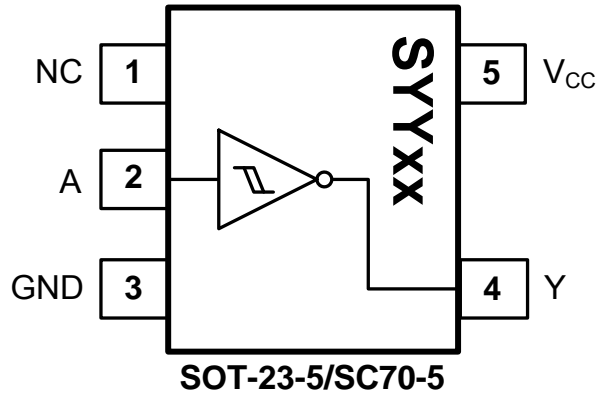

PIN DESCRIPTION

PIN	NAME	FUNCTION
1	NC	No Connection.
2	A	Input. Unused input must be held high or low. It may not float.
3	GND	Ground.
4	Y	Output.
5	V _{CC}	Power Supply.

ELECTRICAL CHARACTERISTICS

PARAMETER	SYMBOL	CONDITIONS	V _{CC} (V)	T _A = +25°C			UNITS			
				MIN	TYP	MAX				
GENERAL										
Power Supply Range	V _{CC}			1.65		5.50	V			
Supply Voltage Data Retention				1.50		5.50				
Input Voltage	V _{IN}			0.00		5.50	V			
Output Voltage	V _{OUT}			0.00		V _{CC}	V			
DC PERFORMANCE										
Positive Threshold Voltage	V _P			1.65		1.00	V			
				1.80		1.05				
				2.30		1.30				
				3.00		1.70				
				4.50		2.45				
Negative Threshold Voltage	V _N			1.65		0.55	V			
				1.80		0.60				
				2.30		0.75				
				3.00		1.05				
				4.50		1.55				
Hysteresis Voltage	V _H			1.65		0.45	V			
				1.80		0.50				
				2.30		0.55				
				3.00		0.65				
				4.50		0.90				
HIGH Level Output Voltage	V _{OH}	V _{IN} = V _{IL}	I _{OH} = -100μA			1.65		1.65	V	
						1.80		1.80		
						2.30		2.30		
						3.00		3.00		
						4.50		4.50		
					I _{OH} = -4mA		1.65			1.55
					I _{OH} = -8mA		2.30			2.18
					I _{OH} = -16mA		3.00			2.80
					I _{OH} = -24mA		3.00			2.70
					I _{OH} = -32mA		4.50			4.20
LOW Level Output Voltage	V _{OL}	V _{IN} = V _{IH}	I _{OL} = 100μA			1.65		0.00	V	
						1.80		0.00		
						2.30		0.00		
						3.00		0.00		
						4.50		0.00		
					I _{OL} = 4mA		1.65			0.07
					I _{OL} = 8mA		2.30			0.10
					I _{OL} = 16mA		3.00			0.17
					I _{OL} = 24mA		3.00			0.24
					I _{OL} = 32mA		4.50			0.28
Input Leakage Current	I _{IN}	V _{IN} = 5.5V, GND		0 to 5.5		±0.1	μA			
Power Off Leakage Current	I _{OFF}	V _{IN} or V _{OUT} = 5.5V		0		0.10	μA			
Quiescent Supply Current	I _{CC}	V _{IN} = 5.5V, GND		1.65 to 5.5		0.10	μA			

ELECTRICAL CHARACTERISTICS

PARAMETER	SYMBOL	CONDITIONS	T _A = +25°C			UNITS	
			MIN	TYP	MAX		
AC PERFORMANCE							
Propagation Delay	t _{PHL} , t _{PLH}	V _{CC} = 1.65V	C _L = 15pF, R _L = 1MΩ, Figure 1, Figure 2		9.3		ns
		V _{CC} = 1.80V			7.6		
		V _{CC} = 2.50V ± 0.20V			4.7		
		V _{CC} = 3.30V ± 0.30V			3.6		
		V _{CC} = 5.00V ± 0.50V			2.7		
		V _{CC} = 3.30V ± 0.30V		C _L = 50pF, R _L = 500Ω, Figure 1, Figure 2		4.2	
		V _{CC} = 5.00V ± 0.50V			3.2		
Input Capacitance	C _{IN}	V _{CC} = 0V		4.0		pF	
Power Dissipation Capacitance ⁽²⁾	C _{PD}	V _{CC} = 3.30V	Figure 3		17.0		pF
		V _{CC} = 5.00V			19.0		

NOTES:

- Unused inputs must be held HIGH or LOW. They may not float.
- C_{PD} is defined as the value of the internal equivalent capacitance which is derived from dynamic operating current consumption (I_{CCD}) at no output loading and operating at 50% duty cycle (see Figure 3). C_{PD} is related to dynamic operating current I_{CCD} by the expression: I_{CCD} = (C_{PD}) (V_{CC}) (f_{IN}) + (I_{CC,Static}).

TEST CIRCUITS

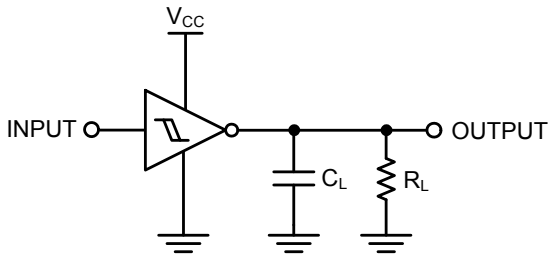

C_L includes load and stray capacitance;
Input PRR = 1.0MHz, t_w = 500ns.

Figure 1. AC Test Circuit

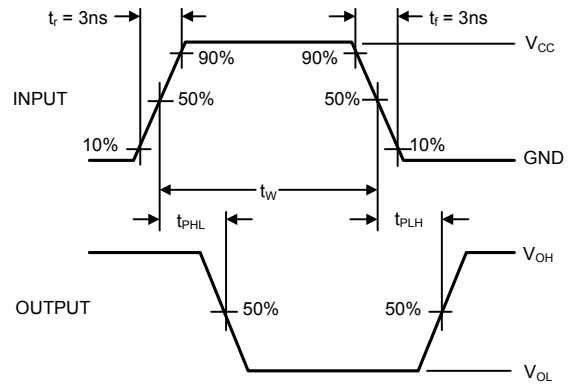
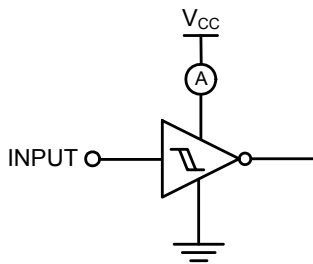

Figure 2. AC Waveforms



Input = AC Waveform; $t_r = t_f = 1.8$ ns;
PRR = 10MHz; Duty Cycle = 50%.

Figure 3. I_{CCD} Test Circuit

PACKAGE OUTLINE DIMENSIONS

SC70-5

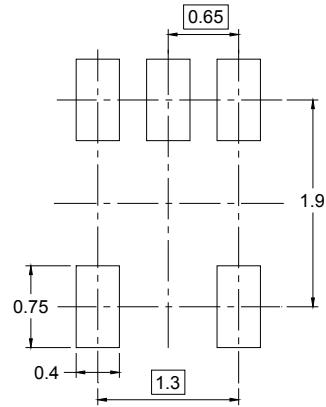
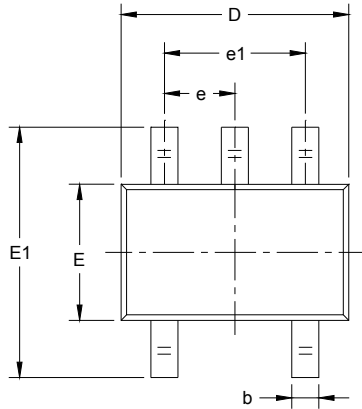

RECOMMENDED LAND PATTERN (Unit: mm)

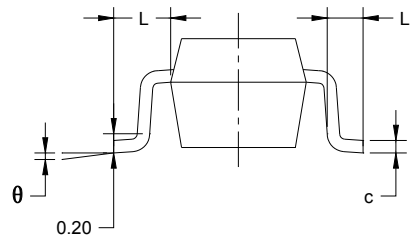
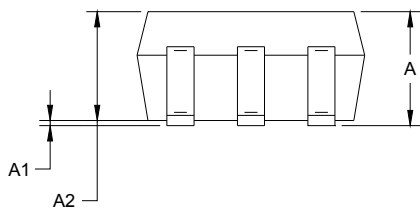

Symbol	Dimensions In Millimeters		Dimensions In Inches	
	MIN	MAX	MIN	MAX
A	0.900	1.100	0.035	0.043
A1	0.000	0.100	0.000	0.004
A2	0.900	1.000	0.035	0.039
b	0.150	0.350	0.006	0.014
c	0.080	0.150	0.003	0.006
D	2.000	2.200	0.079	0.087
E	1.150	1.350	0.045	0.053
E1	2.150	2.450	0.085	0.096
e	0.65 TYP		0.026 TYP	
e1	1.300 BSC		0.051 BSC	
L	0.525 REF		0.021 REF	
L1	0.260	0.460	0.010	0.018
θ	0°	8°	0°	8°

PACKAGE OUTLINE DIMENSIONS

SOT-23-5

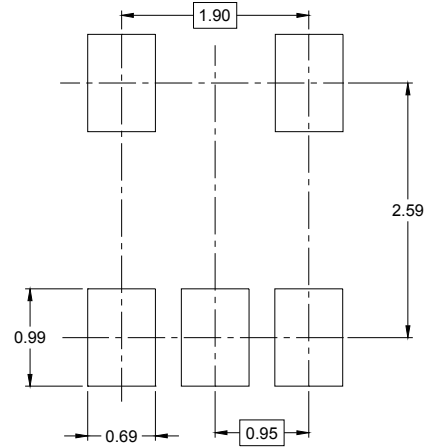
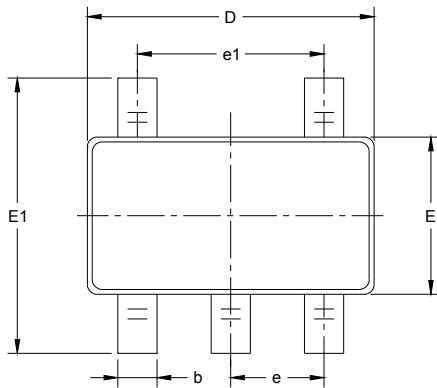

RECOMMENDED LAND PATTERN (Unit: mm)

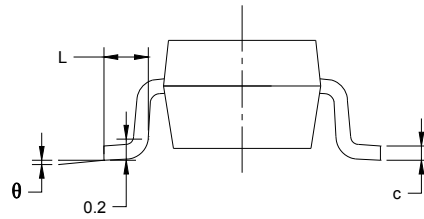
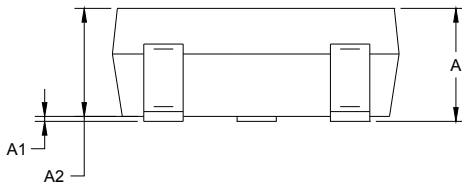

Symbol	Dimensions In Millimeters		Dimensions In Inches	
	MIN	MAX	MIN	MAX
A	1.050	1.250	0.041	0.049
A1	0.000	0.100	0.000	0.004
A2	1.050	1.150	0.041	0.045
b	0.300	0.500	0.012	0.020
c	0.100	0.200	0.004	0.008
D	2.820	3.020	0.111	0.119
E	1.500	1.700	0.059	0.067
E1	2.650	2.950	0.104	0.116
e	0.950 BSC		0.037 BSC	
e1	1.900 BSC		0.075 BSC	
L	0.300	0.600	0.012	0.024
θ	0°	8°	0°	8°