



SGM8418-1/SGM8418-2/SGM8418-4 24V, 3A Peak Output Current Rail-to-Rail I/O Operational Amplifiers

GENERAL DESCRIPTION

The SGM8418-1, SGM8418-2 and SGM8418-4 are low power, high slew rate, dual or single power supply, rail-to-rail input and output operational amplifiers.

The SGM8418-1 contains single amplifier, the SGM8418-2 contains dual amplifiers and SGM8418-4 contains quad amplifiers. The SGM8418-1/2/4 have a high slew rate (65V/ μ s), 3A peak output current and offset voltage below 10mV. The SGM8418-1/2/4 are ideal for Thin Film Transistors Liquid Crystal Displays (TFT LCD).

The single SGM8418-1 is available in a Green TDFN-3 \times 3-8L package. The dual SGM8418-2 is available in a Green MSOP-8 (Exposed Pad) package. The quad SGM8418-4 is available in a Green TSSOP-14 (Exposed Pad) package. They are specified over the -40°C to +85°C temperature range.

FEATURES

- Rail-to-Rail Output Swing
- Rail-to-Rail Input
- Supply Voltage Range: 4.5V to 26.5V
- Peak Output Current: 3A
- High Slew Rate: 65V/ μ s
- Unity-Gain Stable
- -40°C to +85°C Operating Temperature Range
- Small Packaging:
 - SGM8418-1 Available in a Green TDFN-3 \times 3-8L Package
 - SGM8418-2 Available in a Green MSOP-8 (Exposed Pad) Package
 - SGM8418-4 Available in a Green TSSOP-14 (Exposed Pad) Package

APPLICATIONS

TFT LCD Panels
Notebook Computers
Monitors
LCD TVs

PACKAGE/ORDERING INFORMATION

MODEL	PACKAGE DESCRIPTION	SPECIFIED TEMPERATURE RANGE	ORDERING NUMBER	PACKAGE MARKING	PACKING OPTION
SGM8418-1	TDFN-3×3-8L	-40°C to +85°C	SGM8418-1YTDB8G/TR	SGM G41DB XXXXX	Tape and Reel, 4000
SGM8418-2	MSOP-8 (Exposed Pad)	-40°C to +85°C	SGM8418-2YPMS8G/TR	SGM84182 YPMS8 XXXXX	Tape and Reel, 4000
SGM8418-4	TSSOP-14 (Exposed Pad)	-40°C to +85°C	SGM8418-4YPTS14G/TR	SGM84184 YPTS14 XXXXX	Tape and Reel, 4000

MARKING INFORMATION

NOTE: XXXXX = Date Code and Vendor Code.

XXXXX

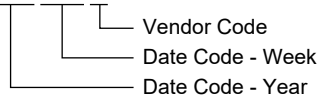

Green (RoHS & HSF): SG Micro Corp defines "Green" to mean Pb-Free (RoHS compatible) and free of halogen substances. If you have additional comments or questions, please contact your SGMICRO representative directly.

ABSOLUTE MAXIMUM RATINGS

Supply Voltage, (+V _S to -V _S)	-0.3V to 28V
Input/Output Voltage to -V _S	-0.3V to (+V _S) + 0.3V
+IN to -IN	±5V
Package Thermal Resistance	
TDFN-3×3-8L, θ _{JA}	84°C/W
MSOP-8 (Exposed Pad), θ _{JA}	82°C/W
TSSOP-14 (Exposed Pad), θ _{JA}	50°C/W
Junction Temperature	+150°C
Storage Temperature Range	-65°C to +150°C
Lead Temperature (Soldering, 10s)	+260°C
ESD Susceptibility	
HBM	8000V
MM	300V
CDM	1000V

RECOMMENDED OPERATING CONDITIONS

Supply Voltage Range	4.5V to 26.5V
Operating Temperature Range	-40°C to +85°C

OVERSTRESS CAUTION

Stresses beyond those listed in Absolute Maximum Ratings may cause permanent damage to the device. Exposure to absolute maximum rating conditions for extended periods may affect reliability. Functional operation of the device at any conditions beyond those indicated in the Recommended Operating Conditions section is not implied.

ESD SENSITIVITY CAUTION

This integrated circuit can be damaged if ESD protections are not considered carefully. SGMICRO recommends that all integrated circuits be handled with appropriate precautions. Failure to observe proper handling and installation procedures can cause damage. ESD damage can range from subtle performance degradation to complete device failure. Precision integrated circuits may be more susceptible to damage because even small parametric changes could cause the device not to meet the published specifications.

DISCLAIMER

SG Micro Corp reserves the right to make any change in circuit design, or specifications without prior notice.

PIN CONFIGURATIONS

FUNCTIONAL BLOCK DIAGRAMS

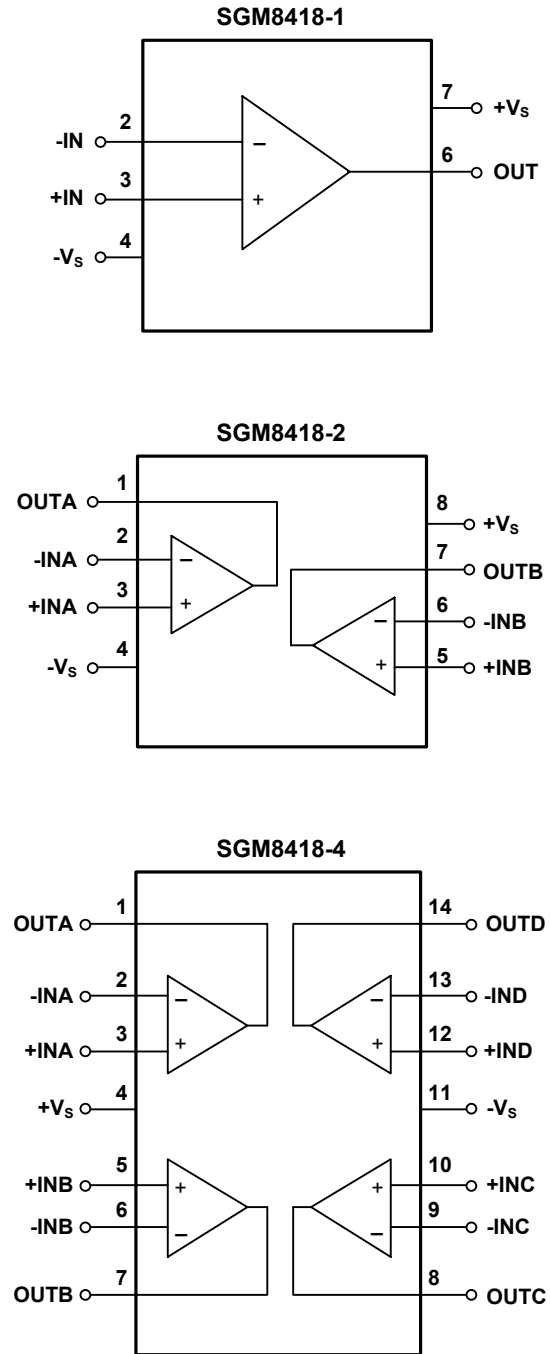
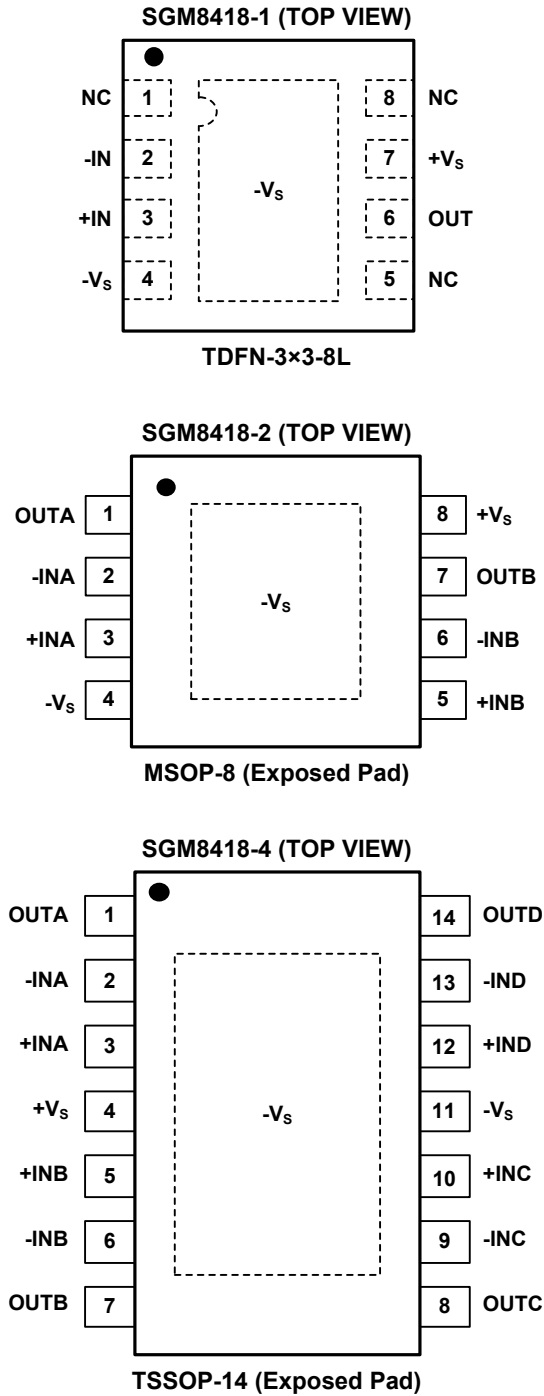

NOTE:
For all packages, connect thermal die pad to $-V_s$. Soldering the thermal pad improves heat dissipation and provides specified performance.

ELECTRICAL CHARACTERISTICS

($+V_S = 16V$, $-V_S = 0V$, $+V_{IN} = V_{OUT} = +V_S/2$, typical values are at $T_A = +25^\circ C$, unless otherwise specified.)

PARAMETER	SYMBOL	CONDITIONS	MIN	TYP	MAX	UNITS
Input Characteristics						
Input Offset Voltage	V_{OS}	$V_{CM} = +V_S/2$		2	10	mV
Input Offset Voltage Drift	$\Delta V_{OS}/\Delta T$	$V_{CM} = +V_S/2$		3.6		$\mu V/^\circ C$
Input Bias Current	I_B	$V_{CM} = +V_S/2$		1		nA
Load Regulation	ΔV_{LOAD}	$I_{OUT} = 0mA$ to $-80mA$		0.01		mV/mA
		$I_{OUT} = 0mA$ to $80mA$		-0.01		
Input Common Mode Voltage Range	V_{CM}		-0.1		$(+V_S) + 0.1$	V
Common Mode Rejection Ratio	CMRR	$-0.1V \leq V_{CM} \leq (+V_S) + 0.1V$		72		dB
Open-Loop Voltage Gain	A_{OL}	$0.5V \leq V_{OUT} \leq (+V_S) - 0.5V$		120		dB
Output Characteristics						
Low Output Voltage Swing from Rail	V_{OL}	$I_L = -50mA$		0.07	0.115	V
High Output Voltage Swing from Rail	V_{OH}	$I_L = 50mA$	$(+V_S) - 0.155$	$(+V_S) - 0.11$		V
Transient Peak Output Current	I_{PK}			± 3		A
Continuous Output Current	I_{OUT}			± 400		mA
Power Supply						
Supply Voltage Range			4.5		26.5	V
Power Supply Rejection Ratio	PSRR	$+V_S = 4.5V$ to $26.5V$, $V_{CM} = 3V$		94		dB
Quiescent Current/Amplifier	I_Q	No load		4.8		mA
Dynamic Performance						
Slew Rate	SR	4V step, $C_L = 50pF$, $R_L = 10k\Omega$, 20% to 80%, $A_V = 1$		65		V/ μs
Settling Time to $\pm 0.1\%$	t_s	$A_V = 1$, $V_{OUT} = 2V$ step, $R_L = 10k\Omega$, $C_L = 10pF$		140		ns
-3dB Bandwidth	BW	$R_L = 10k\Omega$, $C_L = 10pF$		75		MHz
Gain-Bandwidth Product	GBP	$R_L = 10k\Omega$, $C_L = 10pF$		28		MHz
Phase Margin		$R_L = 10k\Omega$, $C_L = 10pF$		33		$^\circ$
Noise Performance						
Input Voltage Noise Density	e_n	$f = 1kHz$		115		nV/\sqrt{Hz}
Thermal Protection						
Thermal Shutdown Temperature	T_{SHDN}			150		$^\circ C$
Thermal Shutdown Hysteresis	ΔT_{SHDN}			25		$^\circ C$

TYPICAL PERFORMANCE CHARACTERISTICS

At $T_A = +25^\circ\text{C}$, $+V_S = 16\text{V}$, $-V_S = 0\text{V}$, unless otherwise specified.

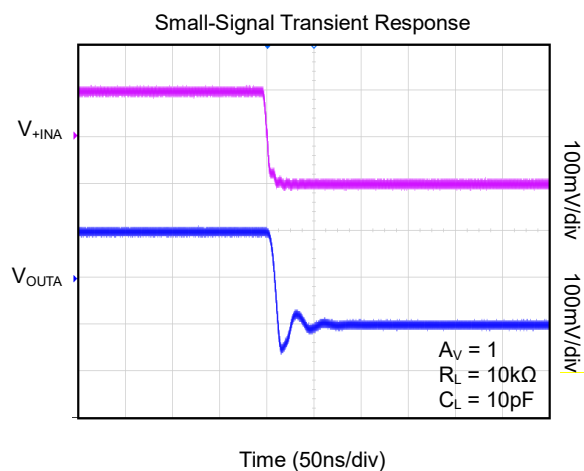
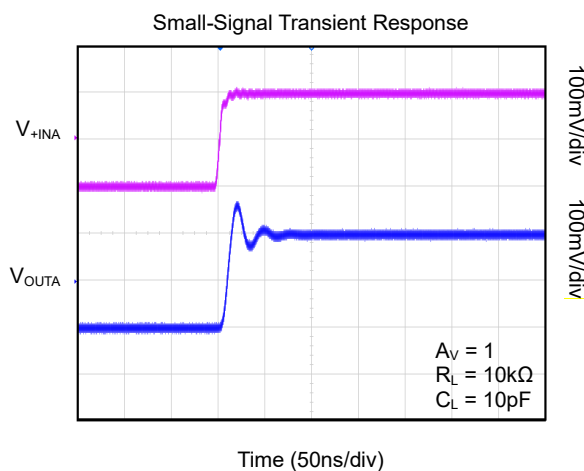
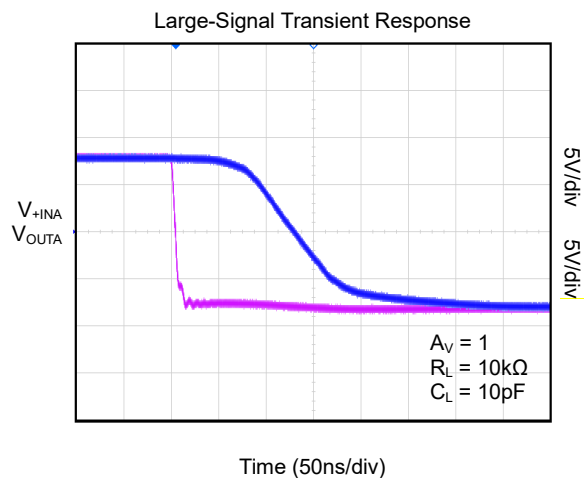
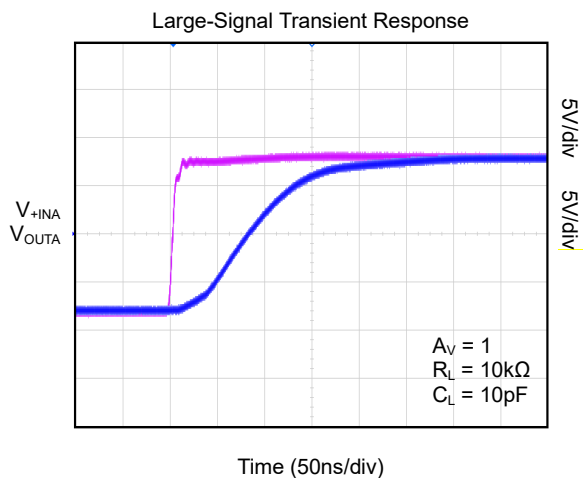

APPLICATION INFORMATION

The SGM8418-1/2/4 are high performance operational amplifiers capable of driving large loads for different applications. A high slew rate, rail-to-rail input and output capability, and low power consumption are the features which make the SGM8418-1/2/4 ideal for LCD applications.

Operating Voltage

The SGM8418-1/2/4 total supply voltage range is guaranteed from 4.5V to 26.5V. The specifications are stable over both the full supply range and operating temperatures from -40°C to +85°C. Decreasing the load current will obtain an output swing even closer to the supply rails.

LCD Panel Application

The SGM8418-1/2/4 are mainly designed for LCD V_{COM} buffer. The operational amplifiers have $\pm 3A$ instantaneous peak source/sink current.

Thermal Consideration

For continuous operation, do not exceed absolute maximum junction temperature. The maximum power dissipation depends on the thermal resistance of the IC package, PCB layout, rate of surrounding airflow, and difference between junction and ambient temperatures.

The maximum power dissipation can be calculated by the following formula:

$$P_{D(MAX)} = (T_{J(MAX)} - T_A)/\theta_{JA} \quad (1)$$

where $T_{J(MAX)}$ is the maximum junction temperature, T_A is the ambient temperature, and θ_{JA} is the junction to ambient thermal resistance.

For recommended operating condition specifications of the SGM8418-1/2/4, the maximum junction temperature is +150°C. The junction to ambient thermal resistance, θ_{JA} , is layout dependent.

The maximum power dissipation depends on the operating ambient temperature for fixed $T_{J(MAX)}$ and thermal resistance, θ_{JA} .

Layout Consideration

PCB layout is very important for designing high power circuits. The following layout guidelines should be strictly followed for best performance of the SGM8418-1/2/4.

1. Place the power components as close to the IC as possible. The traces should be wide and short, especially for the high current loop.
2. A series resistance may be needed at the output for some applications.
3. Proper supply bypassing ensures stability while driving high transient loads. For single-supply operation, bypass the power supply $+V_S$ to $-V_S$ with a 0.1 μF ceramic capacitor which should be placed close to the $+V_S$ pin. For dual-supply operation, both the $+V_S$ and the $-V_S$ supplies should be bypassed to ground with separate 0.1 μF ceramic capacitors. A 10 μF tantalum capacitor in parallel can be beneficial when delivering high transient output current.
4. Connect a 0.1 μF capacitor from +IN to ground and place it as close to the IC as possible for better performance.
5. The exposed pad of the chip must be connected to $-V_S$ plane for maximum thermal consideration.

REVISION HISTORY

NOTE: Page numbers for previous revisions may differ from page numbers in the current version.

JULY 2020 – REV.A to REV.A.1	Page
Updated TSSOP-14 (Exposed Pad) package	9
Updated Tape and Reel Information section	10

Changes from Original (MAY 2016) to REV.A	Page
Changed from product preview to production data	All

PACKAGE OUTLINE DIMENSIONS

TDFN-3x3-8L

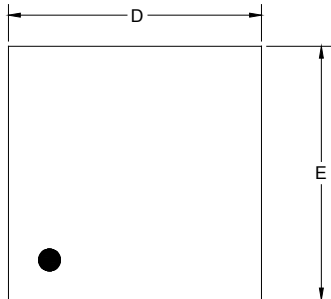

TOP VIEW

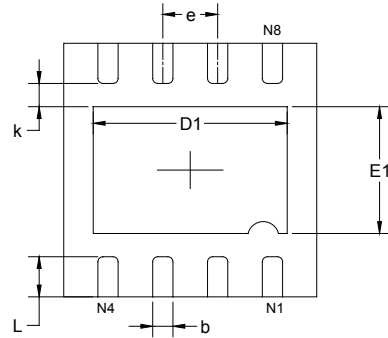

BOTTOM VIEW

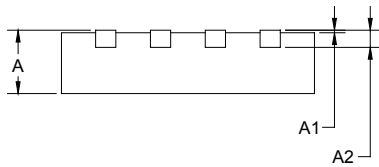

SIDE VIEW

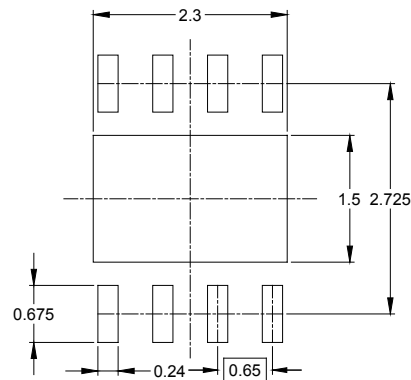

RECOMMENDED LAND PATTERN (Unit: mm)

Symbol	Dimensions In Millimeters		Dimensions In Inches	
	MIN	MAX	MIN	MAX
A	0.700	0.800	0.028	0.031
A1	0.000	0.050	0.000	0.002
A2	0.203 REF		0.008 REF	
D	2.900	3.100	0.114	0.122
D1	2.200	2.400	0.087	0.094
E	2.900	3.100	0.114	0.122
E1	1.400	1.600	0.055	0.063
k	0.200 MIN		0.008 MIN	
b	0.180	0.300	0.007	0.012
e	0.650 TYP		0.026 TYP	
L	0.375	0.575	0.015	0.023

PACKAGE OUTLINE DIMENSIONS

MSOP-8 (Exposed Pad)

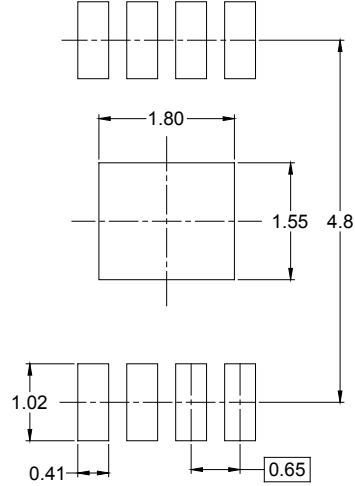
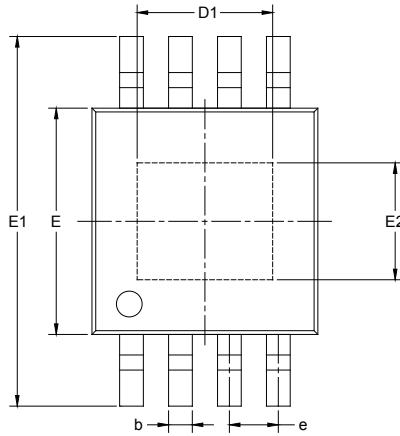

RECOMMENDED LAND PATTERN (Unit: mm)

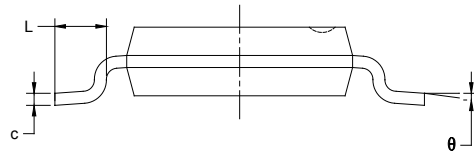
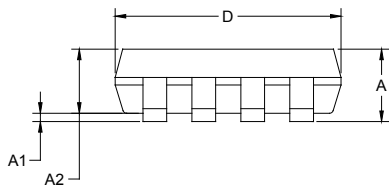

Symbol	Dimensions In Millimeters		Dimensions In Inches	
	MIN	MAX	MIN	MAX
A	0.820	1.100	0.032	0.043
A1	0.020	0.150	0.001	0.006
A2	0.750	0.950	0.030	0.037
b	0.250	0.380	0.010	0.015
c	0.090	0.230	0.004	0.009
D	2.900	3.100	0.114	0.122
D1	1.700	1.900	0.067	0.075
e	0.65 BSC		0.026 BSC	
E	2.900	3.100	0.114	0.122
E1	4.750	5.050	0.187	0.199
E2	1.450	1.650	0.057	0.065
L	0.400	0.800	0.016	0.031
θ	0°	6°	0°	6°

PACKAGE OUTLINE DIMENSIONS

TSSOP-14 (Exposed Pad)

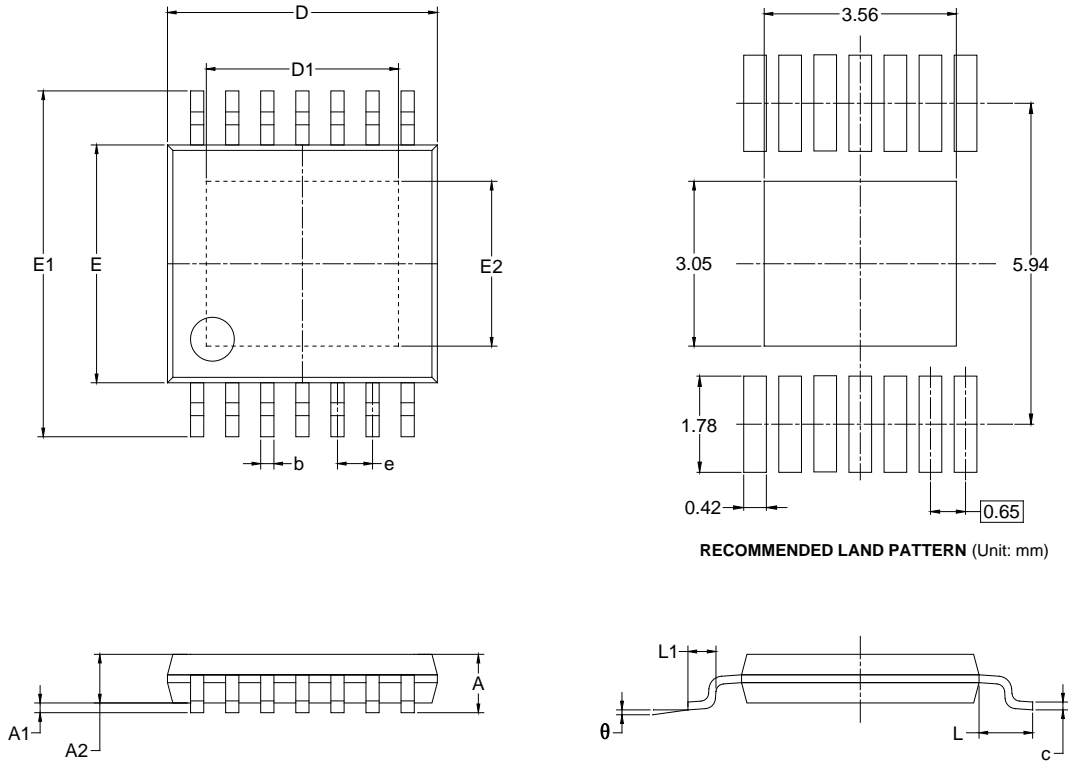

Symbol	Dimensions In Millimeters		Dimensions In Inches	
	MIN	MAX	MIN	MAX
A		1.200		0.047
A1	0.050	0.150	0.002	0.006
A2	0.800	1.050	0.031	0.041
b	0.190	0.300	0.007	0.012
c	0.090	0.200	0.004	0.008
D	4.900	5.100	0.193	0.201
D1	3.460	3.660	0.136	0.144
E	4.300	4.500	0.169	0.177
E1	6.250	6.550	0.246	0.258
E2	2.950	3.150	0.116	0.124
e	0.650 BSC		0.026 BSC	
L		1.000		0.039
L1	0.450	0.750	0.018	0.030
θ	0°	8°	0°	8°

PACKAGE INFORMATION

TAPE AND REEL INFORMATION

REEL DIMENSIONS



TAPE DIMENSIONS



NOTE: The picture is only for reference. Please make the object as the standard.

KEY PARAMETER LIST OF TAPE AND REEL

Package Type	Reel Diameter	Reel Width W1 (mm)	A0 (mm)	B0 (mm)	K0 (mm)	P0 (mm)	P1 (mm)	P2 (mm)	W (mm)	Pin1 Quadrant
TDFN-3×3-8L	13"	12.4	3.35	3.35	1.13	4.0	8.0	2.0	12.0	Q1
MSOP-8 (Exposed Pad)	13"	12.4	5.20	3.30	1.50	4.0	8.0	2.0	12.0	Q1
TSSOP-14 (Exposed Pad)	13"	16.4	6.80	5.40	1.30	4.0	8.0	2.0	16.0	Q1

DD0001

PACKAGE INFORMATION

CARTON BOX DIMENSIONS



NOTE: The picture is only for reference. Please make the object as the standard.

KEY PARAMETER LIST OF CARTON BOX

Reel Type	Length (mm)	Width (mm)	Height (mm)	Pizza/Carton
13"	386	280	370	5

DD0002