



# BGU8009

SiGe:C low-noise amplifier MMIC for GPS, GLONASS, Galileo and COMPASS and LTE B32

Rev. 7 — 20 July 2017

Product data sheet

## 1 General description

The BGU8009 is, also known as the GPS1201M, a Low-Noise Amplifier (LNA) for GNSS receiver and LTE Band 32 down link applications, available in a small plastic 6-pin extremely thin leadless package. The BGU8009 requires one external matching inductor and one external decoupling capacitor.

The BGU8009 adapts itself to the changing environment resulting from co-habitation of different radio systems in modern cellular handsets. It has been designed for low power consumption and optimal performance when jamming signals from co-existing cellular transmitters are present. At low jamming power levels, it delivers 18 dB gain at a noise figure of 0.65 dB. During high jamming power levels, resulting for example from a cellular transmit burst, it temporarily increases its bias current to improve sensitivity.

## 2 Features and benefits

- Covers full GNSS L1 band, from 1559 MHz to 1610 MHz and LTE band 32 from 1452 MHz to 1496 MHz
- GNSS:
  - Noise figure = 0.65 dB
  - Gain 18 dB
  - High input 1 dB compression point of -7 dBm
  - High out of band IP<sub>3i</sub> of 6 dBm
- LTE B32:
  - Noise figure = 0.65 dB
  - Gain 20 dB
  - High input 1 dB compression point of -8.5 dBm
- Supply voltage 1.5 V to 3.1 V
- Optimized performance at low supply current of 4.2 mA
- Power-down mode current consumption < 1  $\mu$ A
- Integrated temperature stabilized bias for easy design
- Requires only one input matching inductor and one supply decoupling capacitor
- Input and output DC decoupled
- ESD protection on all pins (HBM > 2 kV)
- Integrated matching for the output
- Available in a 6-pins leadless package 1.1 mm  $\times$  0.9 mm  $\times$  0.47 mm; 0.4 mm pitch: SOT1230
- 180 GHz transit frequency - SiGe:C technology
- Moisture sensitivity level 1



### 3 Applications

- Smart phones
- Feature phones
- Tablets
- Digital still cameras
- Digital video cameras
- RF front-end modules
- Complete GNSS modules
- Personal health applications

### 4 Quick reference data

**Table 1. Quick reference data GNSS band L1**

$f = 1575 \text{ MHz}$ ;  $V_{CC} = 2.85 \text{ V}$ ;  $P_i < -40 \text{ dBm}$ ;  $T_{amb} = 25 \text{ }^\circ\text{C}$ ; input matched to  $50 \text{ } \Omega$  using a  $5.6 \text{ nH}$  inductor, see [Figure 34](#), unless otherwise specified.

Symbol	Parameter	Conditions	Min	Typ	Max	Unit
$V_{CC}$	supply voltage		1.5	-	3.1	V
$I_{CC}$	supply current	$V_{I(ENABLE)} \geq 0.8 \text{ V}$				
		• $P_i < -40 \text{ dBm}$	2.6	4.4	6.5	mA
		• $P_i = -20 \text{ dBm}$	-	9	-	mA
$G_p$	power gain	$P_i < -40 \text{ dBm}$	16	17.8	20	dB
		$P_i = -20 \text{ dBm}$	-	20.0	-	dB
NF	noise figure	$P_i < -40 \text{ dBm}$ [1]	-	0.65	1.2	dB
		$P_i < -40 \text{ dBm}$ [1]	-	0.70	1.25	dB
$P_{i(1dB)}$	input power at 1 dB gain compression	$V_{CC} = 1.8 \text{ V}$	-	-10	-	dBm
		$V_{CC} = 2.85 \text{ V}$	-12.5	-7	-	dBm
IP3 <sub>i</sub>	input third-order intercept point	$V_{CC} = 1.8 \text{ V}$ [2]	-	3	-	dBm
		$V_{CC} = 2.85 \text{ V}$ [2]	-	6	-	dBm

[1] PCB losses are subtracted.

[2]  $f_1 = 1713 \text{ MHz}$ ;  $f_2 = 1851 \text{ MHz}$ ;  $P_i = -20 \text{ dBm}$  per carrier.

**Table 2. Quick reference data LTE B32**

$f = 1474 \text{ MHz}$ ;  $V_{CC} = 2.8 \text{ V}$ ;  $P_i = -30 \text{ dBm}$ ;  $T_{amb} = 25 \text{ }^\circ\text{C}$ ; input matched to  $50 \text{ } \Omega$  using a  $9.1 \text{ nH}$  inductor, see [Figure 34](#), unless otherwise specified.

Symbol	Parameter	Conditions	Min	Typ	Max	Unit
$V_{CC}$	supply voltage		1.5	-	3.1	V
$I_{CC}$	supply current	$V_{I(ENABLE)} \geq 0.8 \text{ V}$		4.4		mA
$G_p$	power gain			20		dB
NF	noise figure	[1]	-	0.65		dB
$P_{i(1dB)}$	input power at 1 dB gain compression	$V_{CC} = 1.8 \text{ V}$	-	-11	-	dBm

Symbol	Parameter	Conditions	Min	Typ	Max	Unit
		$V_{CC} = 2.8\text{ V}$		-8.5	-	dBm
IP3 <sub>i</sub>	input third-order intercept point	$V_{CC} = 1.8\text{ V}$ [2]	-	-7	-	dBm
		$V_{CC} = 2.8\text{ V}$ [2]	-	-6	-	dBm

[1] PCB losses are subtracted.  
 [2]  $\Delta f = 1\text{ MHz}$ ;  $P_1 = -30\text{ dBm}$  per carrier.

## 5 Ordering information

Table 3. Ordering information

Type number	Package		Version
	Name	Description	
BGU8009	XSON6	plastic very thin small outline package; no leads; 6 terminals; body 1.1 × 0.9 × 0.47 mm	SOT1230
OM7820	EVB	BGU8009 evaluation board, MMIC only	-
OM7824	EVB	BGU8009 evaluation board, front-end EVB	-
OM17066	EVB	BGU8009 evaluation board for LTE B32	

## 6 Marking

Table 4. Marking codes

Type number	Marking code
BGU8009	A

### 6.1 Marking code description

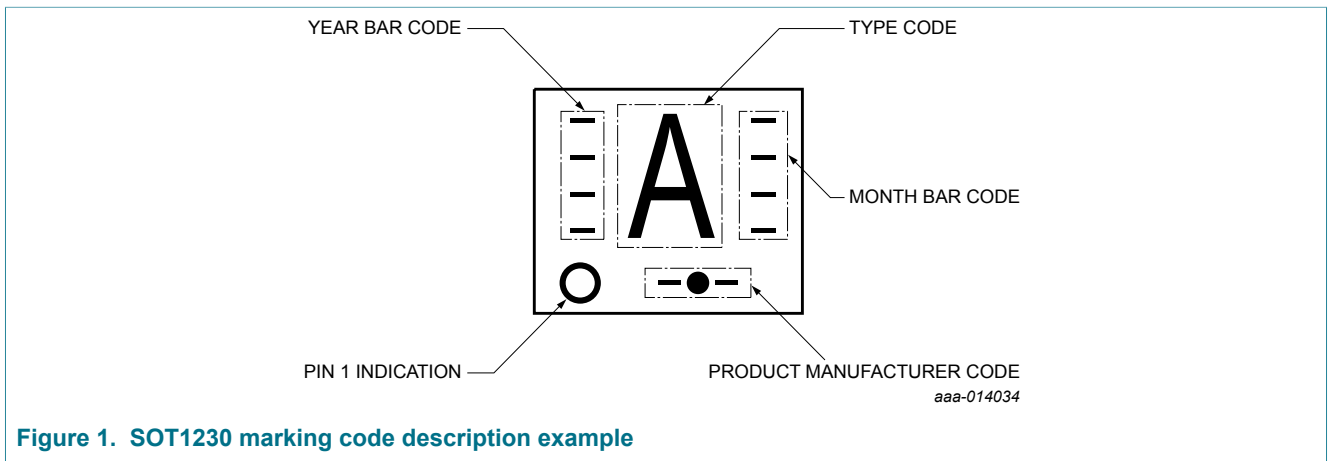
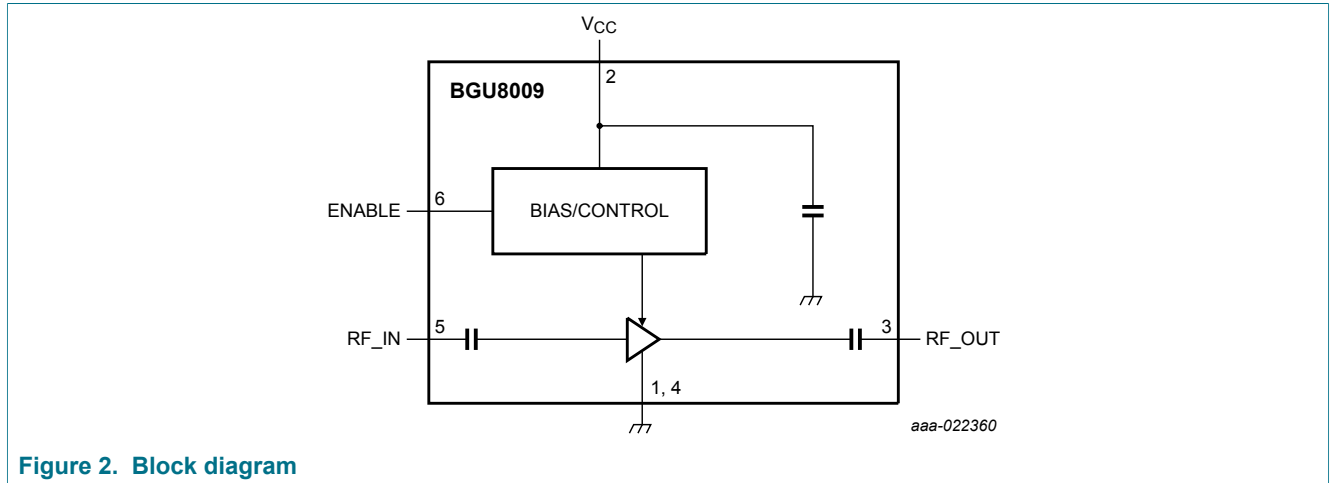

Figure 1. SOT1230 marking code description example

## 7 Block diagram



## 8 Pinning information

### 8.1 Pinning

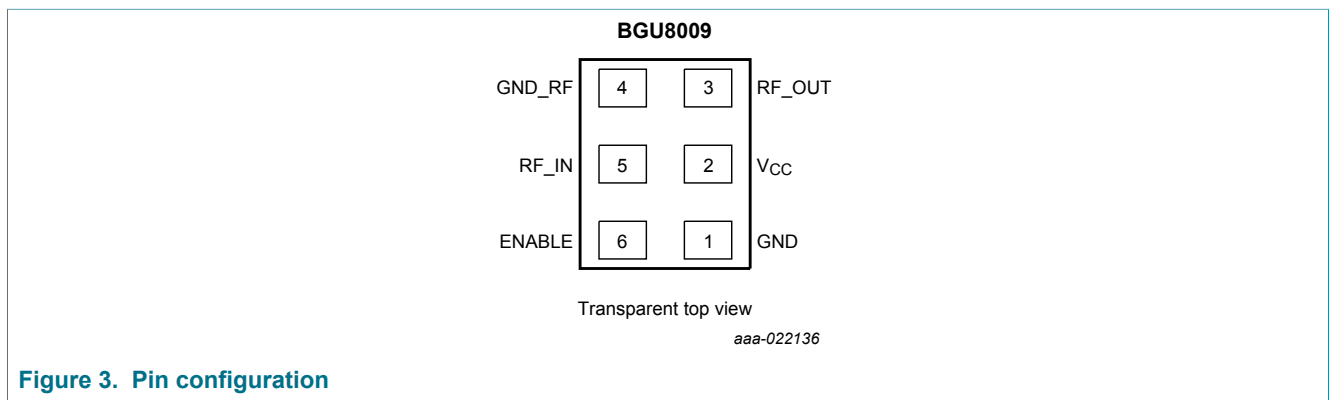

### 8.2 Pin description

Table 5. Pin description

Symbol	Pin	Description
GND	1	ground
V <sub>CC</sub>	2	supply voltage
RF_OUT	3	RF output
GND_RF	4	RF ground
RF_IN	5	RF input
ENABLE	6	enable

## 9 Limiting values

**Table 6. Limiting values**

In accordance with the Absolute Maximum Rating System (IEC 60134). Absolute Maximum Ratings are given as Limiting Values of stress conditions during operation, that must not be exceeded under the worst probable conditions.

Symbol	Parameter	Conditions	Min	Max	Unit
V <sub>CC</sub>	supply voltage	[1]	-0.5	+5.0	V
V <sub>I(ENABLE)</sub>	input voltage on pin ENABLE	V <sub>I(ENABLE)</sub> < V <sub>CC</sub> + 0.6 V [1] [2]	-0.5	+5.0	V
V <sub>I(RF_IN)</sub>	input voltage on pin RF_IN	DC, V <sub>I(RF_IN)</sub> < V <sub>CC</sub> + 0.6 V [1] [2] [3]	-0.5	+5.0	V
V <sub>I(RF_OUT)</sub>	input voltage on pin RF_OUT	DC, V <sub>I(RF_OUT)</sub> < V <sub>CC</sub> + 0.6 V [1] [2] [3]	-0.5	+5.0	V
P <sub>i</sub>	input power	1575 MHz [1]	-	10	dBm
		1474 MHz [1]	-	10	dBm
P <sub>tot</sub>	total power dissipation	T <sub>sp</sub> ≤ 130 °C	-	55	mW
T <sub>stg</sub>	storage temperature		-65	+150	°C
T <sub>j</sub>	junction temperature		-	150	°C
V <sub>ESD</sub>	electrostatic discharge voltage	Human Body Model (HBM) according to JEDEC standard JS-001-2010	-	±2	kV
		Charged Device Model (CDM) according to JEDEC standard JESD22-C101C	-	±1	kV

[1] Stressed with pulses of 200 ms in duration, with application circuit as in [Figure 34](#).

[2] Warning: due to internal ESD diode protection, the applied DC voltage shall not exceed V<sub>CC</sub> + 0.6 V and shall not exceed 5.0 V to avoid excess current.

[3] The RF input and RF output are AC coupled through internal DC blocking capacitors.

## 10 Recommended operating conditions

**Table 7. Operating conditions**

Symbol	Parameter	Conditions	Min	Typ	Max	Unit
V <sub>CC</sub>	supply voltage		1.5	-	3.1	V
T <sub>amb</sub>	ambient temperature		-40	+25	+85	°C
V <sub>I(ENABLE)</sub>	input voltage on pin ENABLE	OFF state	-	-	0.3	V
		ON state	0.8	-	-	V

## 11 Thermal characteristics

**Table 8. Thermal characteristics**

Symbol	Parameter	Conditions	Typ	Unit
R <sub>th(j-sp)</sub>	thermal resistance from junction to solder point		225	K/W

## 12 Characteristics GNSS band L1

**Table 9. Characteristics at  $V_{CC} = 1.8\text{ V}$**

$f = 1575\text{ MHz}$ ;  $V_{CC} = 1.8\text{ V}$ ;  $V_{I(ENABLE)} \geq 0.8\text{ V}$ ;  $P_i < -40\text{ dBm}$ ;  $T_{amb} = 25\text{ }^\circ\text{C}$ ; input matched to  $50\ \Omega$  using a  $5.6\text{ nH}$  inductor, see [Figure 34](#), unless otherwise specified.

Symbol	Parameter	Conditions	Min	Typ	Max	Unit
$I_{CC}$	supply current	$V_{I(ENABLE)} \geq 0.8\text{ V}$				
		$P_i < -40\text{ dBm}$	2.3	4.2	6.2	mA
		$P_i = -20\text{ dBm}$	-	9	-	mA
		$V_{I(ENABLE)} \leq 0.3\text{ V}$	-	-	1	$\mu\text{A}$
$G_p$	power gain	no jammer	16	17.6	20	dB
		$P_{jam} = -20\text{ dBm}$ ; $f_{jam} = 850\text{ MHz}$	-	19.8	-	dB
		$P_{jam} = -20\text{ dBm}$ ; $f_{jam} = 1850\text{ MHz}$	-	20.0	-	dB
$RL_{in}$	input return loss	$P_i < -40\text{ dBm}$	-	9	-	dB
		$P_i = -20\text{ dBm}$	-	11	-	dB
$RL_{out}$	output return loss	$P_i < -40\text{ dBm}$	-	15	-	dB
		$P_i = -20\text{ dBm}$	-	15	-	dB
ISL	isolation		-	37	-	dB
NF	noise figure	$P_i = -40\text{ dBm}$ ; no jammer <sup>[1]</sup>	-	0.65	1.2	dB
		$P_i = -40\text{ dBm}$ ; no jammer <sup>[2] [1]</sup>	-	0.70	1.25	dB
		$P_{jam} = -20\text{ dBm}$ ; $f_{jam} = 850\text{ MHz}$ <sup>[2]</sup>	-	0.9	-	dB
		$P_{jam} = -20\text{ dBm}$ ; $f_{jam} = 1850\text{ MHz}$ <sup>[2]</sup>	-	1.2	-	dB
$P_{i(1dB)}$	input power at 1 dB gain compression		<sup>[1]</sup>	-10	-	dBm
$IP3_i$	input third-order intercept point		<sup>[1] [3]</sup>	3	-	dBm
			<sup>[1] [4]</sup>	3	-	dBm
$t_{on}$	turn-on time	time from $V_{I(ENABLE)}$ ON to 90 % of the gain	-	-	2	$\mu\text{s}$
$t_{off}$	turn-off time	time from $V_{I(ENABLE)}$ OFF to 10 % of the gain	-	-	1	$\mu\text{s}$

[1] Guaranteed by device design; not tested in production.  
 [2] Including PCB losses.  
 [3]  $f_1 = 1713\text{ MHz}$ ;  $f_2 = 1851\text{ MHz}$ ,  $P_i = -20\text{ dBm}$  per carrier.  
 [4]  $f_1 = 1713\text{ MHz}$ ;  $f_2 = 1851\text{ MHz}$ ,  $P_{i(1)} = -20\text{ dBm}$ ,  $P_{i(2)} = -65\text{ dBm}$ .

**Table 10. Characteristics at Vcc = 2.85 V**

$f = 1575 \text{ MHz}$ ;  $V_{CC} = 2.85 \text{ V}$ ;  $V_{I(ENABLE)} \geq 0.8 \text{ V}$ ;  $P_i < -40 \text{ dBm}$ ;  $T_{amb} = 25 \text{ }^\circ\text{C}$ ; input matched to  $50 \text{ } \Omega$  using a  $5.6 \text{ nH}$  inductor, see [Figure 34](#), unless otherwise specified.

Symbol	Parameter	Conditions	Min	Typ	Max	Unit
I <sub>CC</sub>	supply current	$V_{I(ENABLE)} \geq 0.8 \text{ V}$				
		• $P_i < -40 \text{ dBm}$	2.6	4.4	6.5	mA
		• $P_i = -20 \text{ dBm}$	-	9	-	mA
		$V_{I(ENABLE)} \leq 0.3 \text{ V}$	-	-	1	$\mu\text{A}$
G <sub>p</sub>	power gain	no jammer	16	17.8	20	dB
		• $P_{jam} = -20 \text{ dBm}$ ; $f_{jam} = 850 \text{ MHz}$	-	20.0	-	dB
		• $P_{jam} = -20 \text{ dBm}$ ; $f_{jam} = 1850 \text{ MHz}$	-	20.2	-	dB
RL <sub>in</sub>	input return loss	$P_i < -40 \text{ dBm}$	-	9	-	dB
		$P_i = -20 \text{ dBm}$	-	11	-	dB
RL <sub>out</sub>	output return loss	$P_i < -40 \text{ dBm}$	-	15	-	dB
		$P_i = -20 \text{ dBm}$	-	15	-	dB
ISL	isolation		-	37	-	dB
NF	noise figure	$P_i = -40 \text{ dBm}$ ; no jammer <sup>[1]</sup>	-	0.65	1.2	dB
		$P_i = -40 \text{ dBm}$ ; no jammer <sup>[2] [1]</sup>	-	0.70	1.25	dB
		$P_{jam} = -20 \text{ dBm}$ ; $f_{jam} = 850 \text{ MHz}$ <sup>[2]</sup>	-	0.9	-	dB
		$P_{jam} = -20 \text{ dBm}$ ; $f_{jam} = 1850 \text{ MHz}$ <sup>[2]</sup>	-	1.2	-	dB
P <sub>I(1dB)</sub>	input power at 1 dB gain compression		<sup>[1]</sup> -12.5	-7	-	dBm
IP3 <sub>i</sub>	input third-order intercept point	<sup>[1] [3]</sup>	0	6	-	dBm
		<sup>[1] [4]</sup>	0	6	-	dBm
t <sub>on</sub>	turn-on time	time from $V_{I(ENABLE)}$ ON to 90 % of the gain	-	-	2	$\mu\text{s}$
t <sub>off</sub>	turn-off time	time from $V_{I(ENABLE)}$ OFF to 10 % of the gain	-	-	1	$\mu\text{s}$

[1] Guaranteed by device design; not tested in production.  
 [2] Including PCB losses.  
 [3]  $f_1 = 1713 \text{ MHz}$ ;  $f_2 = 1851 \text{ MHz}$ ,  $P_i = -20 \text{ dBm}$  per carrier.  
 [4]  $f_1 = 1713 \text{ MHz}$ ;  $f_2 = 1851 \text{ MHz}$ ,  $P_{i(1)} = -20 \text{ dBm}$ ,  $P_{i(2)} = -65 \text{ dBm}$ .

13 Graphs GNSS band L1

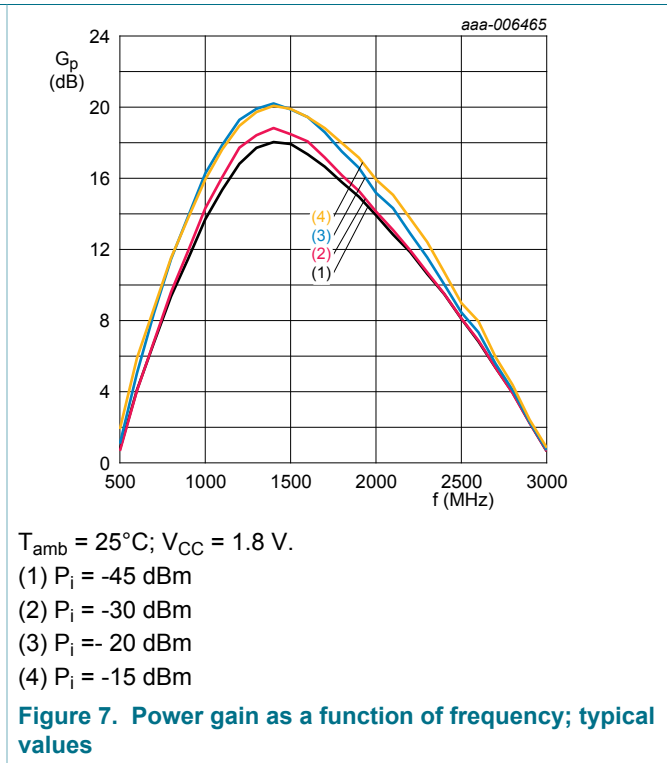
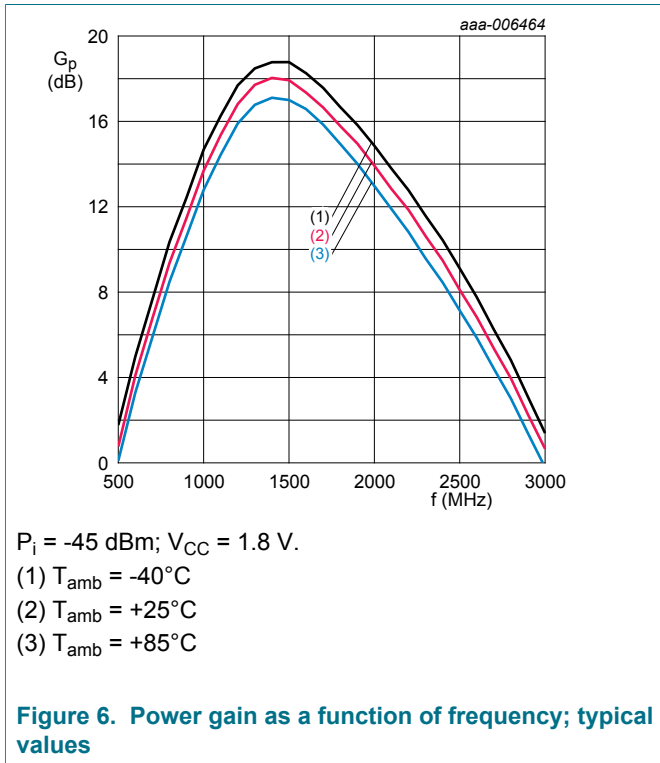
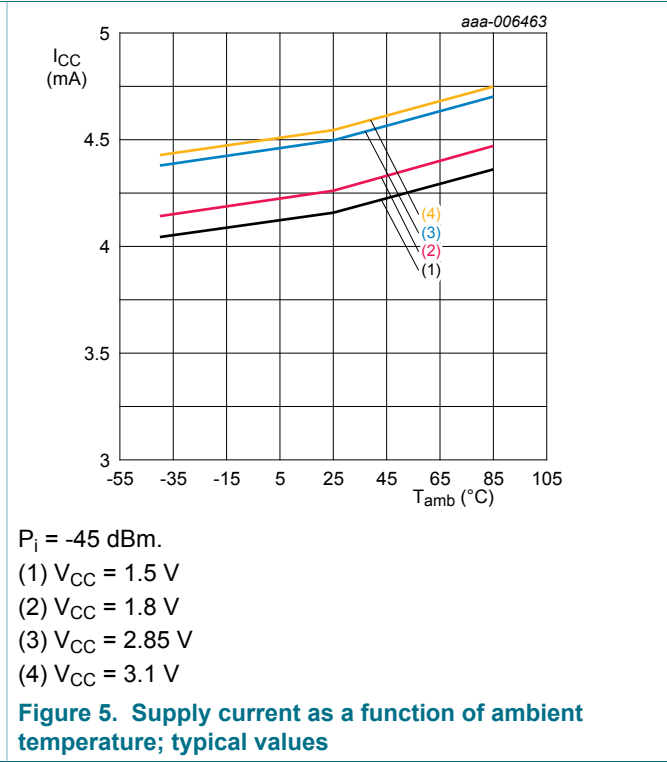
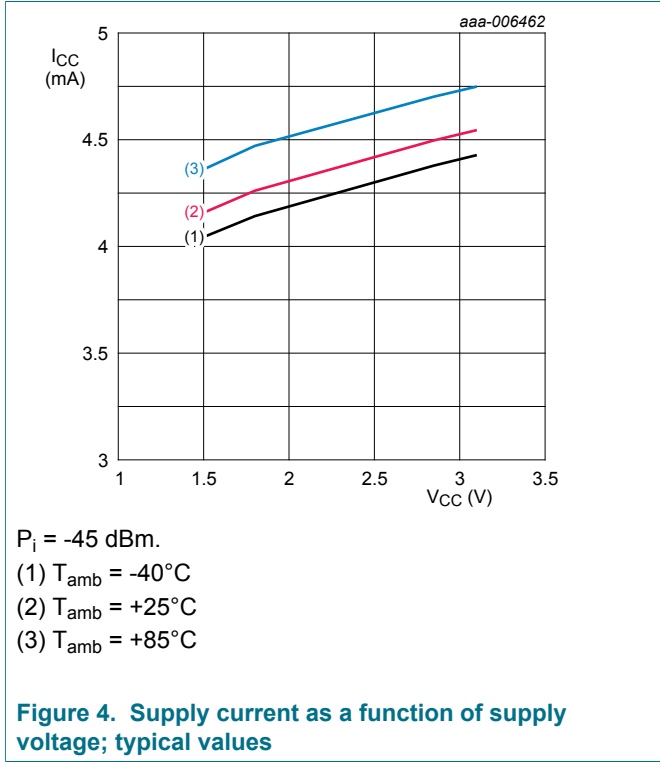



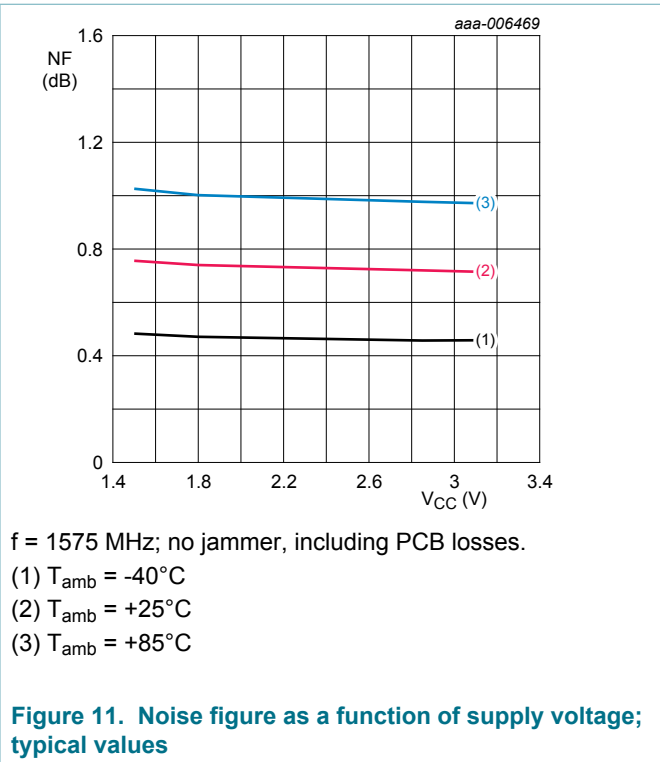
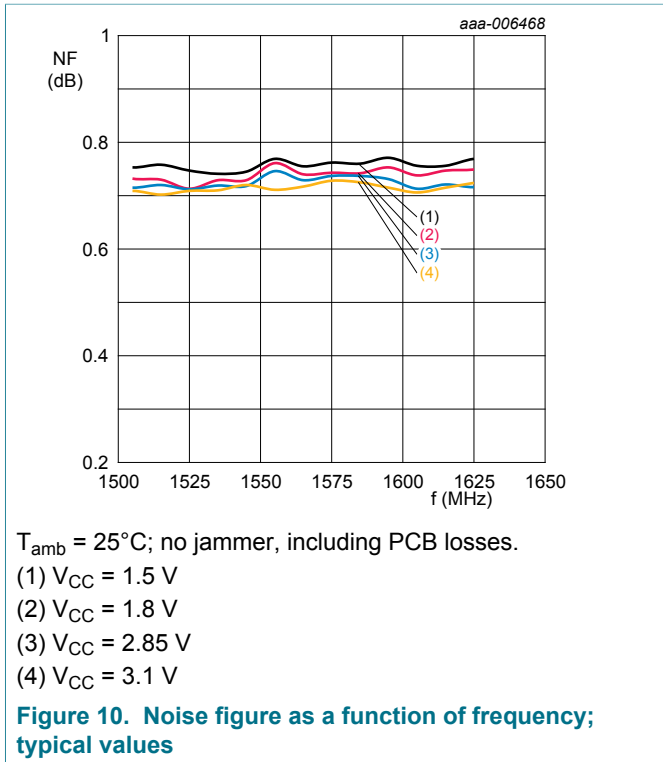
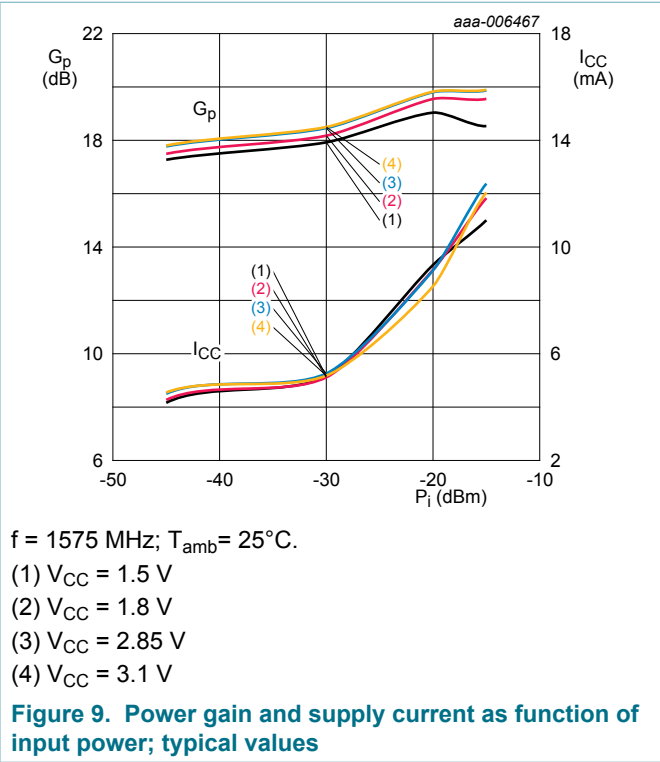
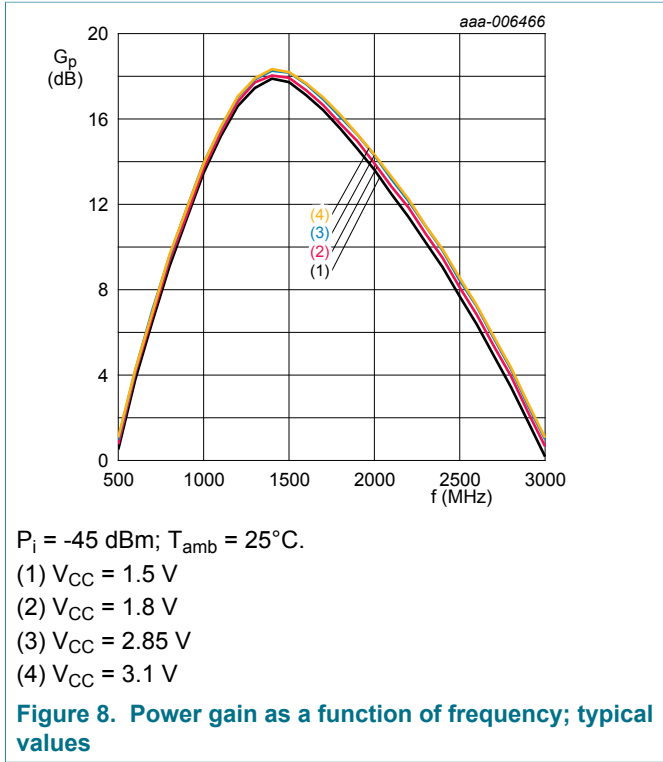

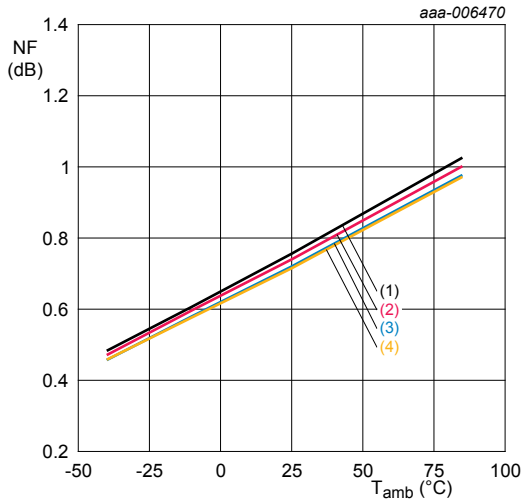

$f = 1575 \text{ MHz}$ ; no jammer, including PCB losses.

- (1)  $V_{CC} = 1.5 \text{ V}$
- (2)  $V_{CC} = 1.8 \text{ V}$
- (3)  $V_{CC} = 2.85 \text{ V}$
- (4)  $V_{CC} = 3.1 \text{ V}$

**Figure 12. Noise figure as a function of ambient temperature; typical values**

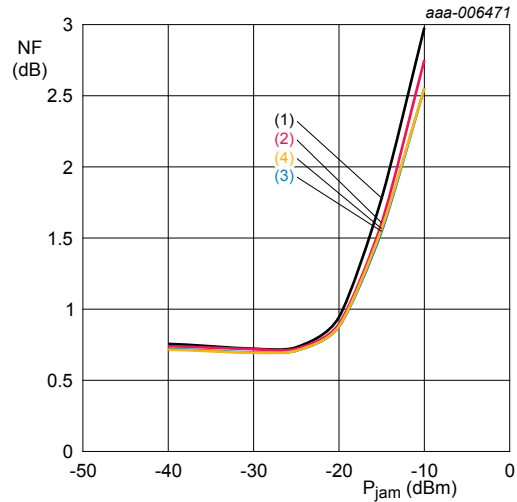

$f_{jam} = 850 \text{ MHz}$ ;  $T_{amb} = 25^\circ\text{C}$ ;  $f = 1575 \text{ MHz}$ ; including PCB losses.

- (1)  $V_{CC} = 1.5 \text{ V}$
- (2)  $V_{CC} = 1.8 \text{ V}$
- (3)  $V_{CC} = 2.85 \text{ V}$
- (4)  $V_{CC} = 3.1 \text{ V}$

**Figure 13. Noise figure as a function of jamming power; typical values**

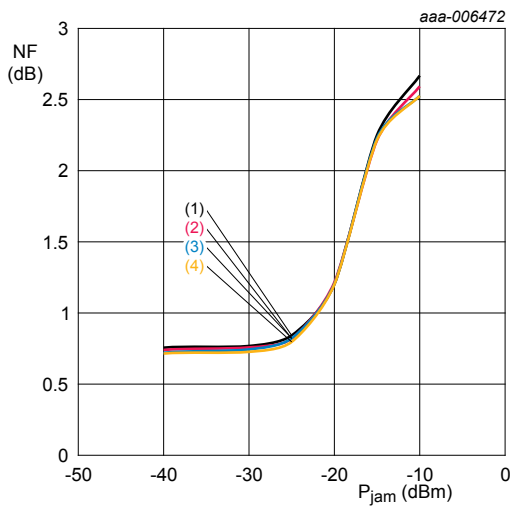

$f_{jam} = 1850 \text{ MHz}$ ;  $T_{amb} = 25^\circ\text{C}$ ;  $f = 1575 \text{ MHz}$ ; including PCB losses.

- (1)  $V_{CC} = 1.5 \text{ V}$
- (2)  $V_{CC} = 1.8 \text{ V}$
- (3)  $V_{CC} = 2.85 \text{ V}$
- (4)  $V_{CC} = 3.1 \text{ V}$

**Figure 14. Noise figure as a function of jamming power; typical values**

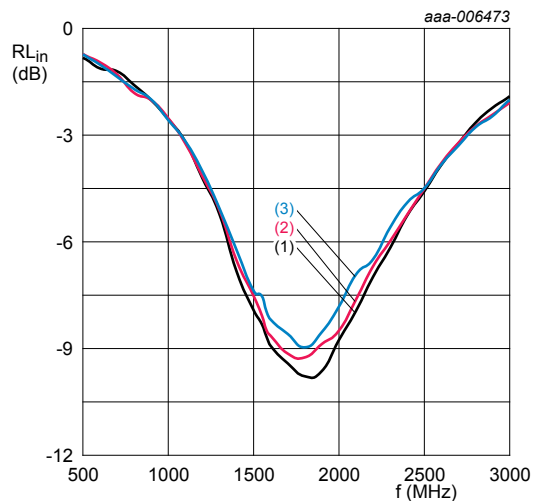

$P_i = -45 \text{ dBm}$ ;  $V_{CC} = 1.8 \text{ V}$ .

- (1)  $T_{amb} = -40^\circ\text{C}$
- (2)  $T_{amb} = +25^\circ\text{C}$
- (3)  $T_{amb} = +85^\circ\text{C}$

**Figure 15. Input return loss as a function of frequency; typical values**

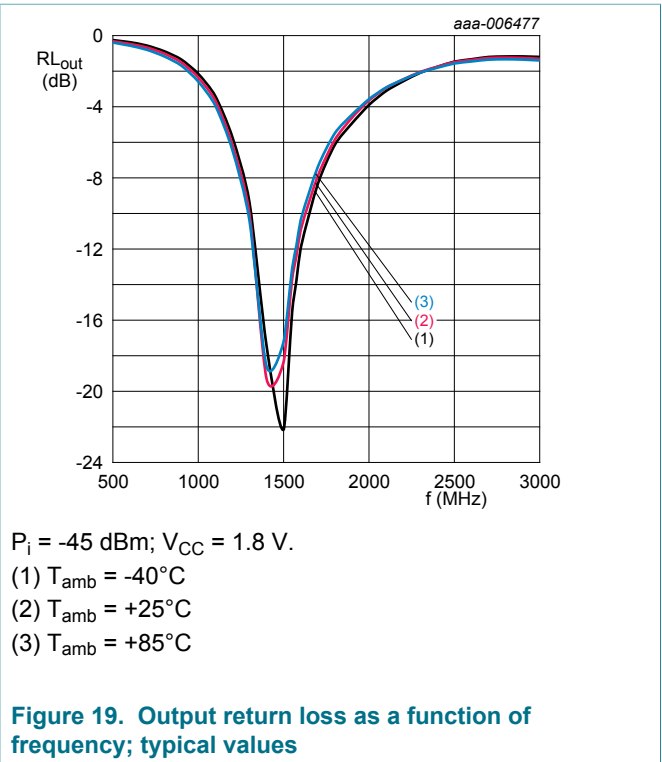
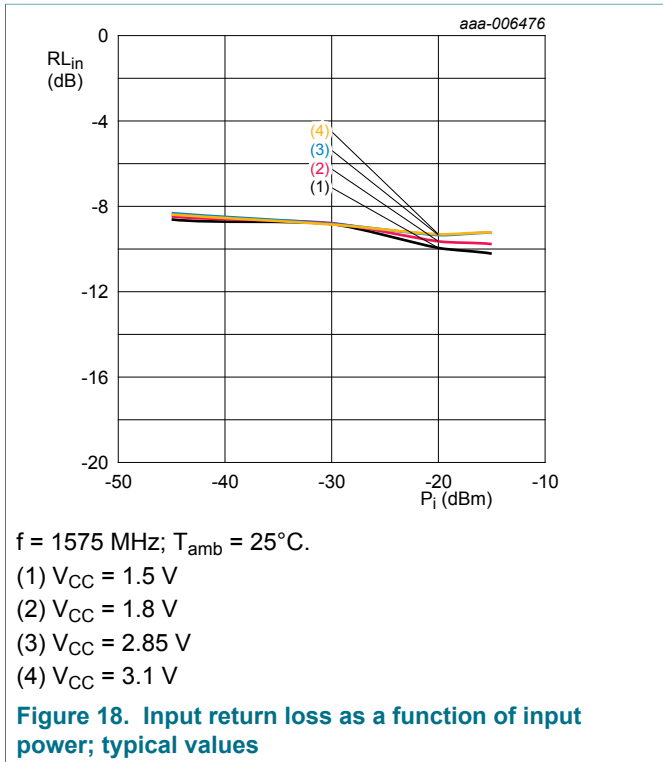
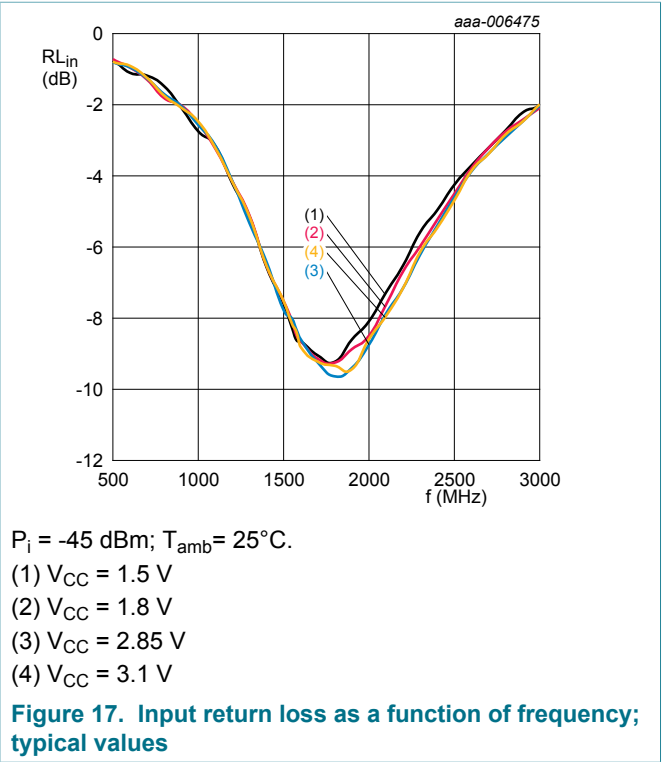
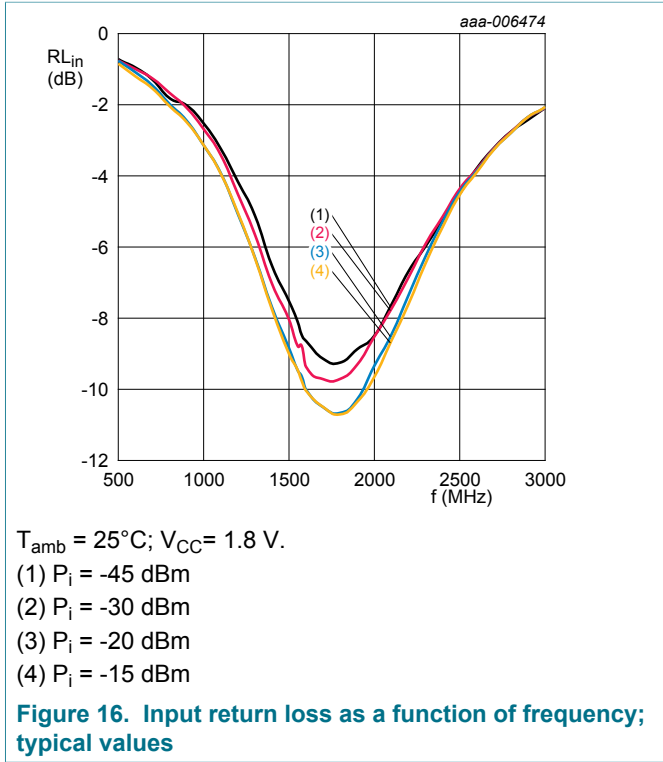

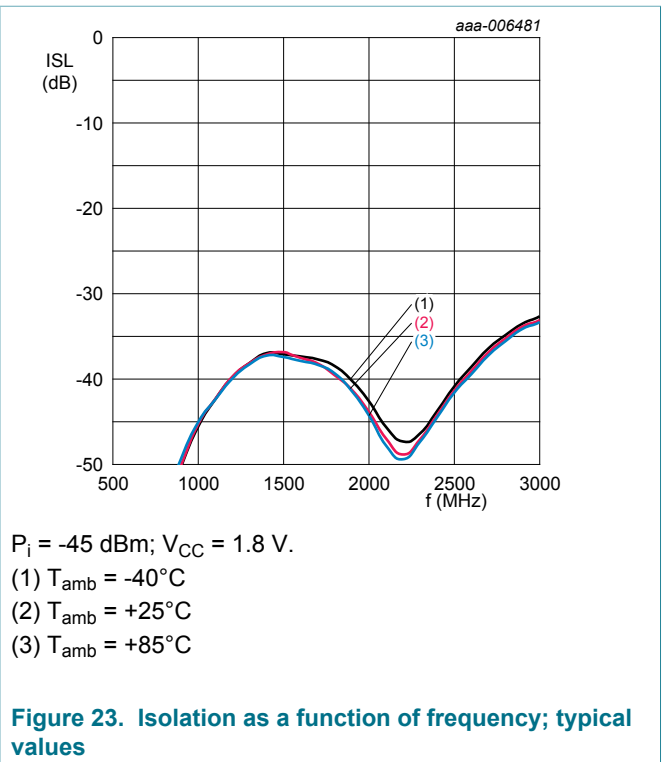
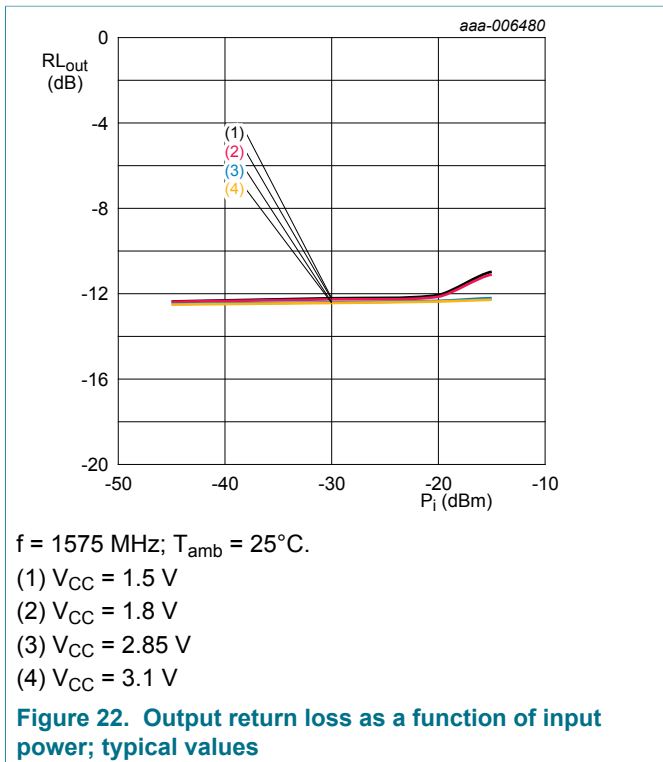
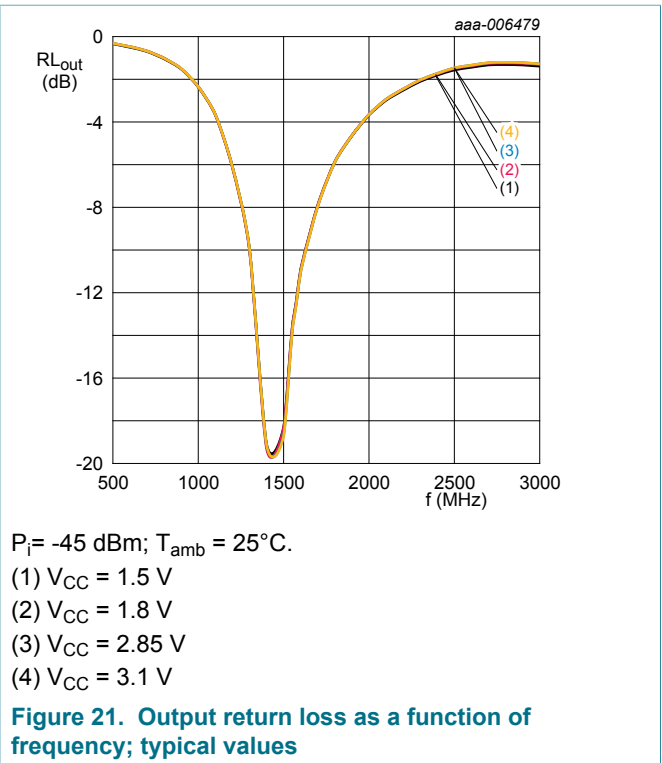
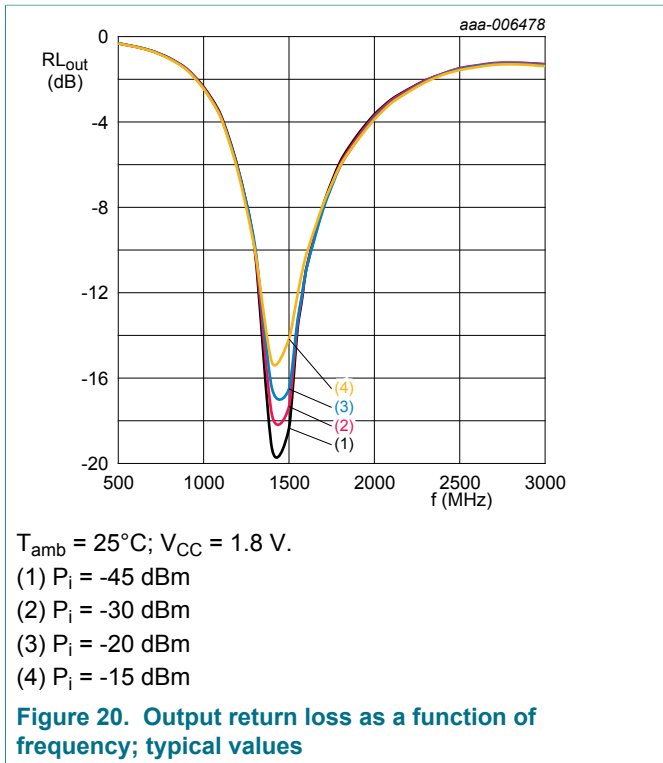

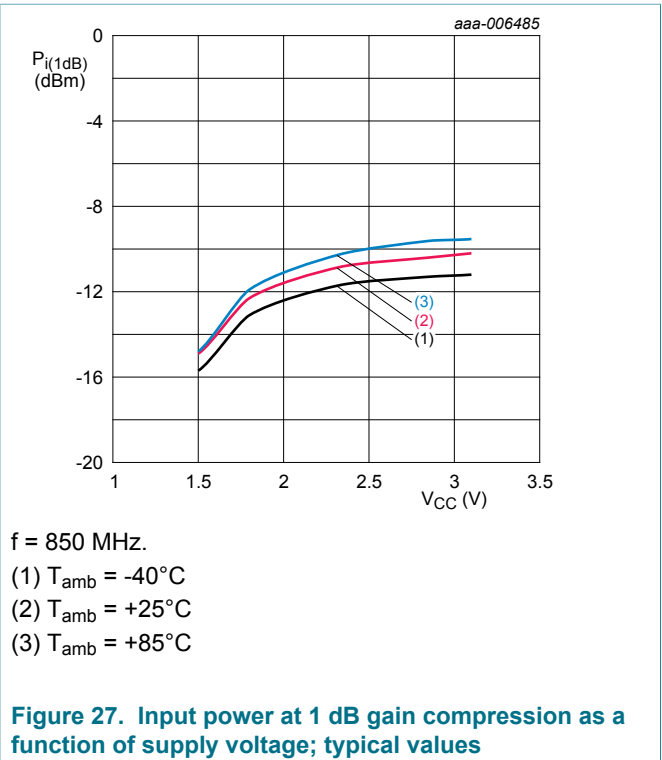
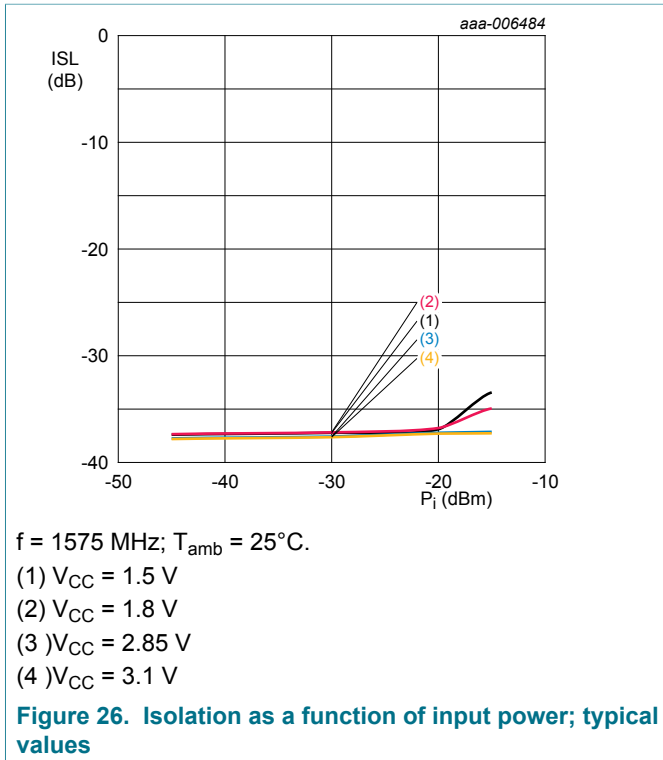
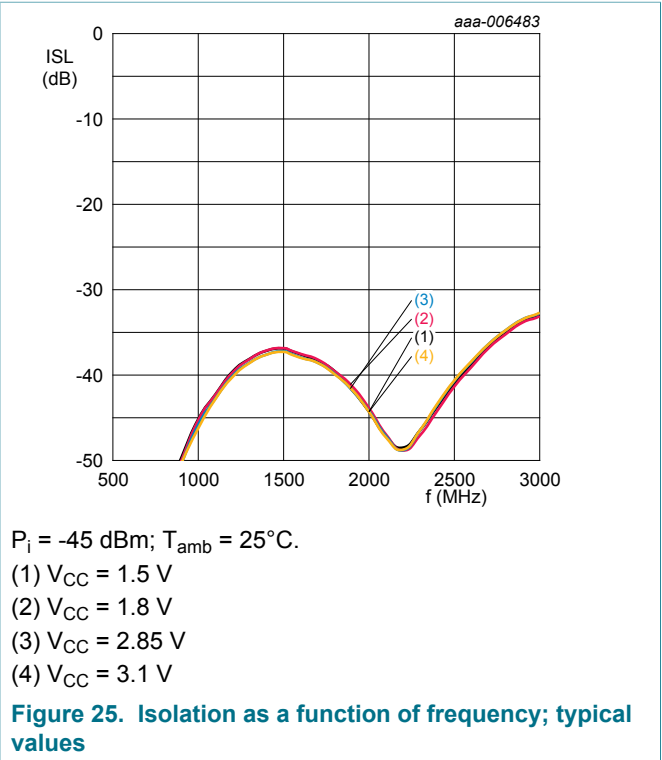
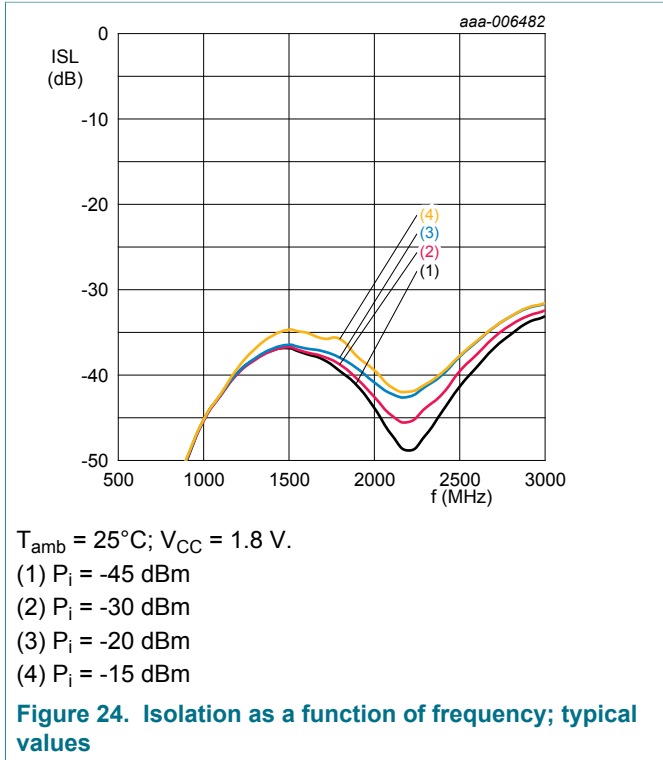

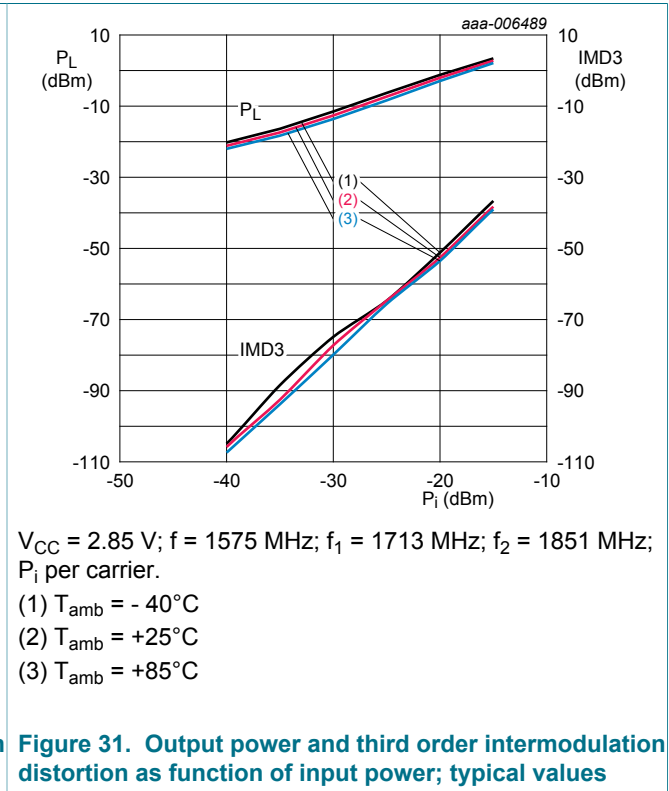
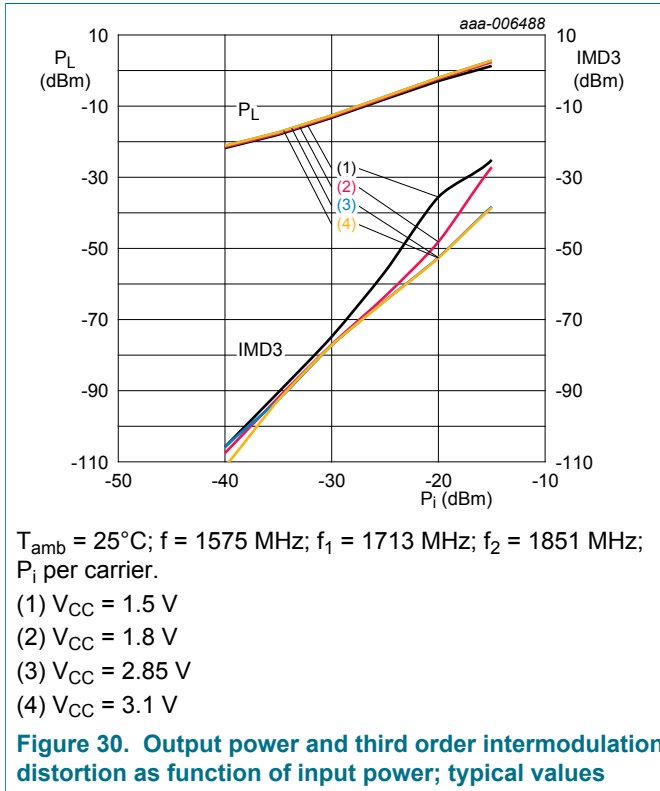
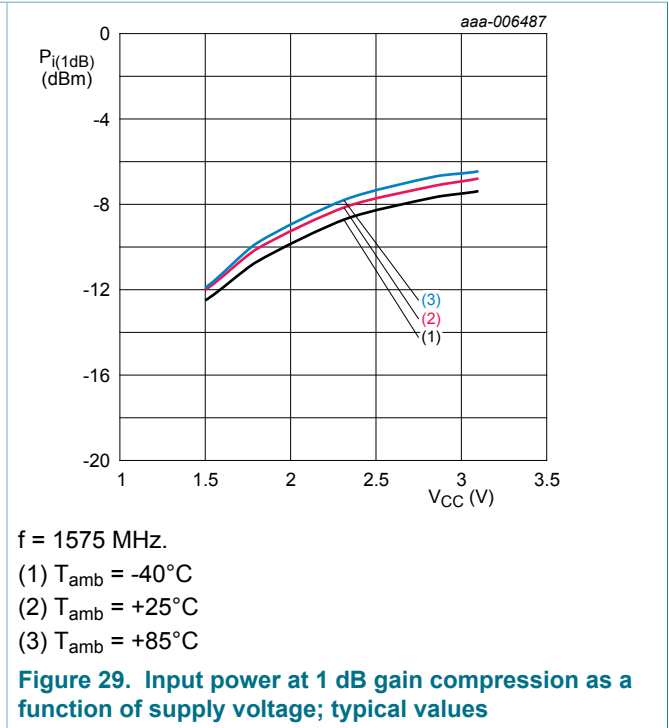
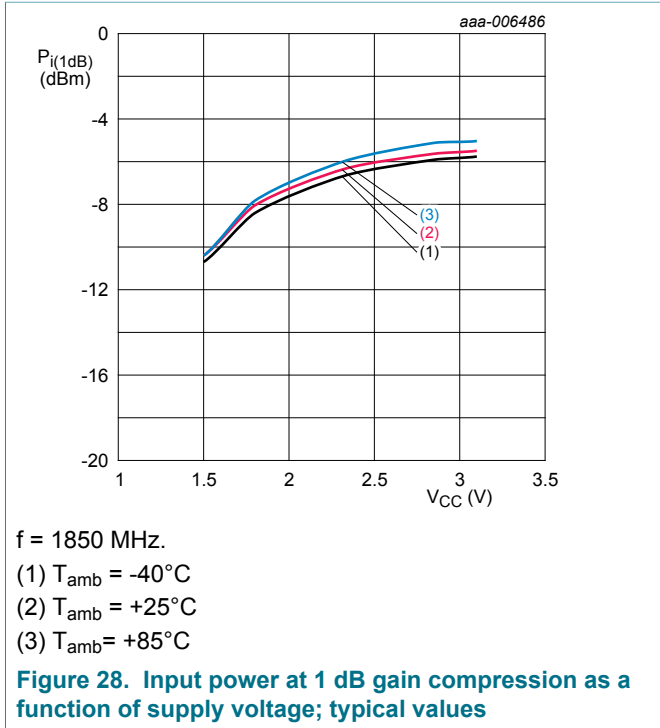

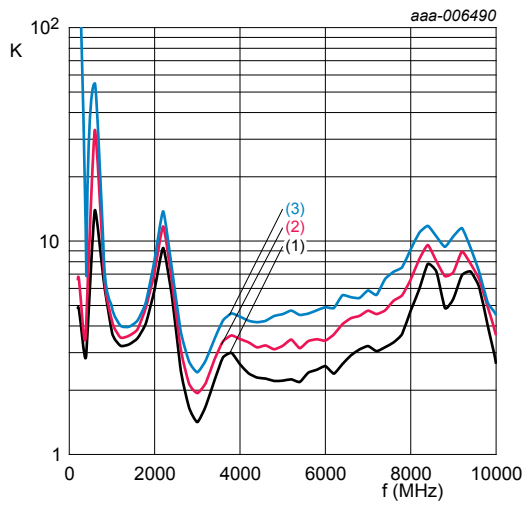

$V_{CC} = 1.8\text{ V}$ ;  $P_i = -45\text{ dBm}$ .

- (1)  $T_{amb} = -40^\circ\text{C}$
- (2)  $T_{amb} = +25^\circ\text{C}$
- (3)  $T_{amb} = +85^\circ\text{C}$

**Figure 32. Rollett stability factor as a function of frequency; typical values**

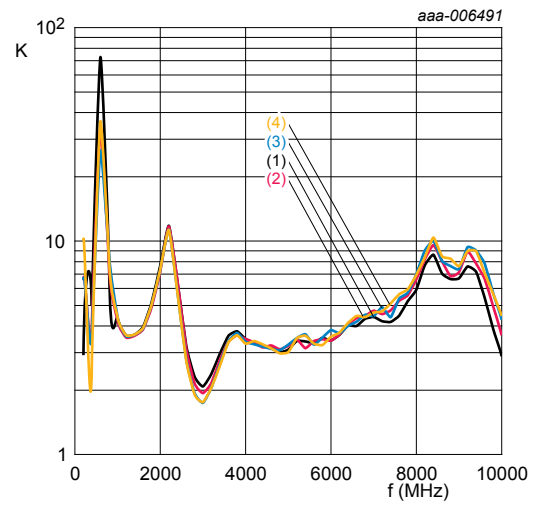

$T_{amb} = 25^\circ\text{C}$ ;  $P_i = -45\text{ dBm}$ .

- (1)  $V_{CC} = 1.5\text{ V}$
- (2)  $V_{CC} = 1.8\text{ V}$
- (3)  $V_{CC} = 2.85\text{ V}$
- (4)  $V_{CC} = 3.1\text{ V}$

**Figure 33. Rollett stability factor as a function of frequency; typical values**

## 14 Characteristics LTE B32

**Table 11. Characteristics**

1474 MHz;  $V_{CC} = 1.8\text{ V}$ ;  $P_i = -30\text{ dBm}$ ;  $T_{amb} = 25\text{ }^\circ\text{C}$ ; input matched  $50\ \Omega$  using application diagram from [Table 13](#) and component values as in [Figure 34](#). Unless otherwise specified.

Symbol	Parameter	Conditions	Min	Typ	Max	Unit
Gain Mode						
$I_{CC}$	supply current	$V_{I(ENABLE)} \geq 0.8\text{ V}$	-	4.4		mA
$G_p$	power gain		-	20	-	dB
$RL_{in}$	input return loss		-	17.5	-	dB
$RL_{out}$	output return loss		-	23.5	-	dB
ISL	isolation		-	36	-	dB
NF	noise figure		[1] [2]	0.65	-	dBm
$P_{i(1dB)}$	input power at 1 dB gain compression		[2]	-11	-	dBm
$IP3_i$	input third-order intercept point	$\Delta f = 1\text{ MHz}$ , $P_i = -30\text{ dBm}$	[2] [3]	-7	-	dBm
$t_{on}$	turn-on time	Time from $V_{I(CTRL)}$ ON to 90 % of the gain	-	-	2	$\mu\text{s}$
$t_{off}$	turn-off time	Time from $V_{I(CTRL)}$ OFF to 10 % of the gain	-	-	1	$\mu\text{s}$
K	Rollett stability factor		1	-	-	-

[1] PCB losses are subtracted.

[2] Guaranteed by device design; not tested in production.

[3]  $f_1 = 1474\text{ MHz}$ ,  $f_2 = 1475\text{ MHz}$

**Table 12. Characteristics**

1474 MHz;  $V_{CC} = 2.8\text{ V}$ ;  $P_i = -30\text{ dBm}$ ;  $T_{amb} = 25\text{ }^\circ\text{C}$ ; input matched  $50\ \Omega$  using application diagram from [Table 13](#) and component values as in [Figure 34](#). Unless otherwise specified.

Symbol	Parameter	Conditions	Min	Typ	Max	Unit
Gain Mode						
$I_{CC}$	supply current	$V_{I(ENABLE)} \geq 0.8\text{ V}$	-	4.6		mA
$G_p$	power gain		-	20	-	dB
$RL_{in}$	input return loss		-	17.5	-	dB
$RL_{out}$	output return loss		-	23.5	-	dB
ISL	isolation		-	36	-	dB
NF	noise figure		[1] [2]	0.65	-	dB
$P_{i(1dB)}$	input power at 1 dB gain compression		[2]	-8.5	-	dBm
$IP3_i$	input third-order intercept point	$\Delta f = 1\text{ MHz}$ , $P_i = -30\text{ dBm}$	[2] [3]	-6		dBm



Symbol	Parameter	Conditions	Min	Typ	Max	Unit
$t_{on}$	turn-on time	Time from $V_{I(CTRL)}$ ON to 90 % of the gain	-	-	2	$\mu s$
$t_{off}$	turn-off time	Time from $V_{I(CTRL)}$ OFF to 10 % of the gain	-	-	1	$\mu s$
K	Rollett stability factor		1	-	-	-

- [1] PCB losses are subtracted.
- [2] Guaranteed by device design; not tested in production.
- [3]  $f_1 = 1474$  MHz,  $f_2 = 1475$  MHz

## 15 Application information

### 15.1 GNSS and LTE B32 LNA

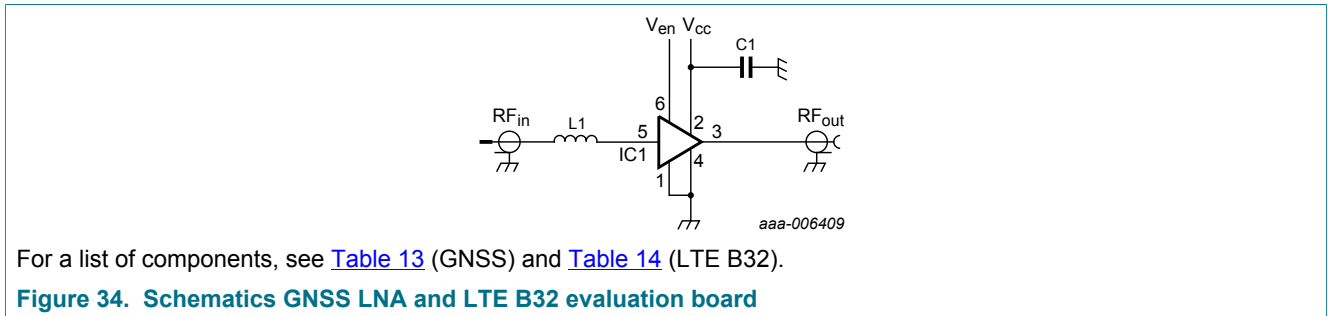

**Table 13. List of components for GNSS applications**

See [Figure 34](#) for schematics.

Component	Description	Value	Remarks
EVB	Evaluation Board	SOT1230 - EVB	EVB for GNSS application, NXP Semiconductors
C1	decoupling capacitor	1 nF	
IC1	BGU8009	-	NXP Semiconductors
L1	high-quality matching inductor	5.6 nH	GNSS band L1: $1559 < f < 1610$ MHz Murata LQW15A

Table 14. List of components for LTE B32 applications

See [Figure 34](#) for schematics.

Component	Description	Value	Remarks
EVB	Evaluation Board	OM17025 (SOT1230, SOT1232)	EVB for LTE application, NXP Semiconductors
C1	decoupling capacitor	1 nF	
IC1	BGU8009	-	NXP Semiconductors
L1	high-quality matching inductor	9.1 nH	LTE band 32 L1: 1452 < f < 1496 MHz Murata LQW15A

GNSS: See application note AN11288 for details. LTE B32: See application note AN11986.

16 Package outline

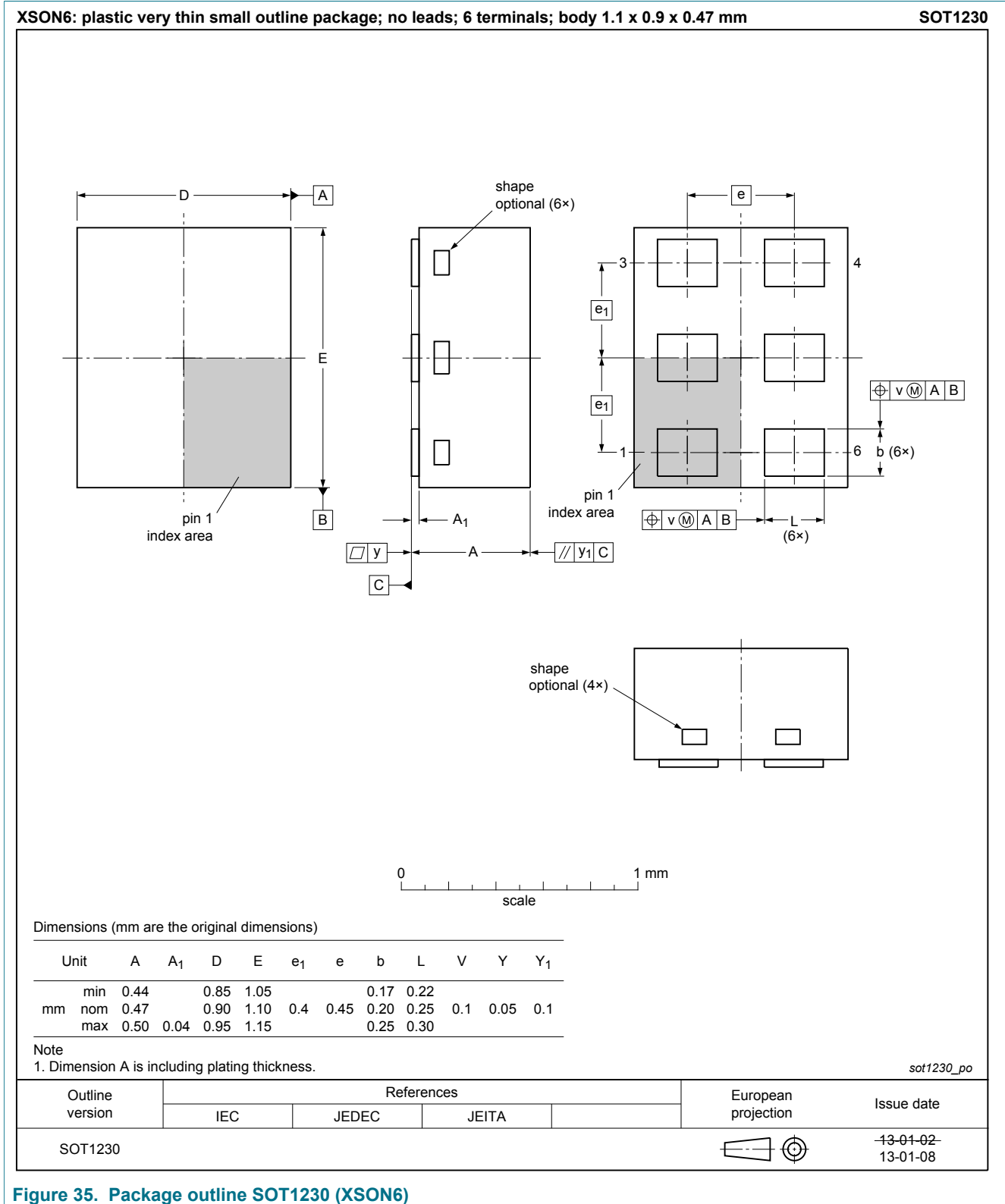

Figure 35. Package outline SOT1230 (XSON6)

## 17 Handling information



Figure 36. CAUTION

This device is sensitive to ElectroStatic Discharge (ESD). Observe precautions for handling electrostatic sensitive devices. Such precautions are described in the ANSI/ESD S20.20, IEC/ST 61340-5, JESD625-A or equivalent standards.

## 18 Abbreviations

Table 15. Abbreviations

Acronym	Description
GLONASS	Global Navigation Satellite System
GNSS	Global Navigation Satellite System
GPS	Global Positioning System
HBM	Human Body Model
MMIC	Monolithic Microwave Integrated Circuit
PCB	Printed-Circuit Board
SiGe:C	Silicon Germanium Carbon

## 19 Revision history

Table 16. Revision history

Document ID	Release date	Data sheet status	Change notice	Supersedes
BGU8009 v.7	20170720	Product data sheet	-	BGU8009 v.6
Modifications:	<ul style="list-style-type: none"> <li>• <a href="#">Section 1 "General description" on page 1</a>: added GPS1201M according to our new naming convention</li> <li>• <a href="#">Section 2 "Features and benefits" on page 1</a>: added LTE B32 characteristics</li> <li>• <a href="#">Section 14 "Characteristics LTE B32" on page 16</a> added</li> <li>• <a href="#">Table 13</a> added EVB</li> </ul>			
BGU8009 v.6	20170118	Product data sheet	-	BGU8009 v.5
Modifications:	<ul style="list-style-type: none"> <li>• <a href="#">Section 1</a>: added GPS1201M according to our new naming convention</li> </ul>			
BGU8009 v.5	20160405	Product data sheet	-	BGU8009 v.4
Modifications:	<ul style="list-style-type: none"> <li>• updated <a href="#">Figure 2 "Block diagram" on page 3</a></li> </ul>			
BGU8009 v.4	20160316	Product data sheet	-	BGU8009 v.3
Modifications:	<ul style="list-style-type: none"> <li>• updated <a href="#">Table 8 on page 5</a> and <a href="#">Table 9 on page 6</a></li> </ul>			
BGU8009 v.3	20141001	Product data sheet	-	BGU8009 v.2
Modifications:	<ul style="list-style-type: none"> <li>• Section 6.1 on page 3: Section has been added.</li> </ul>			
BGU8009 v.2	20130619	Product data sheet	-	BGU8009 v.1
BGU8009 v.1	20130201	Product data sheet	-	-

## 20 Legal information

### 20.1 Data sheet status

Document status <sup>[1][2]</sup>	Product status <sup>[3]</sup>	Definition
Objective [short] data sheet	Development	This document contains data from the objective specification for product development.
Preliminary [short] data sheet	Qualification	This document contains data from the preliminary specification.
Product [short] data sheet	Production	This document contains the product specification.

- [1] Please consult the most recently issued document before initiating or completing a design.
- [2] The term 'short data sheet' is explained in section "Definitions".
- [3] The product status of device(s) described in this document may have changed since this document was published and may differ in case of multiple devices. The latest product status information is available on the Internet at URL <http://www.nxp.com>.

### 20.2 Definitions

**Draft** — The document is a draft version only. The content is still under internal review and subject to formal approval, which may result in modifications or additions. NXP Semiconductors does not give any representations or warranties as to the accuracy or completeness of information included herein and shall have no liability for the consequences of use of such information.

**Short data sheet** — A short data sheet is an extract from a full data sheet with the same product type number(s) and title. A short data sheet is intended for quick reference only and should not be relied upon to contain detailed and full information. For detailed and full information see the relevant full data sheet, which is available on request via the local NXP Semiconductors sales office. In case of any inconsistency or conflict with the short data sheet, the full data sheet shall prevail.

**Product specification** — The information and data provided in a Product data sheet shall define the specification of the product as agreed between NXP Semiconductors and its customer, unless NXP Semiconductors and customer have explicitly agreed otherwise in writing. In no event however, shall an agreement be valid in which the NXP Semiconductors product is deemed to offer functions and qualities beyond those described in the Product data sheet.

### 20.3 Disclaimers

**Limited warranty and liability** — Information in this document is believed to be accurate and reliable. However, NXP Semiconductors does not give any representations or warranties, expressed or implied, as to the accuracy or completeness of such information and shall have no liability for the consequences of use of such information. NXP Semiconductors takes no responsibility for the content in this document if provided by an information source outside of NXP Semiconductors. In no event shall NXP Semiconductors be liable for any indirect, incidental, punitive, special or consequential damages (including - without limitation - lost profits, lost savings, business interruption, costs related to the removal or replacement of any products or rework charges) whether or not such damages are based on tort (including negligence), warranty, breach of contract or any other legal theory. Notwithstanding any damages that customer might incur for any reason whatsoever, NXP Semiconductors' aggregate and cumulative liability towards customer for the products described herein shall be limited in accordance with the Terms and conditions of commercial sale of NXP Semiconductors.

**Right to make changes** — NXP Semiconductors reserves the right to make changes to information published in this document, including without limitation specifications and product descriptions, at any time and without notice. This document supersedes and replaces all information supplied prior to the publication hereof.

**Suitability for use** — NXP Semiconductors products are not designed, authorized or warranted to be suitable for use in life support, life-critical or safety-critical systems or equipment, nor in applications where failure or malfunction of an NXP Semiconductors product can reasonably be expected to result in personal injury, death or severe property or environmental damage. NXP Semiconductors and its suppliers accept no liability for inclusion and/or use of NXP Semiconductors products in such equipment or applications and therefore such inclusion and/or use is at the customer's own risk.

**Applications** — Applications that are described herein for any of these products are for illustrative purposes only. NXP Semiconductors makes no representation or warranty that such applications will be suitable for the specified use without further testing or modification. Customers are responsible for the design and operation of their applications and products using NXP Semiconductors products, and NXP Semiconductors accepts no liability for any assistance with applications or customer product design. It is customer's sole responsibility to determine whether the NXP Semiconductors product is suitable and fit for the customer's applications and products planned, as well as for the planned application and use of customer's third party customer(s). Customers should provide appropriate design and operating safeguards to minimize the risks associated with their applications and products. NXP Semiconductors does not accept any liability related to any default, damage, costs or problem which is based on any weakness or default in the customer's applications or products, or the application or use by customer's third party customer(s). Customer is responsible for doing all necessary testing for the customer's applications and products using NXP Semiconductors products in order to avoid a default of the applications and the products or of the application or use by customer's third party customer(s). NXP does not accept any liability in this respect.

**Limiting values** — Stress above one or more limiting values (as defined in the Absolute Maximum Ratings System of IEC 60134) will cause permanent damage to the device. Limiting values are stress ratings only and (proper) operation of the device at these or any other conditions above those given in the Recommended operating conditions section (if present) or the Characteristics sections of this document is not warranted. Constant or repeated exposure to limiting values will permanently and irreversibly affect the quality and reliability of the device.

**Terms and conditions of commercial sale** — NXP Semiconductors products are sold subject to the general terms and conditions of commercial sale, as published at <http://www.nxp.com/profile/terms>, unless otherwise agreed in a valid written individual agreement. In case an individual agreement is concluded only the terms and conditions of the respective agreement shall apply. NXP Semiconductors hereby expressly objects to applying the customer's general terms and conditions with regard to the purchase of NXP Semiconductors products by customer.

**No offer to sell or license** — Nothing in this document may be interpreted or construed as an offer to sell products that is open for acceptance or the grant, conveyance or implication of any license under any copyrights, patents or other industrial or intellectual property rights.

**Quick reference data** — The Quick reference data is an extract of the product data given in the Limiting values and Characteristics sections of this document, and as such is not complete, exhaustive or legally binding.

**Export control** — This document as well as the item(s) described herein may be subject to export control regulations. Export might require a prior authorization from competent authorities.

**Non-automotive qualified products** — Unless this data sheet expressly states that this specific NXP Semiconductors product is automotive qualified, the product is not suitable for automotive use. It is neither qualified nor tested in accordance with automotive testing or application requirements. NXP Semiconductors accepts no liability for inclusion and/or use of non-automotive qualified products in automotive equipment or applications. In the event that customer uses the product for design-in and use in automotive applications to automotive specifications and standards, customer (a) shall use the product without NXP Semiconductors' warranty of the product for

such automotive applications, use and specifications, and (b) whenever customer uses the product for automotive applications beyond NXP Semiconductors' specifications such use shall be solely at customer's own risk, and (c) customer fully indemnifies NXP Semiconductors for any liability, damages or failed product claims resulting from customer design and use of the product for automotive applications beyond NXP Semiconductors' standard warranty and NXP Semiconductors' product specifications.

**Translations** — A non-English (translated) version of a document is for reference only. The English version shall prevail in case of any discrepancy between the translated and English versions.

## 20.4 Trademarks

Notice: All referenced brands, product names, service names and trademarks are the property of their respective owners.

## Contents

---

1	General description .....	1
2	Features and benefits .....	1
3	Applications .....	2
4	Quick reference data .....	2
5	Ordering information .....	3
6	Marking .....	3
6.1	Marking code description .....	3
7	Block diagram .....	4
8	Pinning information .....	4
8.1	Pinning .....	4
8.2	Pin description .....	4
9	Limiting values .....	5
10	Recommended operating conditions .....	5
11	Thermal characteristics .....	5
12	Characteristics GNSS band L1 .....	6
13	Graphs GNSS band L1 .....	8
14	Characteristics LTE B32 .....	16
15	Application information .....	17
15.1	GNSS and LTE B32 LNA .....	17
16	Package outline .....	19
17	Handling information .....	20
18	Abbreviations .....	20
19	Revision history .....	20
20	Legal information .....	21

---

Please be aware that important notices concerning this document and the product(s) described herein, have been included in section 'Legal information'.

---

© NXP B.V. 2017.

All rights reserved.

For more information, please visit: <http://www.nxp.com>

For sales office addresses, please send an email to: [salesaddresses@nxp.com](mailto:salesaddresses@nxp.com)

Date of release: 20 July 2017

Document number: