

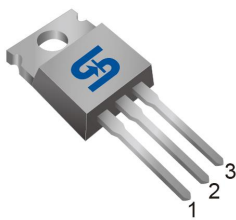

TO-220

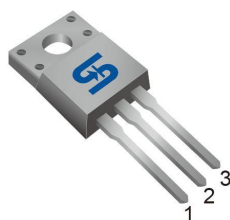

ITO-220



Pin Definition:

1. Gate
2. Drain
3. Source

Key Parameter Performance

Parameter	Value	Unit
V_{DS}	-60	V
$R_{DS(on)}$ (max)	$V_{GS} = -10V$	48
	$V_{GS} = -4.5V$	65
Q_g	22.4	nC

TO-251S (IPAK)

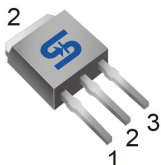

TO-252 (DPAK)

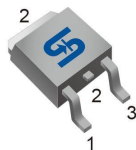

Ordering Information

Part No.	Package	Packing
TSM480P06CZ C0G	TO-220	50pcs / Tube
TSM480P06CI C0G	ITO-220	50pcs / Tube
TSM480P06CH X0G	TO-251S	75pcs / Tube
TSM480P06CP ROG	TO-252	2.5kpcs / 13+Reel

Note: %G+denotes for Halogen- and Antimony-free as those which contain <900ppm bromine, <900ppm chlorine (<1500ppm total Br + Cl) and <1000ppm antimony compounds

Block Diagram

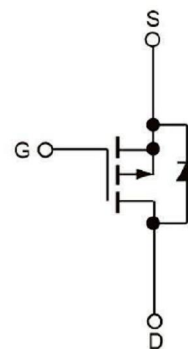

P-Channel MOSFET

Absolute Maximum Ratings ($T_c = 25^\circ C$ unless otherwise noted)

Parameter	Symbol	Limit			Unit
		IPAK/DPAK	ITO-220	TO-220	
Drain-Source Voltage	V_{DS}	-60			V
Gate-Source Voltage	V_{GS}	± 20			V
Continuous Drain Current ^(Note 1)	I_D	$T_c = 25^\circ C$			A
		$T_c = 100^\circ C$			A
Pulsed Drain Current ^(Note 2)	I_{DM}	-64			A
Single Pulse Avalanche Energy ^(Note 3)	E_{AS}	51			mJ
Single Pulse Avalanche Current ^(Note 2)	I_{AS}	-32			A
Power Dissipation @ $T_c = 25^\circ C$	P_D	40	27	66	W
Operating Junction Temperature	T_J	-50 to +150			$^\circ C$
Storage Temperature Range	T_{STG}	-50 to +150			$^\circ C$



Thermal Performance

Parameter	Symbol	Limit			Unit
		IPAK/DPAK	ITO-220	TO-220	
Thermal Resistance - Junction to Case	R_{JC}	3.1	4.7	1.9	°C/W
Thermal Resistance - Junction to Ambient	R_{JA}	62			°C/W

Electrical Specifications ($T_C = 25^\circ\text{C}$ unless otherwise noted)

Parameter	Conditions	Symbol	Min	Typ	Max	Unit
Static						
Drain-Source Breakdown Voltage	$V_{GS} = 0V, I_D = 250\mu A$	BV_{DSS}	-60	--	--	V
Drain-Source On-State Resistance	$V_{GS} = -10V, I_D = -8A$	$R_{DS(ON)}$	--	39	48	m
	$V_{GS} = -4.5V, I_D = -4A$		--	53	65	
Gate Threshold Voltage	$V_{DS} = V_{GS}, I_D = -250\mu A$	$V_{GS(TH)}$	-1.2	-1.6	-2.2	V
Zero Gate Voltage Drain Current	$V_{DS} = -60V, V_{GS} = 0V$	I_{DSS}	--	--	-1	μA
	$V_{DS} = -48V, T_C = 125^\circ\text{C}$		--	--	-10	
Gate Body Leakage	$V_{GS} = \pm 20V, V_{DS} = 0V$	I_{GSS}	--	--	± 100	nA
Forward Transconductance ^(Note 4)	$V_{DS} = -10V, I_D = -8A$	g_{fs}	--	10	--	S
Dynamic						
Total Gate Charge ^(Note 4,5)	$V_{DS} = -30V, I_D = -8A,$ $V_{GS} = -10V$	Q_g	--	22.4	--	nC
Gate-Source Charge ^(Note 4,5)		Q_{gs}	--	4.1	--	
Gate-Drain Charge ^(Note 4,5)		Q_{gd}	--	5.2	--	
Input Capacitance	$V_{DS} = -30V, V_{GS} = 0V,$ $f = 1.0\text{MHz}$	C_{iss}	--	1250	--	pF
Output Capacitance		C_{oss}	--	85	--	
Reverse Transfer Capacitance		C_{rss}	--	65	--	
Switching						
Turn-On Delay Time ^(Note 4,5)	$V_{DD} = -30V, I_D = -1A,$ $R_{GEN} = 6$	$t_{d(on)}$	--	13	--	ns
Turn-On Rise Time ^(Note 4,5)		t_r	--	42.4	--	
Turn-Off Delay Time ^(Note 4,5)		$t_{d(off)}$	--	64.6	--	
Turn-Off Fall Time ^(Note 4,5)		t_f	--	16.4	--	
Source-Drain Diode Ratings and Characteristic						
Maximum Continuous Drain-Source Diode Forward Current	Integral reverse diode in the MOSFET	I_S	--	--	-16	A
Maximum Pulse Drain-Source Diode Forward Current		I_{SM}	--	--	-64	A
Diode-Source Forward Voltage	$V_{GS} = 0V, I_S = -1A$	V_{SD}	--	--	-1	V

Note:

- Limited by maximum junction temperature
- Pulse width limited by safe operating area
- $L = 3.68\text{mH}, I_{AS} = 8A, V_{DD} = 50V, R_G = 25 \Omega$, Starting $T_J = 25^\circ\text{C}$
- Pulse test: pulse width $m300\mu s$, duty cycle $m2\%$
- Switching time is essentially independent of operating temperature



Electrical Characteristics Curve

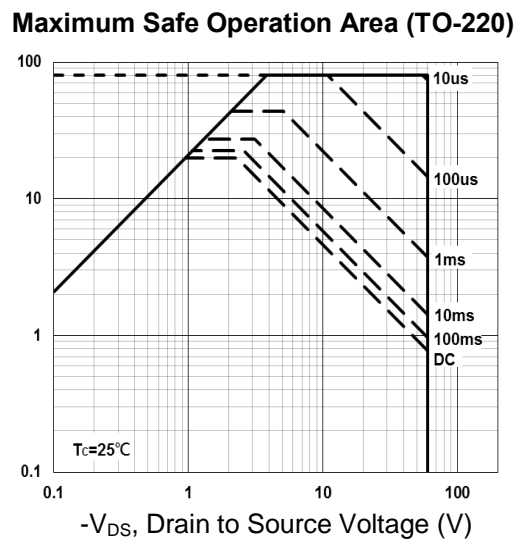
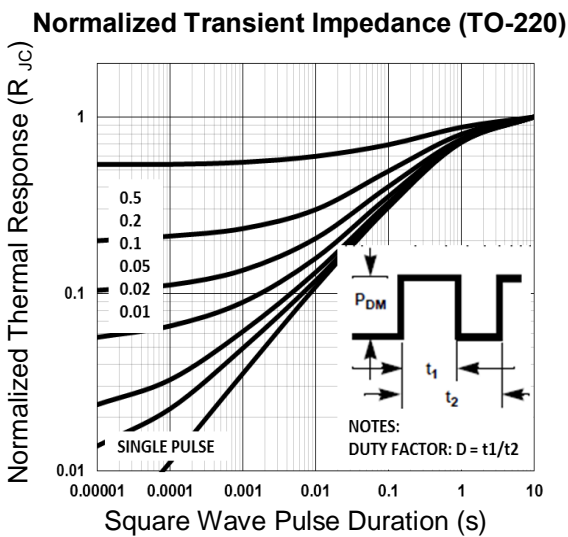
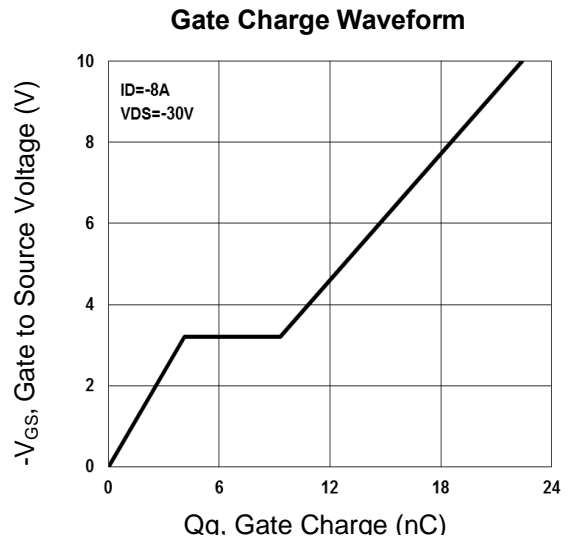
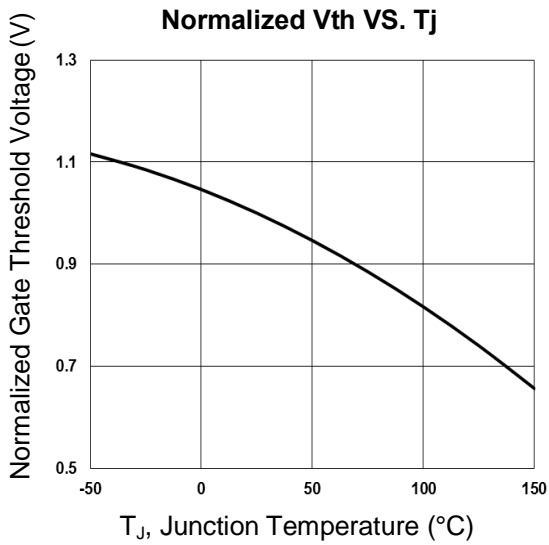
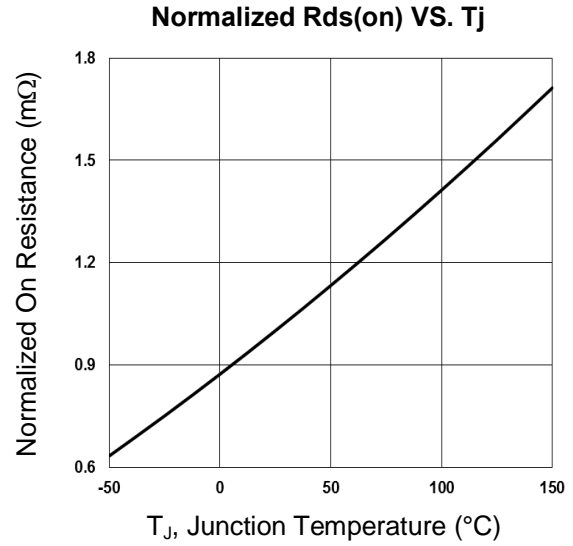
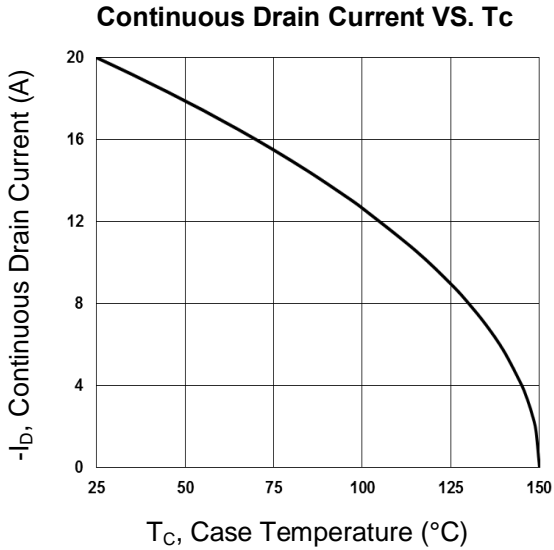



Electrical Characteristics Curve

Normalized Transient Impedance (ITO-220)

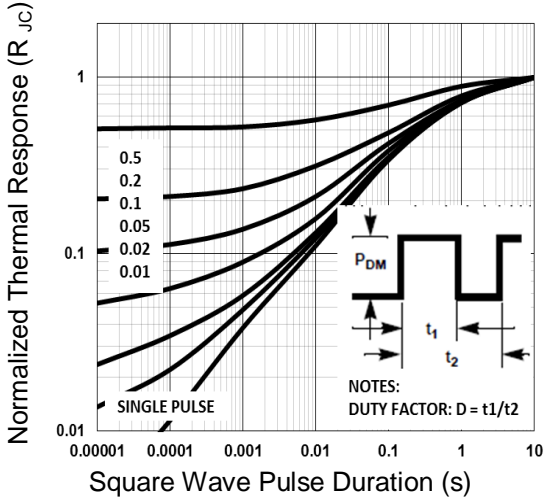

Maximum Safe Operation Area (ITO-220)

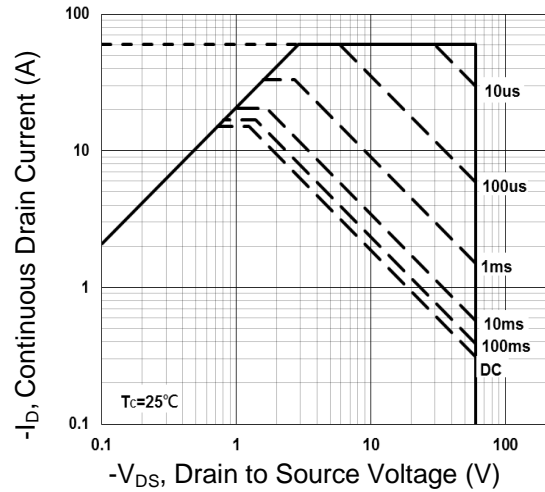

Normalized Transient Impedance (TO-251S)

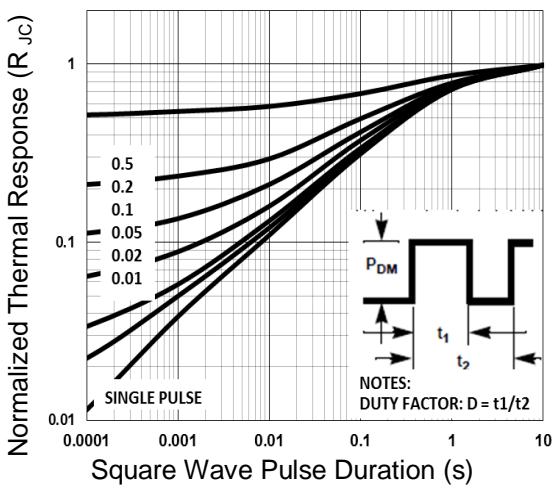

Maximum Safe Operation Area (TO-251S)

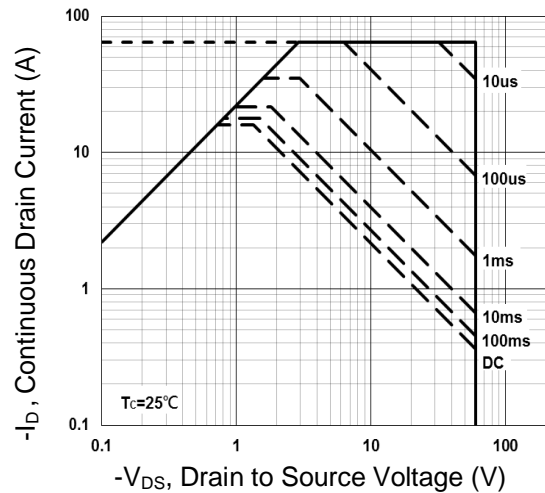

Normalized Transient Impedance (TO-252)

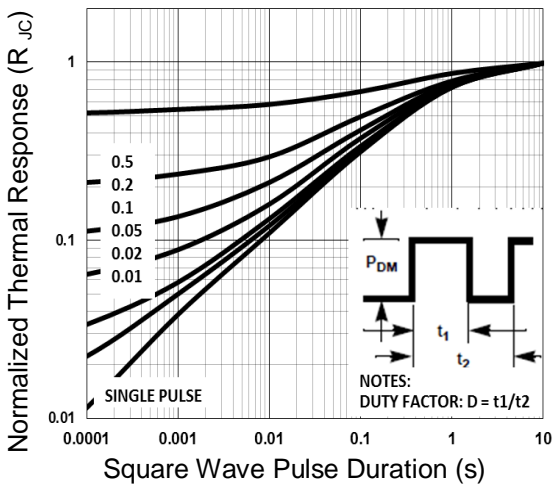

Maximum Safe Operation Area (TO-252)

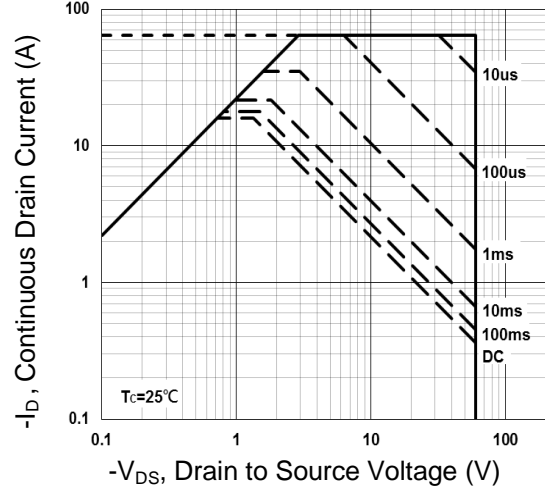



TO-220 Mechanical Drawing

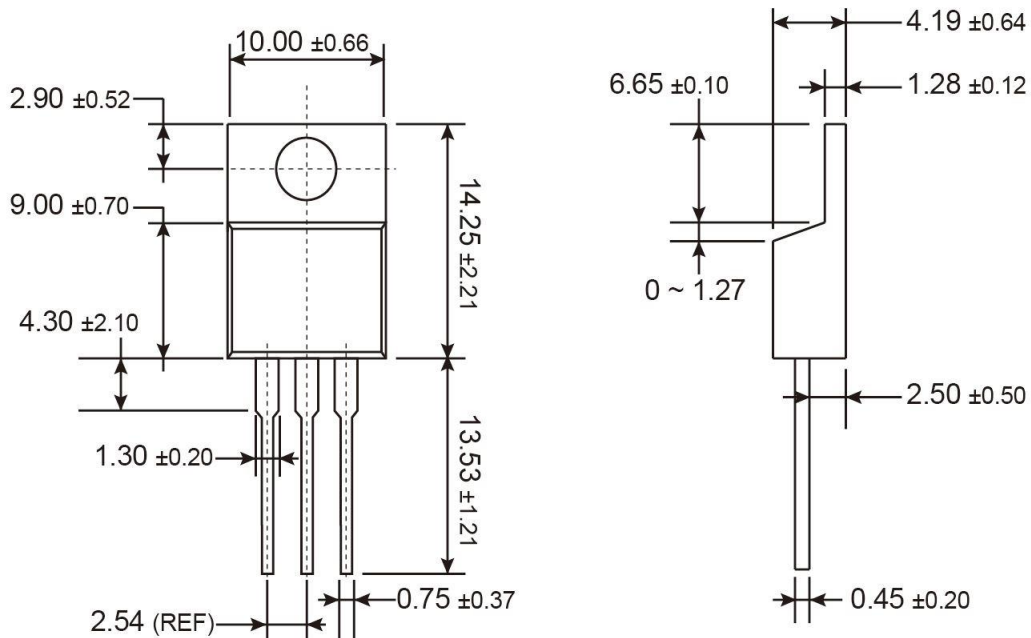

Unit: Millimeters

Marking Diagram

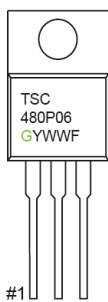

- G** = Halogen Free
- Y** = Year Code
- WW** = Week Code (01~52)
- F** = Factory Code



ITO-220 Mechanical Drawing

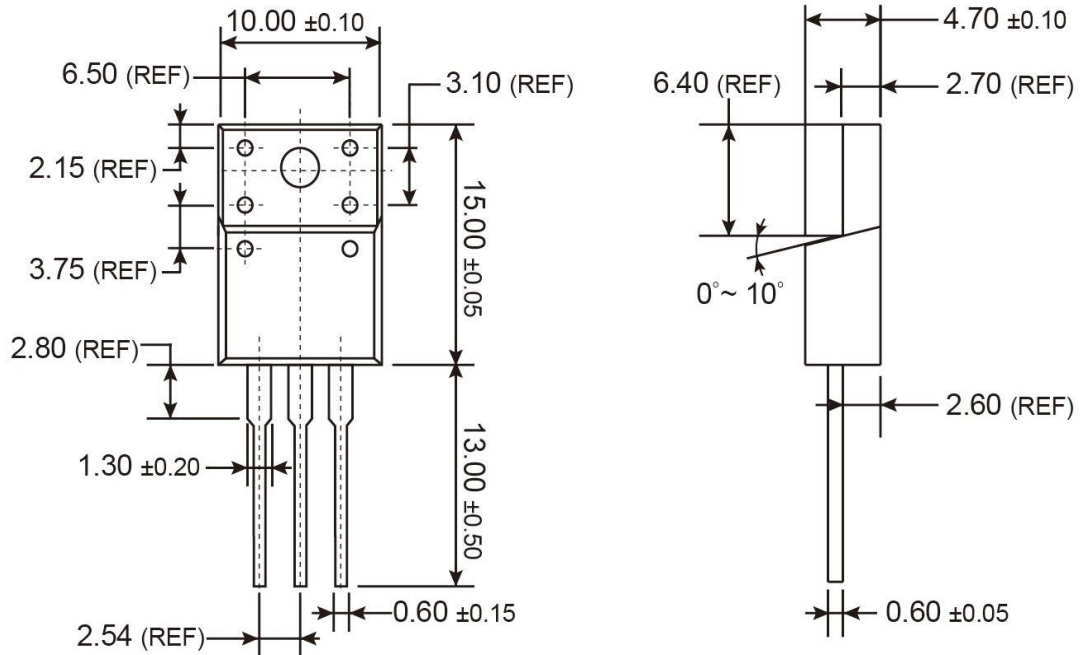

Unit: Millimeters

Marking Diagram



- G** = Halogen Free
- Y** = Year Code
- WW** = Week Code (01~52)
- F** = Factory Code



TO-251S Mechanical Drawing

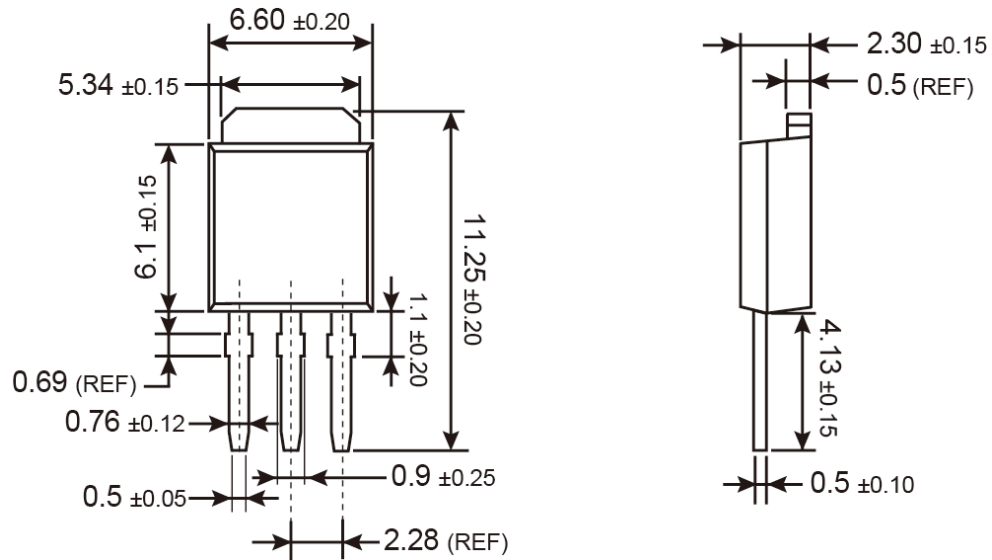

Unit: Millimeters

Marking Diagram

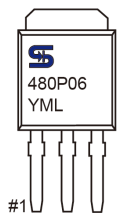

- Y** = Year Code
- M** = Month Code for Halogen Free Product
(**O**=Jan, **P**=Feb, **Q**=Mar, **R**=Apr, **S**=May, **T**=Jun, **U**=Jul, **V**=Aug, **W**=Sep, **X**=Oct, **Y**=Nov, **Z**=Dec)
- L** = Lot Code



TO-252 Mechanical Drawing

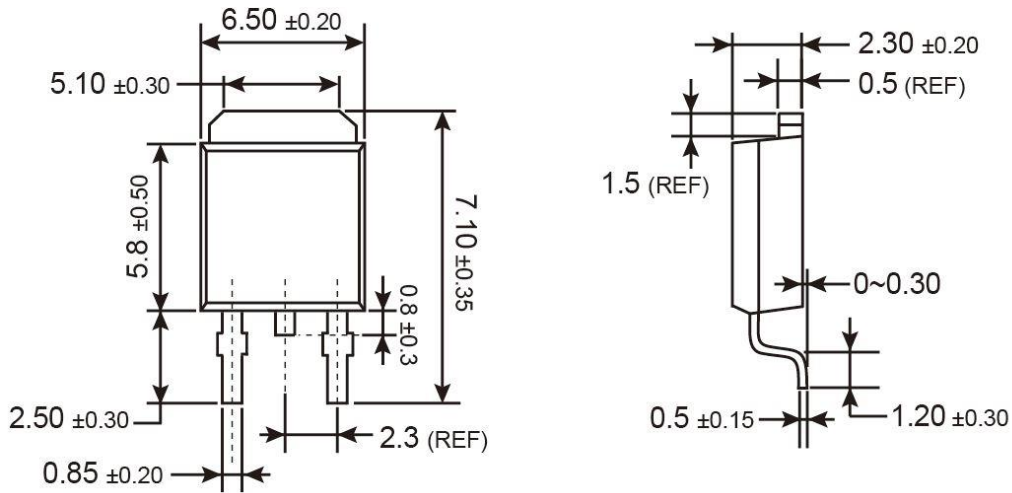

Unit: Millimeters

Marking Diagram

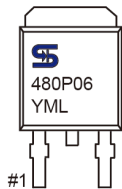

- Y** = Year Code
- M** = Month Code for Halogen Free Product
(**O**=Jan, **P**=Feb, **Q**=Mar, **R**=Apr, **S**=May, **T**=Jun, **U**=Jul, **V**=Aug, **W**=Sep, **X**=Oct, **Y**=Nov, **Z**=Dec)
- L** = Lot Code

Notice

Specifications of the products displayed herein are subject to change without notice. TSC or anyone on its behalf, assumes no responsibility or liability for any errors or inaccuracies.

Information contained herein is intended to provide a product description only. No license, express or implied, to any intellectual property rights is granted by this document. Except as provided in TSC's terms and conditions of sale for such products, TSC assumes no liability whatsoever, and disclaims any express or implied warranty, relating to sale and/or use of TSC products including liability or warranties relating to fitness for a particular purpose, merchantability, or infringement of any patent, copyright, or other intellectual property right.

The products shown herein are not designed for use in medical, life-saving, or life-sustaining applications. Customers using or selling these products for use in such applications do so at their own risk and agree to fully indemnify TSC for any damages resulting from such improper use or sale.