

# 74LVC2G04

## Dual Inverter

### GENERAL DESCRIPTION

The 74LVC2G04 contains two independent inverters and it is designed for 1.65V to 5.5V  $V_{CC}$  operation. The device performs the Boolean function  $Y = \bar{A}$ .

Inputs can be driven from either 3.3V or 5V devices. This feature allows the use of this device as a translator in a mixed 3.3V and 5V environment.

This device is fully specified for partial power-down applications using  $I_{OFF}$ . The  $I_{OFF}$  circuitry disables the output, preventing the damaging backflow current through the device when it is powered down.

### FEATURES

- 5V Tolerant Inputs for Interfacing with 5V Logic
- Wide Supply Voltage Range: 1.65V to 5.5V
- High Noise Immunity
- $\pm 24\text{mA}$  Output Drive at  $V_{CC} = 3.0\text{V}$
- CMOS Low Power Consumption
- Direct Interface with TTL Levels
- Inputs Accept Voltages up to 5V
- $-40^\circ\text{C}$  to  $+125^\circ\text{C}$  Operating Temperature Range
- Available in a Green SOT-23-6 Package

### LOGIC SYMBOL

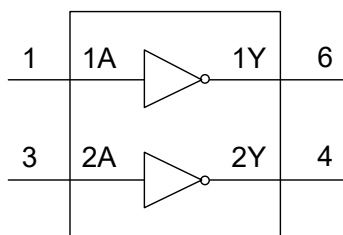

### FUNCTION TABLE

INPUT	OUTPUT
nA	nY
L	H
H	L

H = High Voltage Level

L = Low Voltage Level

### LOGIC DIAGRAM

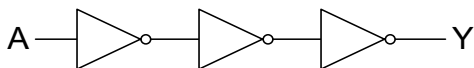

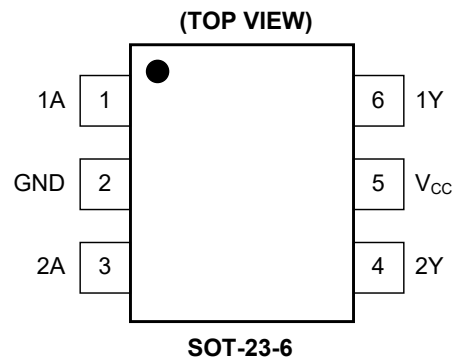

---

**PIN CONFIGURATION****PIN DESCRIPTION**

PIN	NAME	FUNCTION
1, 3	1A, 2A	Data Inputs.
2	GND	Ground.
4, 6	2Y, 1Y	Data Outputs.
5	V <sub>cc</sub>	Supply Voltage.

**ELECTRICAL CHARACTERISTICS**(Full = -40°C to +125°C, all typical values are measured at  $V_{CC} = 3.3V$  and  $T_A = +25^\circ C$ , unless otherwise noted.)

PARAMETER	SYMBOL	CONDITIONS	TEMP	MIN	TYP	MAX	UNITS	
High-Level Input Voltage	$V_{IH}$	$V_{CC} = 1.65V$ to 1.95V	Full	$0.65 \times V_{CC}$			V	
		$V_{CC} = 2.3V$ to 2.7V	Full	1.7				
		$V_{CC} = 2.7V$ to 3.6V	Full	2				
		$V_{CC} = 4.5V$ to 5.5V	Full	$0.7 \times V_{CC}$				
Low-Level Input Voltage	$V_{IL}$	$V_{CC} = 1.65V$ to 1.95V	Full			$0.35 \times V_{CC}$	V	
		$V_{CC} = 2.3V$ to 2.7V	Full			0.7		
		$V_{CC} = 2.7V$ to 3.6V	Full			0.8		
		$V_{CC} = 4.5V$ to 5.5V	Full			$0.3 \times V_{CC}$		
High-Level Output Voltage	$V_{OH}$	$V_I = V_{IH}$ or $V_{IL}$	$V_{CC} = 1.65V$ to 5.5V, $I_o = -100\mu A$	Full	$V_{CC} - 0.05$	$V_{CC} - 0.01$	V	
			$V_{CC} = 1.65V$ , $I_o = -4mA$	Full	1.43	1.55		
			$V_{CC} = 2.3V$ , $I_o = -8mA$	Full	2.02	2.18		
			$V_{CC} = 2.7V$ , $I_o = -12mA$	Full	2.38	2.56		
			$V_{CC} = 3.0V$ , $I_o = -24mA$	Full	2.52	2.74		
			$V_{CC} = 4.5V$ , $I_o = -32mA$	Full	4	4.22		
Low-Level Output Voltage	$V_{OL}$	$V_I = V_{IH}$ or $V_{IL}$	$V_{CC} = 1.65V$ to 5.5V, $I_o = 100\mu A$	Full		0.01	0.05	V
			$V_{CC} = 1.65V$ , $I_o = 4mA$	Full		0.1	0.22	
			$V_{CC} = 2.3V$ , $I_o = 8mA$	Full		0.12	0.28	
			$V_{CC} = 2.7V$ , $I_o = 12mA$	Full		0.16	0.34	
			$V_{CC} = 3.0V$ , $I_o = 24mA$	Full		0.3	0.56	
			$V_{CC} = 4.5V$ , $I_o = 32mA$	Full		0.32	0.6	
Input Leakage Current	$I_I$	$V_{CC} = 0V$ to 5.5V, $V_I = 5.5V$ or GND	Full		$\pm 0.01$	$\pm 1$	$\mu A$	
Power-Off Leakage Current	$I_{OFF}$	$V_{CC} = 0V$ , $V_I$ or $V_o = 5.5V$	Full		$\pm 0.01$	$\pm 1$	$\mu A$	
Supply Current	$I_{CC}$	$V_{CC} = 1.65V$ to 5.5V, $V_I = 5.5V$ or GND, $I_o = 0A$	Full		0.01	1	$\mu A$	
Additional Supply Current	$\Delta I_{CC}$	Per pin, $V_{CC} = 2.3V$ to 5.5V, $V_I = V_{CC} - 0.6V$ , $I_o = 0A$	Full		0.05	10	$\mu A$	
Input Capacitance	$C_I$	$V_{CC} = 3.3V$ , $V_I = GND$ to $V_{CC}$	+25°C		3.5		pF	

**DYNAMIC CHARACTERISTICS**

(For test circuit, see Figure 1. Full = -40°C to +125°C, all typical values are measured at  $T_A = +25^\circ\text{C}$  and  $V_{CC} = 1.8\text{V}, 2.5\text{V}, 2.7\text{V}, 3.3\text{V}$  and  $5.0\text{V}$  respectively, unless otherwise noted.)

PARAMETER	SYMBOL	CONDITIONS	TEMP	MIN <sup>(1)</sup>	TYP	MAX <sup>(1)</sup>	UNITS	
Propagation Delay <sup>(2)</sup>	$t_{PD}$	nA to nY, see Figure 2	$V_{CC} = 1.65\text{V to } 1.95\text{V}$	Full	0.5	6.0	14.0	ns
			$V_{CC} = 2.3\text{V to } 2.7\text{V}$	Full	0.5	3.2	7.0	
			$V_{CC} = 2.7\text{V}$	Full	0.5	3.1	7.5	
			$V_{CC} = 3.0\text{V to } 3.6\text{V}$	Full	0.1	3.5	6.0	
			$V_{CC} = 4.5\text{V to } 5.5\text{V}$	Full	0.1	3.1	5.5	
Power Dissipation Capacitance <sup>(3)</sup>	$C_{PD}$	$V_{CC} = 3.3\text{V}, V_I = \text{GND to } V_{CC}$	+25°C		30.5		pF	

## NOTES:

- Specified by design and characterization; not production tested.
- $t_{PD}$  is the same as  $t_{PLH}$  and  $t_{PHL}$ .
- $C_{PD}$  is used to determine the dynamic power dissipation ( $P_D$  in  $\mu\text{W}$ ).

$$P_D = C_{PD} \times V_{CC}^2 \times f_i \times N + \Sigma(C_L \times V_{CC}^2 \times f_o)$$

where:

$f_i$  = Input frequency in MHz.

$f_o$  = Output frequency in MHz.

$C_L$  = Output load capacitance in pF.

$V_{CC}$  = Supply voltage in Volts.

$N$  = Number of inputs switching.

$\Sigma(C_L \times V_{CC}^2 \times f_o)$  = Sum of outputs.

## TEST CIRCUIT

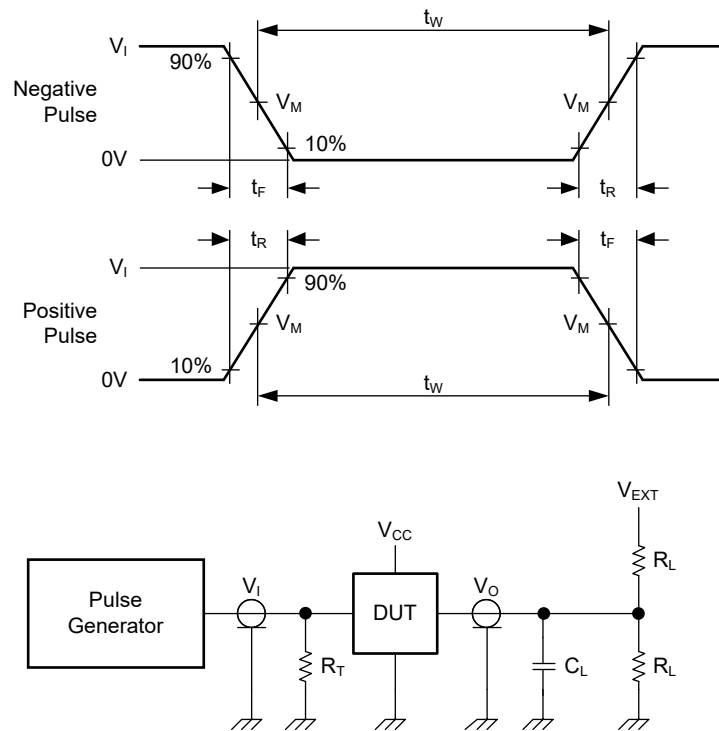

Test conditions are given in Table 1.

Definitions for test circuit:

$R_L$  = Load resistance.

$C_L$  = Load capacitance including jig and probe capacitance.

$R_T$  = Termination resistance should be equal to the output impedance  $Z_O$  of the pulse generator.

$V_{EXT}$  = External voltage for measuring switching times.

Figure 1. Test Circuit for Measuring Switching Times

Table 1. Test Conditions

SUPPLY VOLTAGE	INPUT		LOAD		$V_{EXT}$
$V_{CC}$	$V_I$	$t_R = t_F$	$C_L$	$R_L$	$t_{PLH}, t_{PHL}$
1.65V to 1.95V	$V_{CC}$	$\leq 2.0\text{ns}$	30pF	1k $\Omega$	Open
2.3V to 2.7V	$V_{CC}$	$\leq 2.0\text{ns}$	30pF	500 $\Omega$	Open
2.7V	2.7V	$\leq 2.5\text{ns}$	50pF	500 $\Omega$	Open
3.0V to 3.6V	2.7V	$\leq 2.5\text{ns}$	50pF	500 $\Omega$	Open
4.5V to 5.5V	$V_{CC}$	$\leq 2.5\text{ns}$	50pF	500 $\Omega$	Open

WAVEFORMS

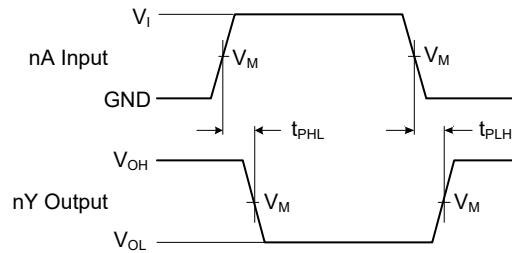

Test conditions are given in Table 1.

Measurement points are given in Table 2.

Logic levels:  $V_{OL}$  and  $V_{OH}$  are typical output voltage levels that occur with the output load.

Figure 2. Input nA to Output nY Propagation Delays

Table 2. Measurement Points

SUPPLY VOLTAGE	INPUT	OUTPUT
$V_{CC}$	$V_M^{(1)}$	$V_M$
1.65V to 1.95V	$0.5V_{CC}$	$0.5V_{CC}$
2.3V to 2.7V	$0.5V_{CC}$	$0.5V_{CC}$
2.7V	1.5V	1.5V
3.0V to 3.6V	1.5V	1.5V
4.5V to 5.5V	$0.5V_{CC}$	$0.5V_{CC}$

NOTE:

1. The measurement points should be  $V_{IH}$  or  $V_{IL}$  when the input rising or falling time exceeds 2.5ns.

REVISION HISTORY

NOTE: Page numbers for previous revisions may differ from page numbers in the current version.

NOVEMBER 2021 – REV.A to REV.A.1	Page
Updated Dynamic Characteristics section.....	5
Added note of Table 2 .....	7
Changes from Original (FEBRUARY 2021) to REV.A	Page
Changed from product preview to production data.....	All

PACKAGE OUTLINE DIMENSIONS

SOT-23-6

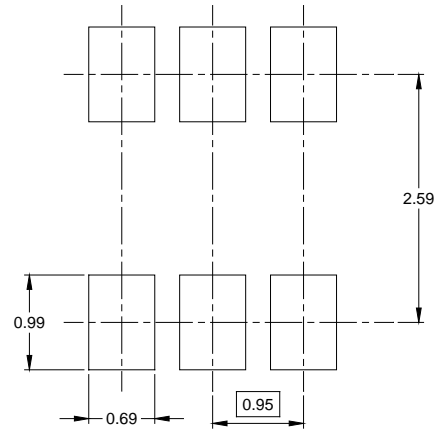
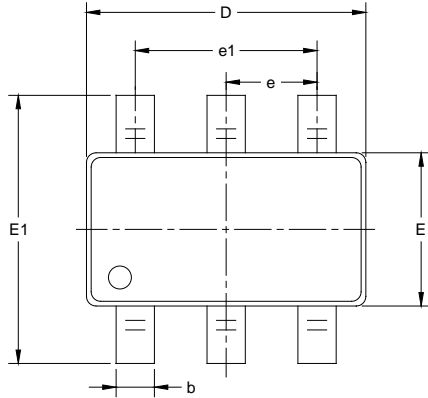

RECOMMENDED LAND PATTERN (Unit: mm)

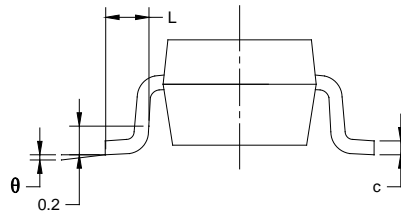
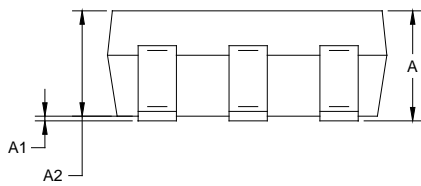

Symbol	Dimensions In Millimeters		Dimensions In Inches	
	MIN	MAX	MIN	MAX
A	1.050	1.250	0.041	0.049
A1	0.000	0.100	0.000	0.004
A2	1.050	1.150	0.041	0.045
b	0.300	0.500	0.012	0.020
c	0.100	0.200	0.004	0.008
D	2.820	3.020	0.111	0.119
E	1.500	1.700	0.059	0.067
E1	2.650	2.950	0.104	0.116
e	0.950 BSC		0.037 BSC	
e1	1.900 BSC		0.075 BSC	
L	0.300	0.600	0.012	0.024
$\theta$	0°	8°	0°	8°

NOTES:

1. Body dimensions do not include mode flash or protrusion.
2. This drawing is subject to change without notice.



# PACKAGE INFORMATION

## TAPE AND REEL INFORMATION

### REEL DIMENSIONS



### TAPE DIMENSIONS



NOTE: The picture is only for reference. Please make the object as the standard.

### KEY PARAMETER LIST OF TAPE AND REEL

Package Type	Reel Diameter	Reel Width W1 (mm)	A0 (mm)	B0 (mm)	K0 (mm)	P0 (mm)	P1 (mm)	P2 (mm)	W (mm)	Pin1 Quadrant
SOT-23-6	7"	9.5	3.17	3.23	1.37	4.0	4.0	2.0	8.0	Q3

DD0001

# PACKAGE INFORMATION

## CARTON BOX DIMENSIONS



NOTE: The picture is only for reference. Please make the object as the standard.

## KEY PARAMETER LIST OF CARTON BOX

Reel Type	Length (mm)	Width (mm)	Height (mm)	Pizza/Carton
7" (Option)	368	227	224	8
7"	442	410	224	18

DD0002