

# Single and Dual Low Voltage, Rail-to-Rail Input and Output, Operational Amplifiers

## LMV931, LMV932

The LMV931 Single and LMV932 Dual are CMOS low-voltage operational amplifiers which can operate on single-sided power supplies (1.8 V to 5.0 V) with rail-to-rail input and output swing. Both devices come in small state-of-the-art packages and require very low quiescent current making them ideal for battery-operated, portable applications such as notebook computers and hand-held instruments. Rail-to-Rail operation provides improved signal-to-noise performance plus the small packages allow for closer placement to signal sources thereby reducing noise pickup.

The single LMV931 is offered in space saving SC70-5 package. The dual LMV932 is in either a Micro8 or SOIC package. These small packages are very beneficial for crowded PCB's.

### Features

- Performance Specified on Single-Sided Power Supply: 1.8 V, 2.7 V, and 5 V
- Small Packages:
  - LMV931 in a SC-70
  - LMV932 in a Micro8 or SOIC-8
- No Output Crossover Distortion
- Extended Industrial Temperature Range:  $-40^{\circ}\text{C}$  to  $+125^{\circ}\text{C}$
- Low Quiescent Current 210  $\mu\text{A}$ , Max Per Channel
- No Output Phase-Reversal from Overdriven Input
- These are Pb-Free Devices

### Typical Applications

- Notebook Computers, Portable Battery-Operated Instruments, PDA's
- Active Filters, Low-Side Current Monitoring

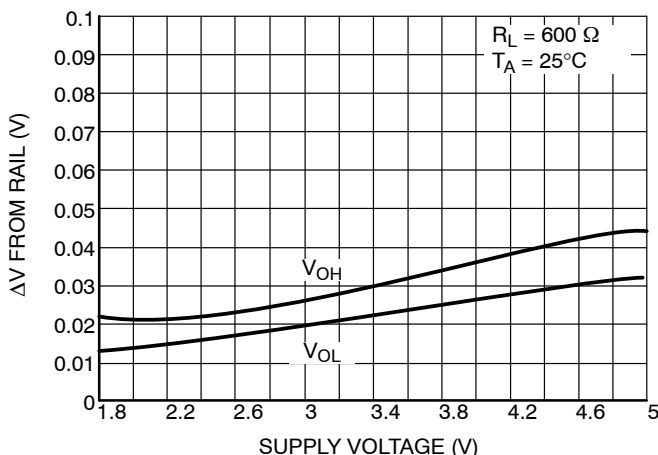

Figure 1. Output Voltage Swing vs. Supply Voltage

### MARKING DIAGRAMS

#### LMV931 (Single)



SC-70  
CASE 419A

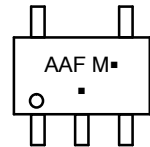

TSOP-5  
CASE 483

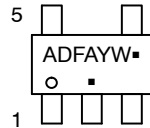

M = Date Code  
A = Assembly Location  
Y = Year  
W = Work Week  
▪ = Pb-Free Package

(Note: Microdot may be in either location)

#### LMV932 (Dual)



Micro8  
CASE 846A

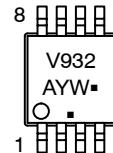

SOIC-8  
CASE 751

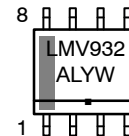

A = Assembly Location  
Y = Year  
L = Wafer Lot  
W = Work Week  
▪ = Pb-Free Package

(Note: Microdot may be in either location)

### ORDERING INFORMATION

See detailed ordering and shipping information in the package dimensions section on page 14 of this data sheet.

# LMV931, LMV932

## PIN CONNECTIONS

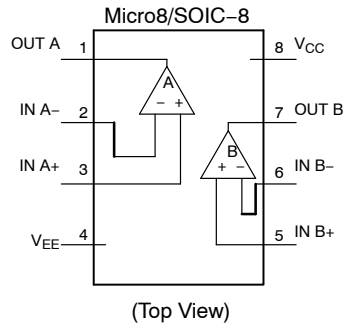
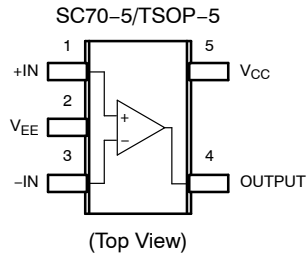

## MAXIMUM RATINGS

Symbol	Rating	Value	Unit
$V_S$	Supply Voltage (Operating Range $V_S = 1.8\text{ V to }5.5\text{ V}$ )	5.5	V
$V_{IDR}$	Input Differential Voltage	$\pm$ Supply Voltage	V
$V_{ICR}$	Input Common Mode Voltage Range	$-0.5\text{ to }(V_{CC}) + 0.5$	V
	Maximum Input Current	10	mA
$t_{SO}$	Output Short Circuit (Note 1)	Continuous	
$T_J$	Maximum Junction Temperature (Operating Range $-40^\circ\text{C to }85^\circ\text{C}$ )	150	$^\circ\text{C}$
$\theta_{JA}$	Thermal Resistance:	SC-70 TSOP-5 Micro8	$^\circ\text{C/W}$
$T_{stg}$	Storage Temperature	$-65\text{ to }150$	$^\circ\text{C}$
	Mounting Temperature (Infrared or Convection $\leq 30\text{ sec}$ )	260	$^\circ\text{C}$

Stresses exceeding those listed in the Maximum Ratings table may damage the device. If any of these limits are exceeded, device functionality should not be assumed, damage may occur and reliability may be affected.

ESD data available upon request.

1. Continuous short-circuit operation to ground at elevated ambient temperature can result in exceeding the maximum allowed junction temperature of  $150^\circ\text{C}$ . Output currents in excess of 45 mA over long term may adversely affect reliability. Shorting output to either  $V_{CC}$  or  $V_{EE}$  will adversely affect reliability.

## LMV931, LMV932

**1.8 V DC ELECTRICAL CHARACTERISTICS** (Note 2) Unless otherwise noted, all min/max limits are guaranteed for  $T_A = 25^\circ\text{C}$ ,  $V_S = 1.8\text{ V}$ ,  $V_{CM} = V_S/2$ ,  $V_O = V_S/2$  and  $R_L > 1\text{ M}\Omega$ . Typical specifications represent the most likely parametric norm.

Parameter	Symbol	Condition	Min	Typ	Max	Unit
Input Offset Voltage	$V_{IO}$	LMV931 (Single) ( $-40^\circ\text{C}$ to $+125^\circ\text{C}$ )		1	6	mV
		LMV932 (Dual) ( $-40^\circ\text{C}$ to $+125^\circ\text{C}$ )		1	7.5	
Input Offset Voltage Average Drift	$TCV_{IO}$			5.5		$\mu\text{V}/^\circ\text{C}$
Input Bias Current	$I_B$	$-40^\circ\text{C}$ to $+125^\circ\text{C}$		< 1		nA
Input Offset Current	$I_{IO}$	$-40^\circ\text{C}$ to $+125^\circ\text{C}$		< 1		nA
Supply Current (per Channel)	$I_{CC}$	In Active Mode		75	185	$\mu\text{A}$
		$-40^\circ\text{C}$ to $+125^\circ\text{C}$			205	
Common Mode Rejection Ratio	CMRR	$0\text{ V} \leq V_{CM} \leq 0.6\text{ V}$ , $1.4\text{ V} \leq V_{CM} \leq 1.8\text{ V}$	50	70		dB
		$-40^\circ\text{C}$ to $+125^\circ\text{C}$	50			
		$-0.2\text{ V} \leq V_{CM} \leq 0\text{ V}$ , $1.8\text{ V} \leq V_{CM} \leq 2\text{ V}$	50	70		
Power Supply Rejection Ratio	PSRR	$1.8\text{ V} \leq V^+ \leq 5\text{ V}$ , $V_{CM} = 0.5\text{ V}$	50	70		dB
		$-40^\circ\text{C}$ to $+125^\circ\text{C}$	50			
Input Common-Mode Voltage Range	VCM	For CMRR $\geq 50\text{ dB}$ and $T_A = 25^\circ\text{C}$	$V_{EE} - 0.2$	$-0.2$ to $2.1$	$V_{CC} + 0.2$	V
		For CMRR $\geq 50\text{ dB}$ and $T_A = -40^\circ\text{C}$ to $+85^\circ\text{C}$	$V_{EE}$		$V_{CC}$	
		For CMRR $\geq 50\text{ dB}$ and $T_A = -40^\circ\text{C}$ to $+125^\circ\text{C}$	$V_{EE} + 0.2$		$V_{CC} - 0.2$	
Large Signal Voltage Gain LMV931 (Single)	$A_V$	$R_L = 600\ \Omega$ to $0.9\text{ V}$ , $V_O = 0.2\text{ V}$ to $1.6\text{ V}$ , $V_{CM} = 0.5\text{ V}$	77	101		dB
		$-40^\circ\text{C}$ to $+125^\circ\text{C}$	73			
		$R_L = 2\text{ k}\Omega$ to $0.9\text{ V}$ , $V_O = 0.2\text{ V}$ to $1.6\text{ V}$ , $V_{CM} = 0.5\text{ V}$	80	105		
		$-40^\circ\text{C}$ to $+125^\circ\text{C}$	75			
Large Signal Voltage Gain LMV932 (Dual)	$A_V$	$R_L = 600\ \Omega$ to $0.9\text{ V}$ , $V_O = 0.2\text{ V}$ to $1.6\text{ V}$ , $V_{CM} = 0.5\text{ V}$	75	90		dB
		$-40^\circ\text{C}$ to $+125^\circ\text{C}$	72			
		$R_L = 2\text{ k}\Omega$ to $0.9\text{ V}$ , $V_O = 0.2\text{ V}$ to $1.6\text{ V}$ , $V_{CM} = 0.5\text{ V}$	78	100		
		$-40^\circ\text{C}$ to $+125^\circ\text{C}$	75			
Output Swing	$V_{OH}$	$R_L = 600\ \Omega$ to $0.9\text{ V}$ , $V_{IN} = \pm 100\text{ mV}$	1.65	1.72		V
		$-40^\circ\text{C}$ to $+125^\circ\text{C}$	1.63			
	$V_{OL}$	$R_L = 600\ \Omega$ to $0.9\text{ V}$ , $V_{IN} = \pm 100\text{ mV}$		0.077	0.105	
		$-40^\circ\text{C}$ to $+125^\circ\text{C}$			0.12	
	$V_{OH}$	$R_L = 2\text{ k}\Omega$ to $0.9\text{ V}$ , $V_{IN} = \pm 100\text{ mV}$	1.75	1.77		
		$-40^\circ\text{C}$ to $+125^\circ\text{C}$	1.74			
	$V_{OL}$	$R_L = 2\text{ k}\Omega$ to $0.9\text{ V}$ , $V_{IN} = \pm 100\text{ mV}$		0.24	0.035	
		$-40^\circ\text{C}$ to $+125^\circ\text{C}$			0.04	
Output Short Circuit Current	$I_O$	Sourcing, $V_O = 0\text{ V}$ , $V_{IN} = +100\text{ mV}$	4.0	30		mA
		$-40^\circ\text{C}$ to $+125^\circ\text{C}$	3.3			
		Sinking, $V_O = 1.8\text{ V}$ , $V_{IN} = -100\text{ mV}$	7.0	60		
		$-40^\circ\text{C}$ to $+125^\circ\text{C}$	5.0			

2. Guaranteed by design and/or characterization.

## LMV931, LMV932

**1.8 V AC ELECTRICAL CHARACTERISTICS** Unless otherwise specified, all limits are guaranteed for  $T_A = 25^\circ\text{C}$ ,  $V_S = 1.8\text{ V}$ ,  $V_{CM} = V_S/2$ ,  $V_O = V_S/2$  and  $R_L > 1\text{ M}\Omega$ . Typical specifications represent the most likely parametric norm. Min/Max specifications are guaranteed by testing, characterization, or statistical analysis.

Parameter	Symbol	Condition	Min	Typ	Max	Unit
Slew Rate	SR	(Note 3)		0.35		V/ $\mu\text{S}$
Gain Bandwidth Product	GBWP			1.4		MHz
Phase Margin	$\Theta_m$			67		$^\circ$
Gain Margin	Gm			7		dB
Input-Referred Voltage Noise	$e_n$	$f = 50\text{ kHz}$ , $V_{CM} = 0.5\text{ V}$		60		nV/ $\sqrt{\text{Hz}}$
Total Harmonic Distortion	THD	$f = 1\text{ kHz}$ , $A_V = +1$ , $R_L = 600\ \Omega$ , $V_O = 1\text{ V}_{PP}$		0.023		%
Amplifier-to-Amplifier Isolation		(Note 4)		123		dB

3. Connected as voltage follower with input step from  $V_{EE}$  to  $V_{CC}$ . Number specified is the slower of the positive and negative slew rates.
4. Input referred,  $R_L = 100\text{ k}\Omega$  connected to  $V_S/2$ . Each amp excited in turn with 1 kHz to produce  $V_O = 3\text{ V}_{PP}$ . (For Supply Voltages  $< 3\text{ V}$ ,  $V_O = V_{CC}$ ).

## LMV931, LMV932

**2.7 V DC ELECTRICAL CHARACTERISTICS** (Note 5) Unless otherwise noted, all min/max limits are guaranteed for  $T_A = 25^\circ\text{C}$ ,  $V_S = 2.7\text{ V}$ ,  $V_{CM} = V_S/2$ ,  $V_O = V_S/2$  and  $R_L > 1\text{ M}\Omega$ . Typical specifications represent the most likely parametric norm.

Parameter	Symbol	Condition	Min	Typ	Max	Unit
Input Offset Voltage	$V_{IO}$	LMV931 (Single) ( $-40^\circ\text{C}$ to $+125^\circ\text{C}$ )		1	6	mV
		LMV932 (Dual) ( $-40^\circ\text{C}$ to $+125^\circ\text{C}$ )		1	7.5	
Input Offset Voltage Average Drift	$TCV_{IO}$			5.5		$\mu\text{V}/^\circ\text{C}$
Input Bias Current	$I_B$	$-40^\circ\text{C}$ to $+125^\circ\text{C}$		< 1		nA
Input Offset Current	$I_{IO}$	$-40^\circ\text{C}$ to $+125^\circ\text{C}$		< 1		nA
Supply Current (per Channel)	$I_{CC}$	In Active Mode		80	190	$\mu\text{A}$
		$-40^\circ\text{C}$ to $+125^\circ\text{C}$			210	
Common Mode Rejection Ratio	CMRR	$0\text{ V} \leq V_{CM} \leq 1.5\text{ V}$ , $2.3\text{ V} \leq V_{CM} \leq 2.7\text{ V}$	50	70		dB
		$-40^\circ\text{C}$ to $+125^\circ\text{C}$	50			
		$-0.2\text{ V} \leq V_{CM} \leq 0\text{ V}$ , $2.7\text{ V} \leq V_{CM} \leq 2.9\text{ V}$	50	70		
Power Supply Rejection Ratio	PSRR	$1.8\text{ V} \leq V^+ \leq 5\text{ V}$ , $V_{CM} = 0.5\text{ V}$	50	70		dB
		$-40^\circ\text{C}$ to $+125^\circ\text{C}$	50			
Input Common-Mode Voltage Range	VCM	For CMRR $\geq 50\text{ dB}$ and $T_A = 25^\circ\text{C}$	$V_{EE} - 0.2$	$-0.2$ to $3.0$	$V_{CC} + 0.2$	V
		For CMRR $\geq 50\text{ dB}$ and $T_A = -40^\circ\text{C}$ to $+85^\circ\text{C}$	$V_{EE}$		$V_{CC}$	
		For CMRR $\geq 50\text{ dB}$ and $T_A = -40^\circ\text{C}$ to $+125^\circ\text{C}$	$V_{EE} + 0.2$		$V_{CC} - 0.2$	
Large Signal Voltage Gain LMV931 (Single)	$A_V$	$R_L = 600\ \Omega$ to $1.35\text{ V}$ , $V_O = 0.2\text{ V}$ to $2.5\text{ V}$	87	104		dB
		$-40^\circ\text{C}$ to $+125^\circ\text{C}$	86			
		$R_L = 2\text{ k}\Omega$ to $1.35\text{ V}$ , $V_O = 0.2\text{ V}$ to $2.5\text{ V}$	92	110		
		$-40^\circ\text{C}$ to $+125^\circ\text{C}$	91			
Large Signal Voltage Gain LMV932 (Dual)	$A_V$	$R_L = 600\ \Omega$ to $1.35\text{ V}$ , $V_O = 0.2\text{ V}$ to $2.5\text{ V}$	78	90		dB
		$-40^\circ\text{C}$ to $+125^\circ\text{C}$	75			
		$R_L = 2\text{ k}\Omega$ to $1.35\text{ V}$ , $V_O = 0.2\text{ V}$ to $2.5\text{ V}$	81	100		
		$-40^\circ\text{C}$ to $+125^\circ\text{C}$	78			
Output Swing	$V_{OH}$	$R_L = 600\ \Omega$ to $1.35\text{ V}$ , $V_{IN} = \pm 100\text{ mV}$	2.55	2.62		V
		$-40^\circ\text{C}$ to $+125^\circ\text{C}$	2.53			
	$V_{OL}$	$R_L = 600\ \Omega$ to $1.35\text{ V}$ , $V_{IN} = \pm 100\text{ mV}$		0.083	0.11	
		$-40^\circ\text{C}$ to $+125^\circ\text{C}$			0.13	
	$V_{OH}$	$R_L = 2\text{ k}\Omega$ to $1.35\text{ V}$ , $V_{IN} = \pm 100\text{ mV}$	2.65	2.675		
		$-40^\circ\text{C}$ to $+125^\circ\text{C}$	2.64			
	$V_{OL}$	$R_L = 2\text{ k}\Omega$ to $1.35\text{ V}$ , $V_{IN} = \pm 100\text{ mV}$		0.025	0.04	
		$-40^\circ\text{C}$ to $+125^\circ\text{C}$			0.045	
Output Short Circuit Current	$I_O$	Sourcing, $V_o = 0\text{ V}$ , $V_{IN} = \pm 100\text{ mV}$	20	65		mA
		$-40^\circ\text{C}$ to $+125^\circ\text{C}$	15			
		Sinking, $V_o = 0\text{ V}$ , $V_{IN} = -100\text{ mV}$	18	75		
		$-40^\circ\text{C}$ to $+125^\circ\text{C}$	12			

5. Guaranteed by design and/or characterization.

## LMV931, LMV932

**2.7 V AC ELECTRICAL CHARACTERISTICS** Unless otherwise specified, all limits are guaranteed for  $T_A = 25^\circ\text{C}$ ,  $V_S = 2.7\text{ V}$ ,  $V_{CM} = V_S/2$ ,  $V_O = V_S/2$  and  $R_L > 1\text{ M}\Omega$ . Typical specifications represent the most likely parametric norm. Min/Max specifications are guaranteed by testing, characterization, or statistical analysis.

Parameter	Symbol	Condition	Min	Typ	Max	Unit
Slew Rate	SR	(Note 6)		0.4		V/ $\mu\text{S}$
Gain Bandwidth Product	GBWP			1.4		MHz
Phase Margin	$\Theta_m$			70		$^\circ$
Gain Margin	Gm			7.5		dB
Input-Referred Voltage Noise	$e_n$	$f = 50\text{ kHz}$ , $V_{CM} = 1.0\text{ V}$		57		nV/ $\sqrt{\text{Hz}}$
Total Harmonic Distortion	THD	$f = 1\text{ kHz}$ , $A_V = +1$ , $R_L = 600\ \Omega$ , $V_O = 1\text{ V}_{PP}$		0.022		%
Amplifier-to-Amplifier Isolation		(Note 7)		123		dB

6. Connected as voltage follower with input step from  $V_{EE}$  to  $V_{CC}$ . Number specified is the slower of the positive and negative slew rates.  
 7. Input referred,  $R_L = 100\text{ k}\Omega$  connected to  $V_S/2$ . Each amp excited in turn with 1 kHz to produce  $V_O = 3\text{ V}_{PP}$ . (For Supply Voltages  $< 3\text{ V}$ ,  $V_O = V_{CC}$ ).

## LMV931, LMV932

**5 V DC ELECTRICAL CHARACTERISTICS** (Note 8) Unless otherwise noted, all min/max limits are guaranteed for  $T_A = 25^\circ\text{C}$ ,  $V_S = 5\text{ V}$ ,  $V_{CM} = V_S/2$ ,  $V_O = V_S/2$  and  $R_L > 1\text{ M}\Omega$ . Typical specifications represent the most likely parametric norm.

Parameter	Symbol	Condition	Min	Typ	Max	Unit
Input Offset Voltage	$V_{IO}$	LMV931 (Single) ( $-40^\circ\text{C}$ to $+125^\circ\text{C}$ )		1	6	mV
		LMV932 (Dual) ( $-40^\circ\text{C}$ to $+125^\circ\text{C}$ )		1	7.5	
Input Offset Voltage Average Drift	$TCV_{IO}$			5.5		$\mu\text{V}/^\circ\text{C}$
Input Bias Current	$I_B$	$-40^\circ\text{C}$ to $+125^\circ\text{C}$		< 1		nA
Input Offset Current	$I_{IO}$	$-40^\circ\text{C}$ to $+125^\circ\text{C}$		< 1		nA
Supply Current (per Channel)	$I_{CC}$	In Active Mode		95	210	$\mu\text{A}$
		$-40^\circ\text{C}$ to $+125^\circ\text{C}$			230	
Common-Mode Rejection Ratio	CMRR	$0\text{ V} \leq V_{CM} \leq 3.8\text{ V}$ , $4.6\text{ V} \leq V_{CM} \leq 5.0\text{ V}$	50	70		dB
		$-40^\circ\text{C}$ to $+125^\circ\text{C}$	50			
		$-0.2\text{ V} \leq V_{CM} \leq 0\text{ V}$ , $5.0\text{ V} \leq V_{CM} \leq 5.2\text{ V}$	50	70		
Power Supply Rejection Ratio	PSRR	$1.8\text{ V} \leq V^+ \leq 5\text{ V}$ , $V_{CM} = 0.5\text{ V}$	50	70		dB
		$-40^\circ\text{C}$ to $+125^\circ\text{C}$	50			
Input Common-Mode Voltage Range	VCM	For CMRR $\geq 50\text{ dB}$ and $T_A = 25^\circ\text{C}$	$V_{EE} - 0.2$	$-0.2$ to $5.3$	$V_{CC} + 0.2$	V
		For CMRR $\geq 50\text{ dB}$ and $T_A = -40^\circ\text{C}$ to $+85^\circ\text{C}$	$V_{EE}$		$V_{CC}$	
		For CMRR $\geq 50\text{ dB}$ and $T_A = -40^\circ\text{C}$ to $+125^\circ\text{C}$	$V_{EE} + 0.3$		$V_{CC} - 0.3$	
Large Signal Voltage Gain LMV931 (Single)	$A_V$	$R_L = 600\ \Omega$ to $2.5\text{ V}$ , $V_O = 0.2\text{ V}$ to $4.8\text{ V}$	88	102		dB
		$-40^\circ\text{C}$ to $+125^\circ\text{C}$	87			
		$R_L = 2\text{ k}\Omega$ to $2.5\text{ V}$ , $V_O = 0.2\text{ V}$ to $4.8\text{ V}$	94	113		
		$-40^\circ\text{C}$ to $+125^\circ\text{C}$	93			
Large Signal Voltage Gain LMV932 (Dual)	$A_V$	$R_L = 600\ \Omega$ to $2.5\text{ V}$ , $V_O = 0.2\text{ V}$ to $4.8\text{ V}$	81	90		dB
		$-40^\circ\text{C}$ to $+125^\circ\text{C}$	78			
		$R_L = 2\text{ k}\Omega$ to $2.5\text{ V}$ , $V_O = 0.2\text{ V}$ to $4.8\text{ V}$	85	100		
		$-40^\circ\text{C}$ to $+125^\circ\text{C}$	82			
Output Swing	$V_{OH}$	$R_L = 600\ \Omega$ to $2.5\text{ V}$ , $V_{IN} = \pm 100\text{ mV}$	4.855	4.89		V
		$-40^\circ\text{C}$ to $+125^\circ\text{C}$	4.835			
	$V_{OL}$	$R_L = 600\ \Omega$ to $2.5\text{ V}$ , $V_{IN} = \pm 100\text{ mV}$		0.12	0.16	
		$-40^\circ\text{C}$ to $+125^\circ\text{C}$			0.18	
	$V_{OH}$	$R_L = 2\text{ k}\Omega$ to $2.5\text{ V}$ , $V_{IN} = \pm 100\text{ mV}$	4.945	4.967		
		$-40^\circ\text{C}$ to $+125^\circ\text{C}$	4.935			
	$V_{OL}$	$R_L = 2\text{ k}\Omega$ to $2.5\text{ V}$ , $V_{IN} = \pm 100\text{ mV}$		0.037	0.065	
		$-40^\circ\text{C}$ to $+125^\circ\text{C}$			0.075	
Output Short-Circuit Current	$I_O$	Sourcing, $V_O = 0\text{ V}$ , $V_{IN} = +100\text{ mV}$	55	65		mA
		$-40^\circ\text{C}$ to $+125^\circ\text{C}$	45			
		Sinking, $V_O = 5\text{ V}$ , $V_{IN} = -100\text{ mV}$	58	80		
		$-40^\circ\text{C}$ to $+125^\circ\text{C}$	45			

8. Guaranteed by design and/or characterization.

## LMV931, LMV932

**5 V AC ELECTRICAL CHARACTERISTICS** Unless otherwise specified, all limits are guaranteed for  $T_A = 25^\circ\text{C}$ ,  $V_S = 5\text{ V}$ ,  $V_{CM} = V_S/2$ ,  $V_O = V_S/2$  and  $R_L > 1\text{ M}\Omega$ . Typical specifications represent the most likely parametric norm.

Parameter	Symbol	Condition	Min	Typ	Max	Unit
Slew Rate	SR	(Note 9)		0.48		V/ $\mu\text{S}$
Gain Bandwidth Product	GBWP			1.5		MHz
Phase Margin	$\Theta_m$			65		$^\circ$
Gain Margin	Gm			8		dB
Input-Referred Voltage Noise	$e_n$	$f = 50\text{ kHz}$ , $V_{CM} = 2\text{ V}$		50		nV/ $\sqrt{\text{Hz}}$
Total Harmonic Distortion	THD	$f = 1\text{ kHz}$ , $A_V = +1$ , $R_L = 600\ \Omega$ , $V_O = 1\text{ V}_{PP}$		0.022		%
Amplifier-to-Amplifier Isolation		(Note 10)		123		dB

9. Connected as voltage follower with input step from  $V_{EE}$  to  $V_{CC}$ . Number specified is the slower of the positive and negative slew rates.

10. Input referred,  $R_L = 100\text{ k}\Omega$  connected to  $V_S/2$ . Each amp excited in turn with 1 kHz to produce  $V_O = 3\text{ V}_{PP}$ . (For Supply Voltages  $< 3\text{ V}$ ,  $V_O = V_{CC}$ ).



# LMV931, LMV932

## TYPICAL CHARACTERISTICS

( $T_A = 25^\circ\text{C}$  and  $V_S = 5\text{ V}$  unless otherwise specified)

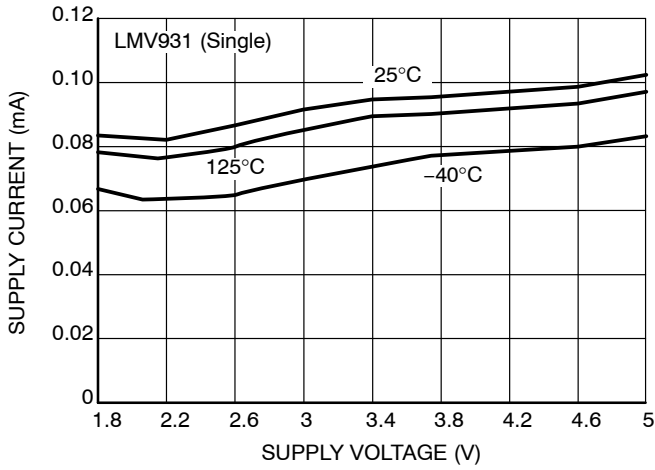

Figure 2. Supply Current vs. Supply Voltage

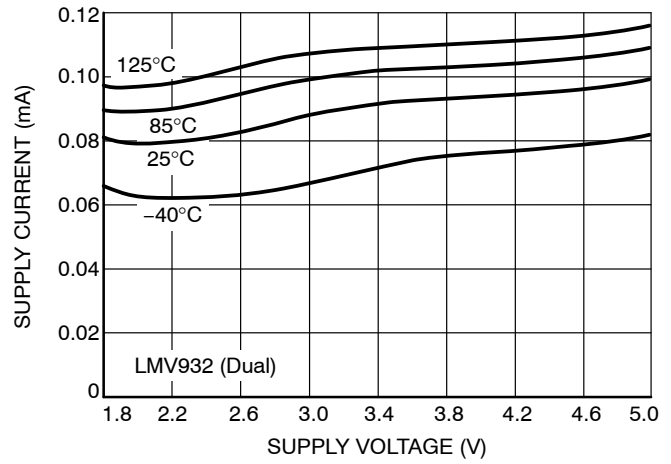

Figure 3. Supply Current vs. Supply Voltage

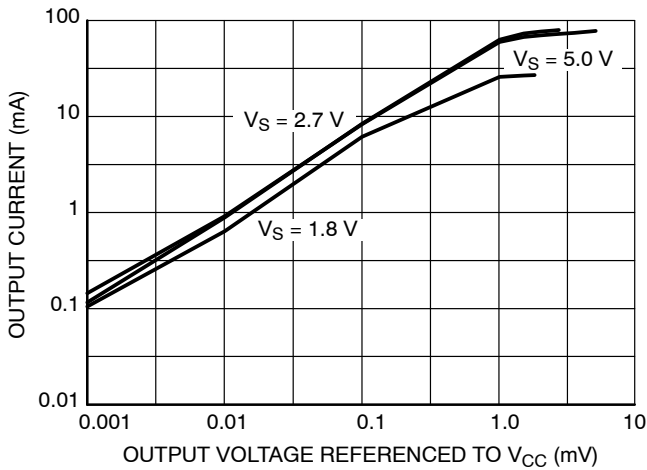

Figure 4. Sourcing Current vs. Output Voltage  
( $T_A = 25^\circ\text{C}$ )

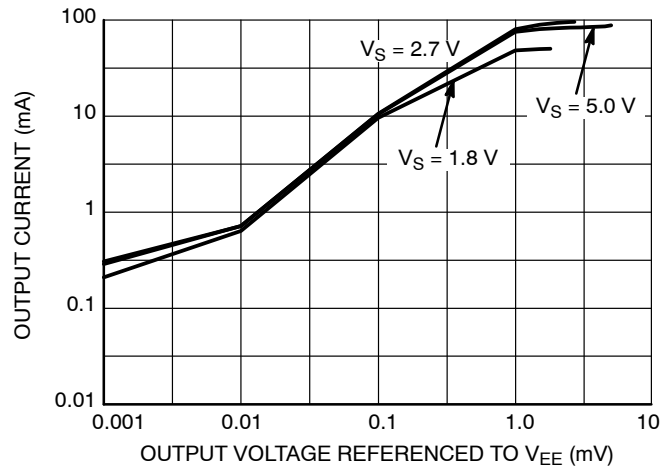

Figure 5. Sinking Current vs. Output Voltage  
( $T_A = 25^\circ\text{C}$ )

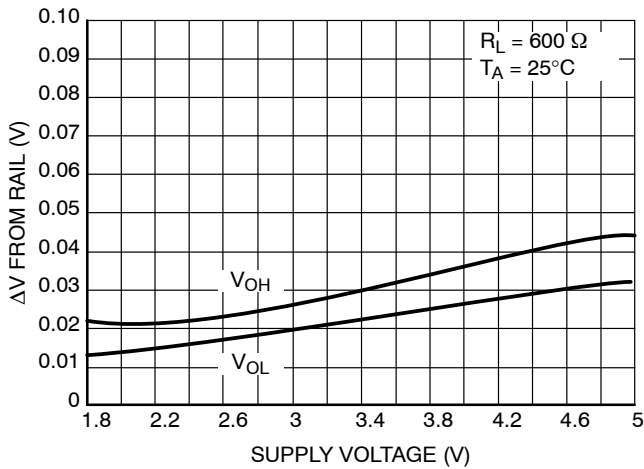

Figure 6. Output Voltage Swing vs. Supply Voltage

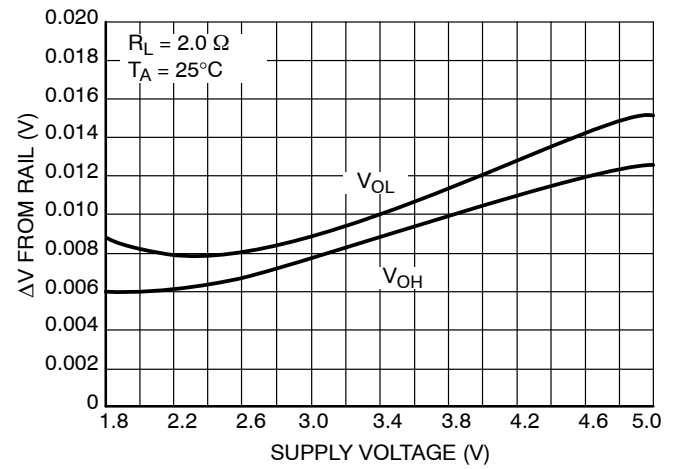

Figure 7. Output Voltage vs. Supply Voltage

# LMV931, LMV932

## TYPICAL CHARACTERISTICS

( $T_A = 25^\circ\text{C}$  and  $V_S = 5\text{ V}$  unless otherwise specified)

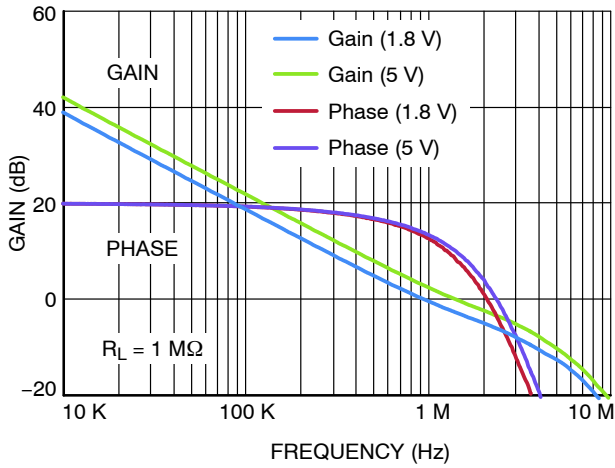

Figure 8. Open Loop Gain and Phase

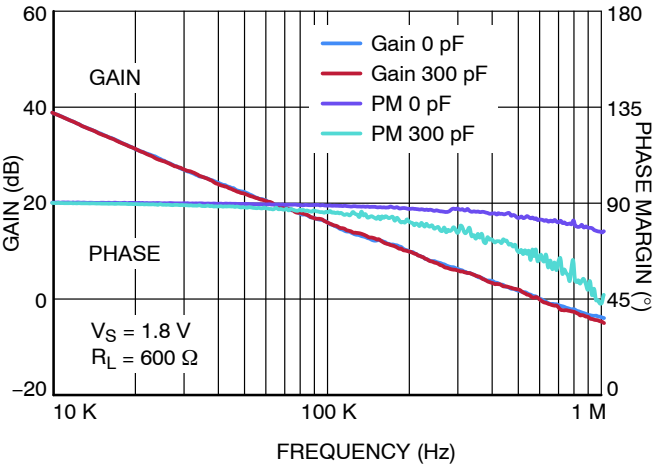

Figure 9. Frequency Response vs. CL

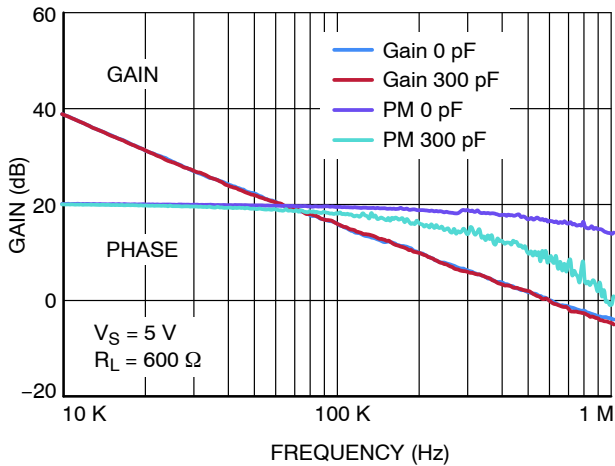

Figure 10. Frequency Response vs. CL

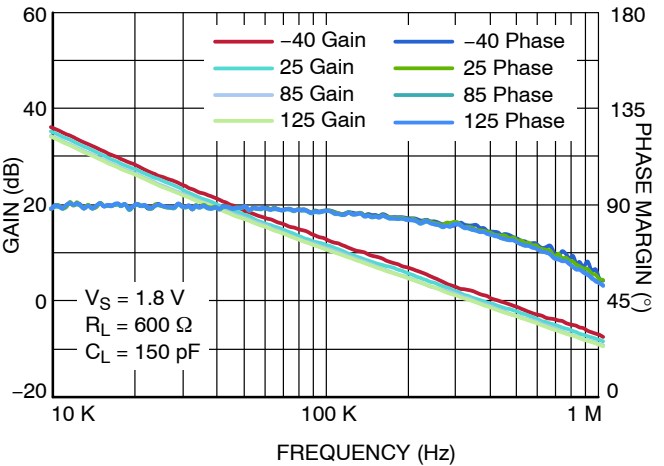

Figure 11. Gain and Phase vs. Temp

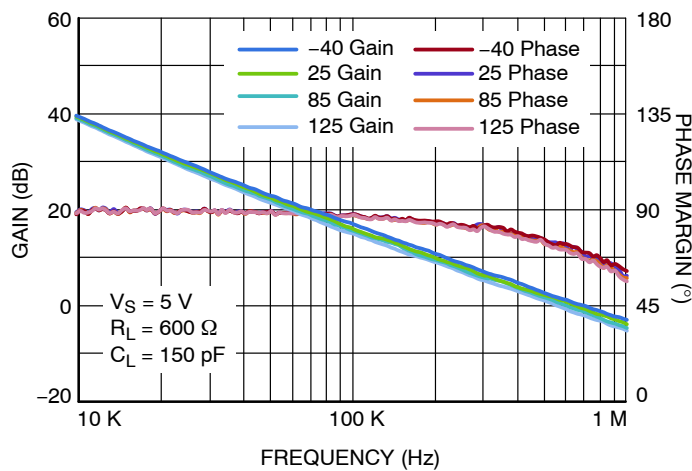

Figure 12. Gain and Phase vs. Temp

# LMV931, LMV932

## TYPICAL CHARACTERISTICS

( $T_A = 25^\circ\text{C}$  and  $V_S = 5\text{ V}$  unless otherwise specified)

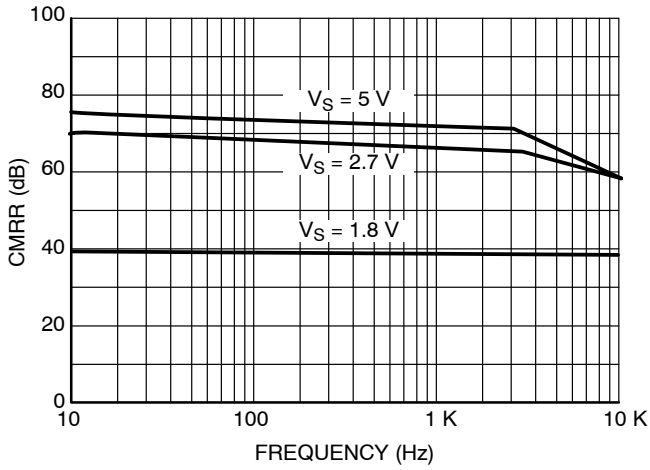

Figure 13. CMRR vs. Frequency

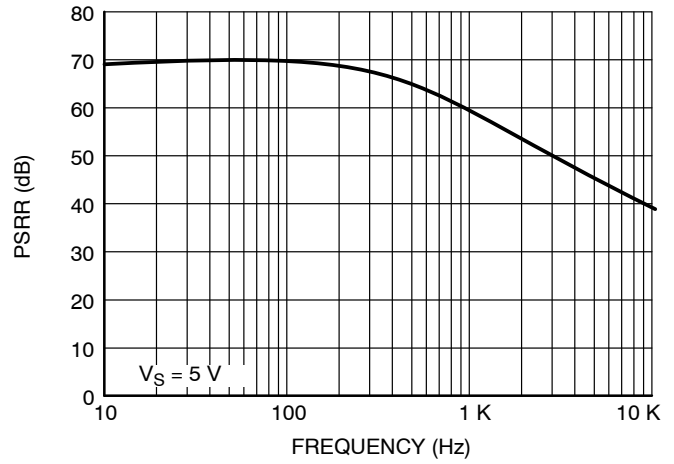

Figure 14. PSRR vs. Frequency

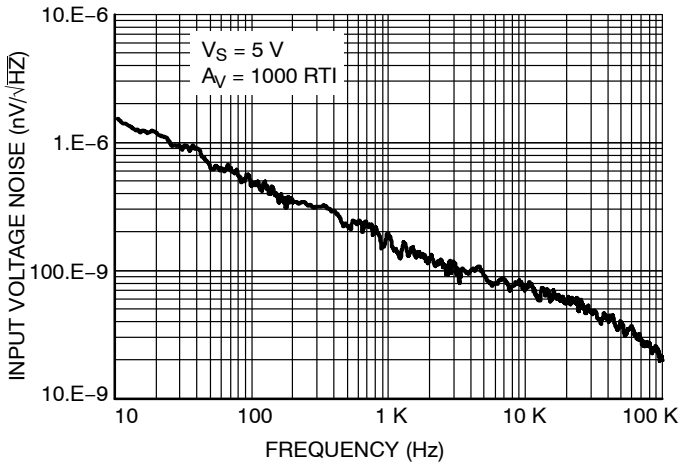

Figure 15. Input Voltage Noise vs. Frequency

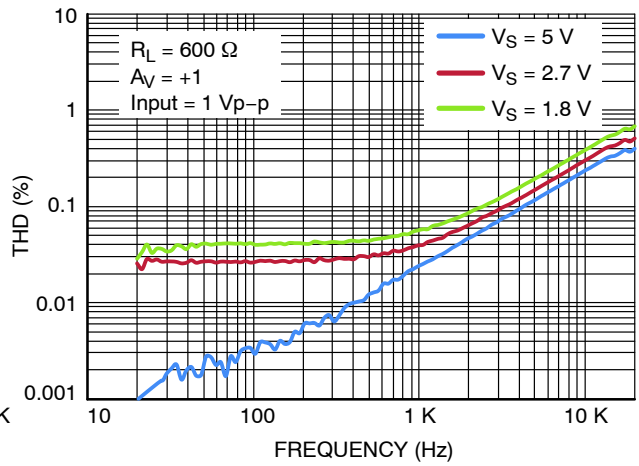

Figure 16. THD vs. Frequency

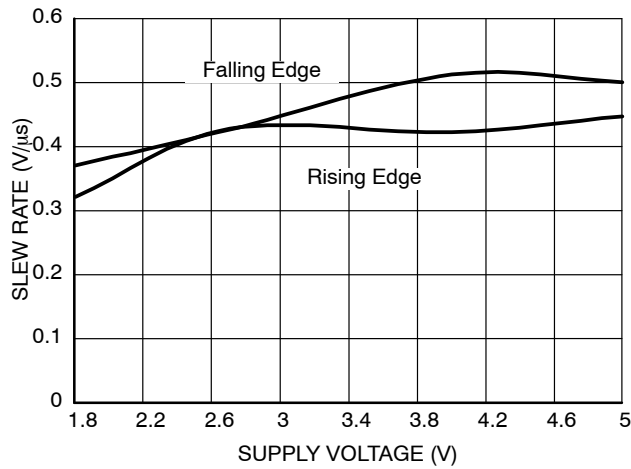

Figure 17. Slew Rate vs. Supply Voltage

# LMV931, LMV932

## TYPICAL CHARACTERISTICS

( $T_A = 25^\circ\text{C}$  and  $V_S = 5\text{ V}$  unless otherwise specified)

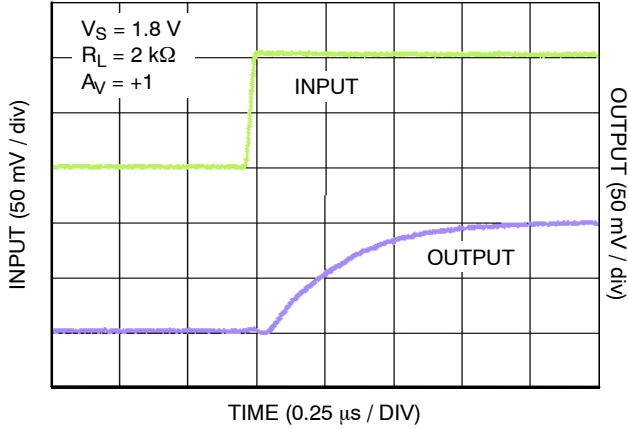

Figure 18. Small Signal Transient Response

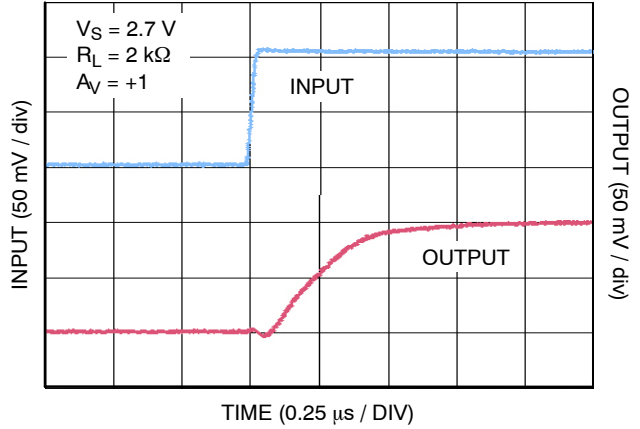

Figure 19. Small Signal Transient Response

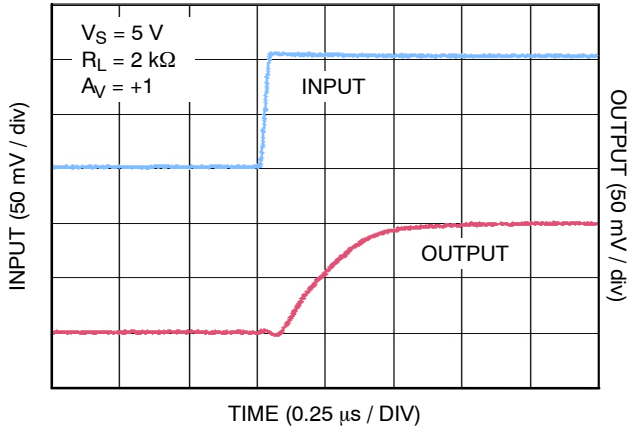

Figure 20. Small Signal Transient Response

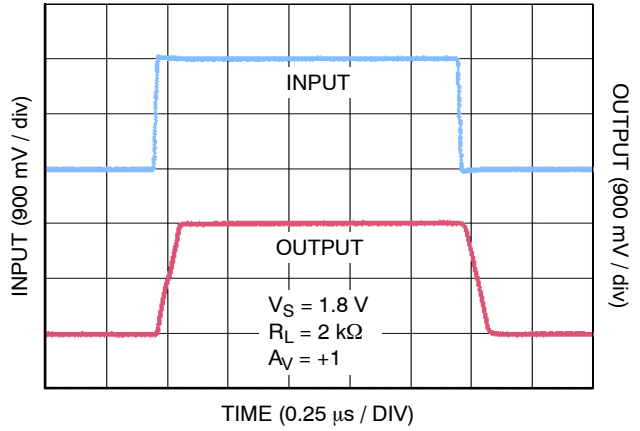

Figure 21. Large Signal Transient Response

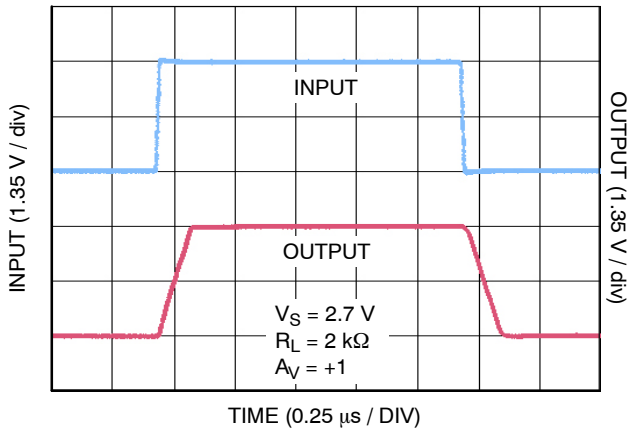

Figure 22. Large Signal Transient Response

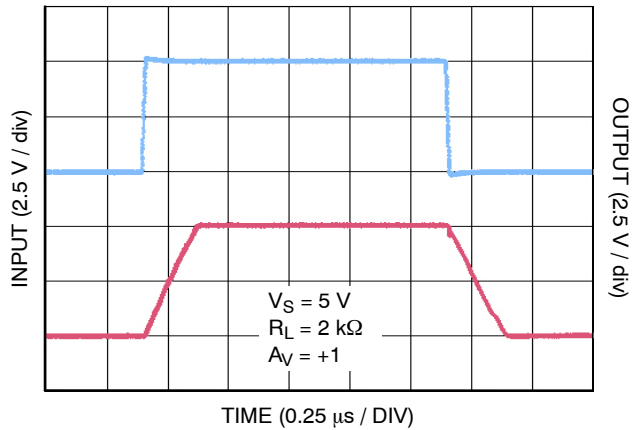
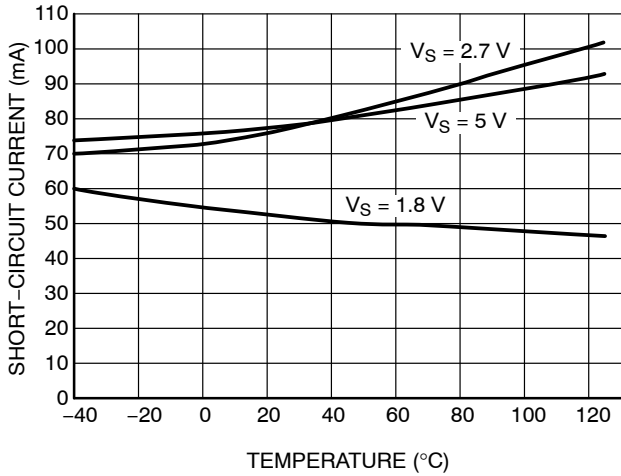

Figure 23. Large Signal Transient Response

# LMV931, LMV932

## TYPICAL CHARACTERISTICS

( $T_A = 25^\circ\text{C}$  and  $V_S = 5\text{ V}$  unless otherwise specified)



**Figure 24. Short-Circuit vs. Temperature (Sinking)**

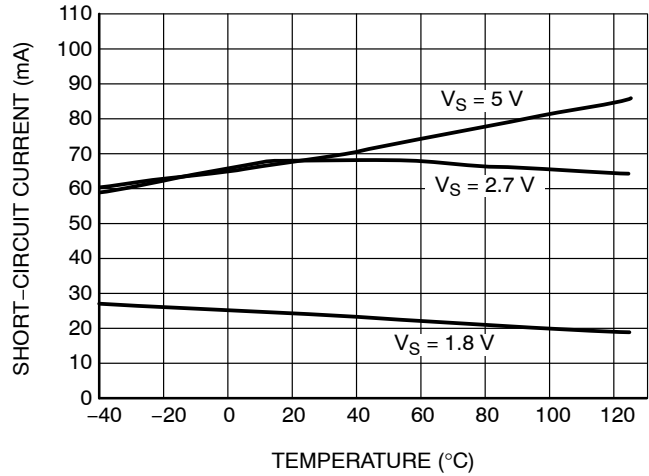

**Figure 25. Short-Circuit vs. Temperature (Sourcing)**

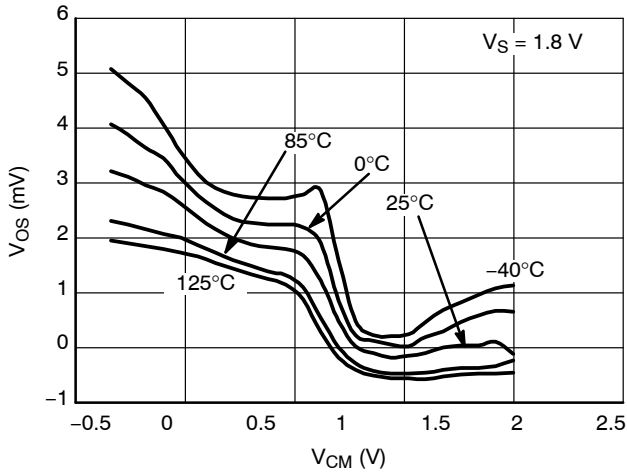

**Figure 26. Offset Voltage vs. Common Mode Range  $V_{DD}$**

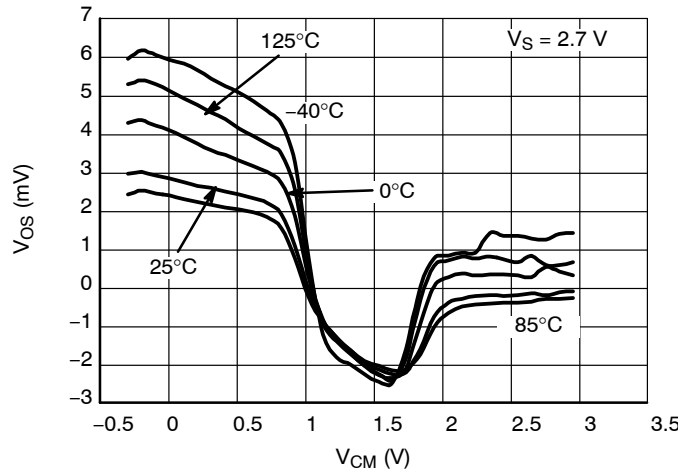

**Figure 27. Offset Voltage vs. Common Mode Range**

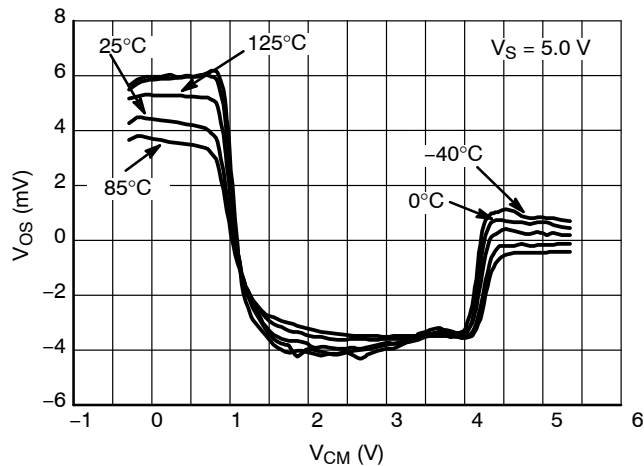

**Figure 28. Offset Voltage vs. Common Mode Range**

# LMV931, LMV932

## APPLICATION INFORMATION

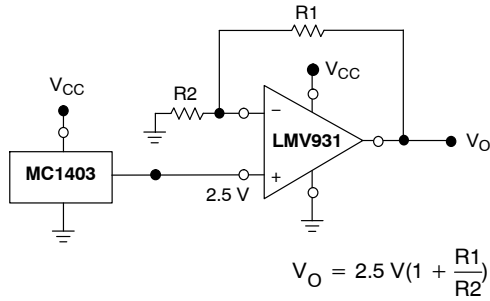

Figure 29. Voltage Reference

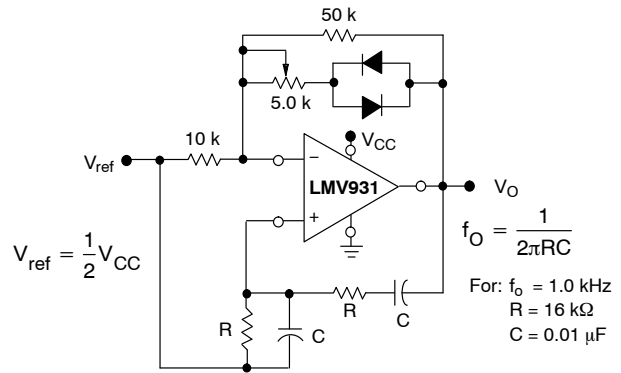

Figure 30. Wien Bridge Oscillator

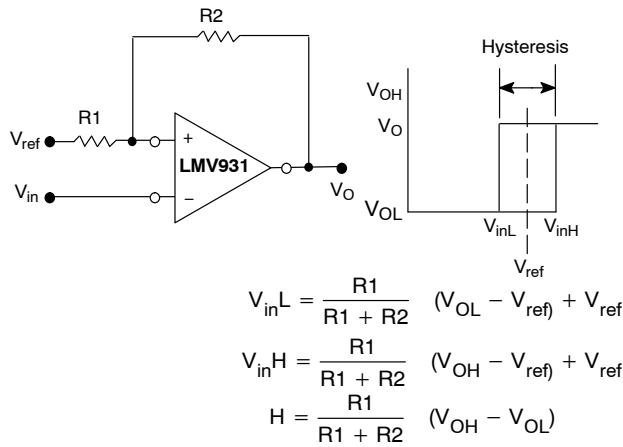
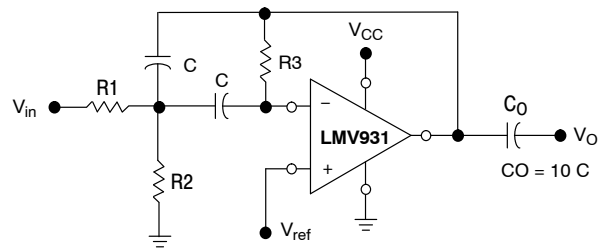

Figure 31. Comparator with Hysteresis



Given:  $f_o$  = center frequency  
 $A(f_o)$  = gain at center frequency

Choose value  $f_o, C$   
 Then:  $R3 = \frac{Q}{\pi f_o C}$   
 $R1 = \frac{R3}{2 A(f_o)}$   
 $R2 = \frac{R1 R3}{4Q^2 R1 - R3}$

For less than 10% error from operational amplifier,  
 $((Q_o f_o)/BW) < 0.1$  where  $f_o$  and  $BW$  are expressed in Hz.  
 If source impedance varies, filter may be preceded with  
 voltage follower buffer to stabilize filter parameters.

Figure 32. Multiple Feedback Bandpass Filter

## ORDERING INFORMATION

Order Number	Number of Channels	Number of Pins	Package Type	Shipping <sup>†</sup>
LMV931SQ3T2G	Single	5	SC70-5 (Pb-Free)	3000 / Tape & Reel
LMV931SN3T1G	Single	5	TSOP-5 (Pb-Free)	3000 / Tape & Reel
LMV932DMR2G	Dual	8	Micro8 (Pb-Free)	4000 / Tape & Reel
LMV932DR2G	Dual	8	SOIC-8 (Pb-Free)	2500 / Tape & Reel

<sup>†</sup>For information on tape and reel specifications, including part orientation and tape sizes, please refer to our Tape and Reel Packaging Specifications Brochure, BRD8011/D.

# MECHANICAL CASE OUTLINE PACKAGE DIMENSIONS

ON Semiconductor®



SCALE 2:1

SC-88A (SC-70-5/SOT-353)  
CASE 419A-02  
ISSUE L

DATE 17 JAN 2013

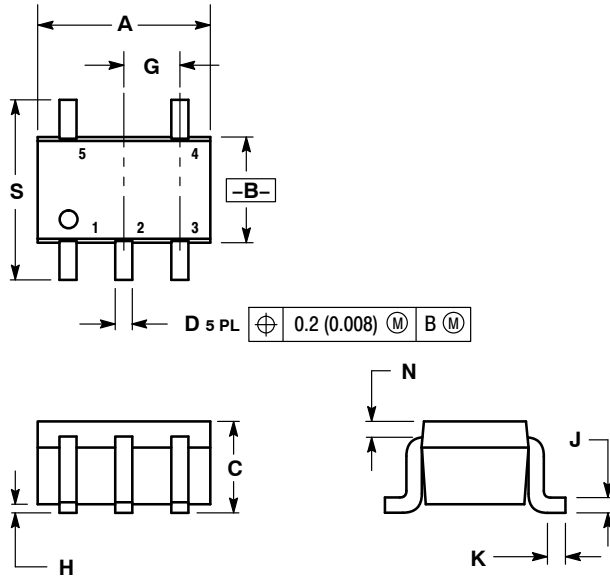

### SOLDER FOOTPRINT

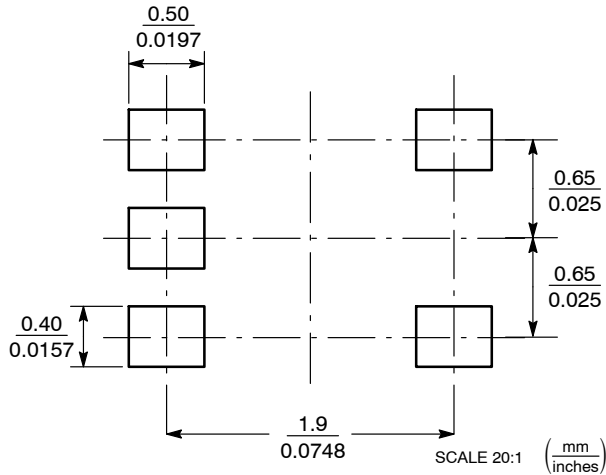

### NOTES:

1. DIMENSIONING AND TOLERANCING PER ANSI Y14.5M, 1982.
2. CONTROLLING DIMENSION: INCH.
3. 419A-01 OBSOLETE. NEW STANDARD 419A-02.
4. DIMENSIONS A AND B DO NOT INCLUDE MOLD FLASH, PROTRUSIONS, OR GATE BURRS.

DIM	INCHES		MILLIMETERS	
	MIN	MAX	MIN	MAX
A	0.071	0.087	1.80	2.20
B	0.045	0.053	1.15	1.35
C	0.031	0.043	0.80	1.10
D	0.004	0.012	0.10	0.30
G	0.026 BSC		0.65 BSC	
H	---	0.004	---	0.10
J	0.004	0.010	0.10	0.25
K	0.004	0.012	0.10	0.30
N	0.008 REF		0.20 REF	
S	0.079	0.087	2.00	2.20

### GENERIC MARKING DIAGRAM\*

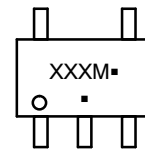

- XXX = Specific Device Code
- M = Date Code
- = Pb-Free Package

(Note: Microdot may be in either location)

\*This information is generic. Please refer to device data sheet for actual part marking. Pb-Free indicator, "G" or microdot "▪", may or may not be present. Some products may not follow the Generic Marking.

#### STYLE 1:

- PIN 1. BASE
- 2. EMITTER
- 3. BASE
- 4. COLLECTOR
- 5. COLLECTOR

#### STYLE 2:

- PIN 1. ANODE
- 2. EMITTER
- 3. BASE
- 4. COLLECTOR
- 5. CATHODE

#### STYLE 3:

- PIN 1. ANODE 1
- 2. N/C
- 3. ANODE 2
- 4. CATHODE 2
- 5. CATHODE 1

#### STYLE 4:

- PIN 1. SOURCE 1
- 2. DRAIN 1/2
- 3. SOURCE 2
- 4. GATE 1
- 5. GATE 2

#### STYLE 5:

- PIN 1. CATHODE
- 2. COMMON ANODE
- 3. CATHODE 2
- 4. CATHODE 3
- 5. CATHODE 4

#### STYLE 6:

- PIN 1. EMITTER 2
- 2. BASE 2
- 3. EMITTER 1
- 4. COLLECTOR
- 5. COLLECTOR 2/BASE 1

#### STYLE 7:

- PIN 1. BASE
- 2. EMITTER
- 3. BASE
- 4. COLLECTOR
- 5. COLLECTOR

#### STYLE 8:

- PIN 1. CATHODE
- 2. COLLECTOR
- 3. N/C
- 4. BASE
- 5. EMITTER

#### STYLE 9:

- PIN 1. ANODE
- 2. CATHODE
- 3. ANODE
- 4. ANODE
- 5. ANODE

Note: Please refer to datasheet for style callout. If style type is not called out in the datasheet refer to the device datasheet pinout or pin assignment.

# MECHANICAL CASE OUTLINE

## PACKAGE DIMENSIONS



SCALE 2:1

**TSOP-5**  
CASE 483  
ISSUE N

DATE 12 AUG 2020

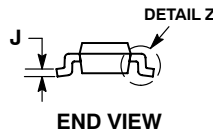
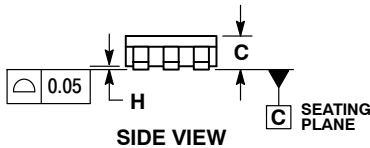
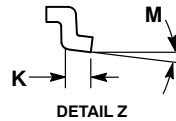
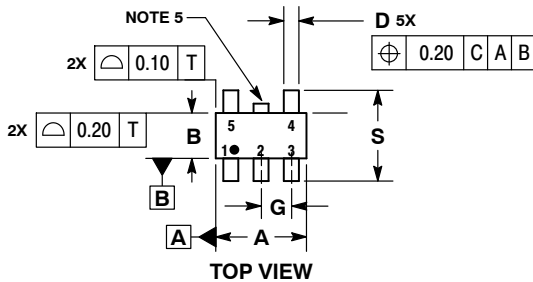

**NOTES:**

1. DIMENSIONING AND TOLERANCING PER ASME Y14.5M, 1994.
2. CONTROLLING DIMENSION: MILLIMETERS.
3. MAXIMUM LEAD THICKNESS INCLUDES LEAD FINISH THICKNESS. MINIMUM LEAD THICKNESS IS THE MINIMUM THICKNESS OF BASE MATERIAL.
4. DIMENSIONS A AND B DO NOT INCLUDE MOLD FLASH, PROTRUSIONS, OR GATE BURRS. MOLD FLASH, PROTRUSIONS, OR GATE BURRS SHALL NOT EXCEED 0.15 PER SIDE. DIMENSION A.
5. OPTIONAL CONSTRUCTION: AN ADDITIONAL TRIMMED LEAD IS ALLOWED IN THIS LOCATION. TRIMMED LEAD NOT TO EXTEND MORE THAN 0.2 FROM BODY.

MILLIMETERS		
DIM	MIN	MAX
A	2.85	3.15
B	1.35	1.65
C	0.90	1.10
D	0.25	0.50
G	0.95 BSC	
H	0.01	0.10
J	0.10	0.26
K	0.20	0.60
M	0°	10°
S	2.50	3.00

**SOLDERING FOOTPRINT\***

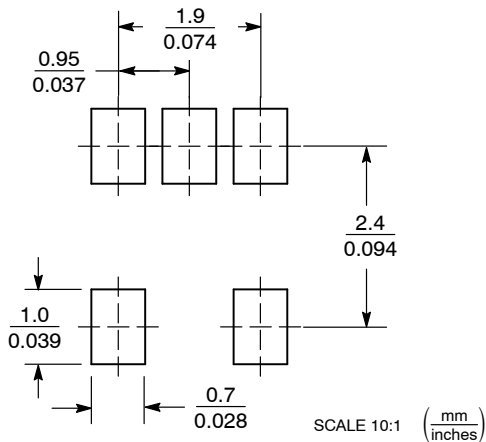

\*For additional information on our Pb-Free strategy and soldering details, please download the ON Semiconductor Soldering and Mounting Techniques Reference Manual, SOLDERRM/D.

**GENERIC MARKING DIAGRAM\***

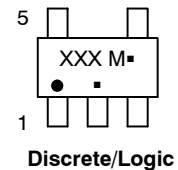
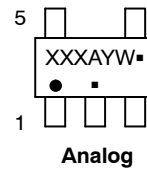

- XXX = Specific Device Code    XXX = Specific Device Code  
 A = Assembly Location        M = Date Code  
 Y = Year                        ■ = Pb-Free Package  
 W = Work Week  
 ■ = Pb-Free Package

(Note: Microdot may be in either location)

\*This information is generic. Please refer to device data sheet for actual part marking. Pb-Free indicator, "G" or microdot "■", may or may not be present.



# MECHANICAL CASE OUTLINE

## PACKAGE DIMENSIONS

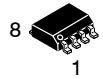

SCALE 1:1

**SOIC-8 NB**  
CASE 751-07  
ISSUE AK

DATE 16 FEB 2011

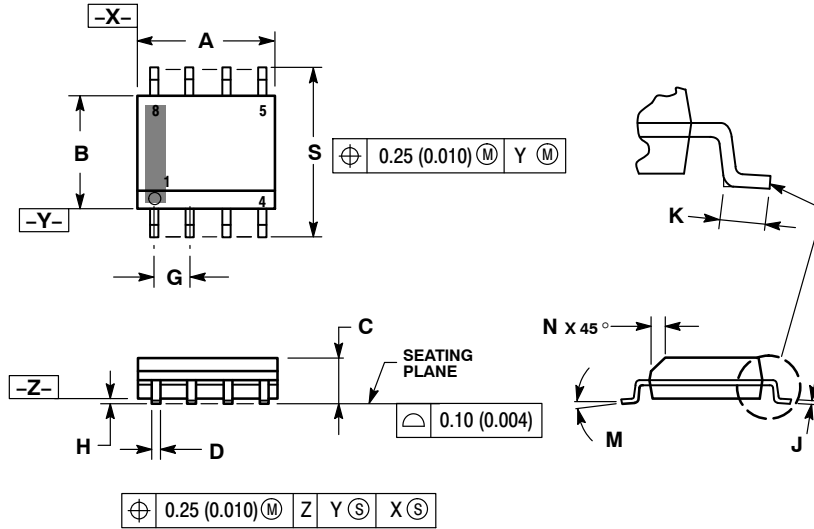

- NOTES:
1. DIMENSIONING AND TOLERANCING PER ANSI Y14.5M, 1982.
  2. CONTROLLING DIMENSION: MILLIMETER.
  3. DIMENSION A AND B DO NOT INCLUDE MOLD PROTRUSION.
  4. MAXIMUM MOLD PROTRUSION 0.15 (0.006) PER SIDE.
  5. DIMENSION D DOES NOT INCLUDE DAMBAR PROTRUSION. ALLOWABLE DAMBAR PROTRUSION SHALL BE 0.127 (0.005) TOTAL IN EXCESS OF THE D DIMENSION AT MAXIMUM MATERIAL CONDITION.
  6. 751-01 THRU 751-06 ARE OBSOLETE. NEW STANDARD IS 751-07.

DIM	MILLIMETERS		INCHES	
	MIN	MAX	MIN	MAX
A	4.80	5.00	0.189	0.197
B	3.80	4.00	0.150	0.157
C	1.35	1.75	0.053	0.069
D	0.33	0.51	0.013	0.020
G	1.27 BSC		0.050 BSC	
H	0.10	0.25	0.004	0.010
J	0.19	0.25	0.007	0.010
K	0.40	1.27	0.016	0.050
M	0°	8°	0°	8°
N	0.25	0.50	0.010	0.020
S	5.80	6.20	0.228	0.244

### GENERIC MARKING DIAGRAM\*

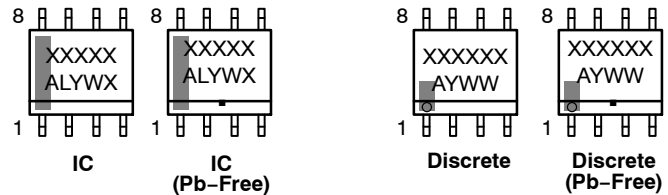
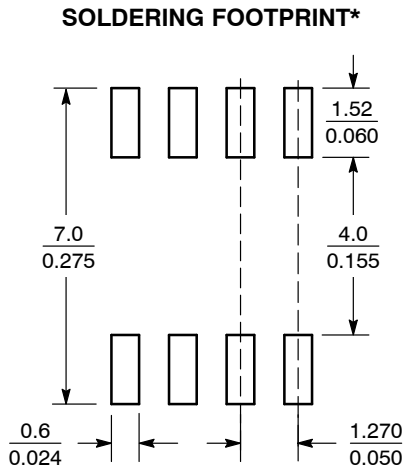

XXXXXX = Specific Device Code  
A = Assembly Location  
L = Wafer Lot  
Y = Year  
W = Work Week  
■ = Pb-Free Package

XXXXXX = Specific Device Code  
A = Assembly Location  
Y = Year  
WW = Work Week  
■ = Pb-Free Package

\*This information is generic. Please refer to device data sheet for actual part marking. Pb-Free indicator, "G" or microdot "•", may or may not be present. Some products may not follow the Generic Marking.

\*For additional information on our Pb-Free strategy and soldering details, please download the ON Semiconductor Soldering and Mounting Techniques Reference Manual, SOLDERRM/D.

STYLES ON PAGE 2

SCALE 6:1 (mm/inches)

# MECHANICAL CASE OUTLINE

## PACKAGE DIMENSIONS



SCALE 2:1

**Micro8**  
CASE 846A-02  
ISSUE K

DATE 16 JUL 2020

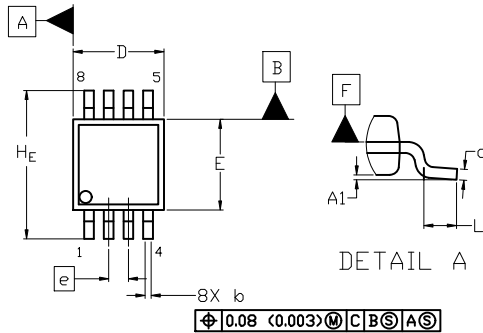

TOP VIEW

NOTE 3

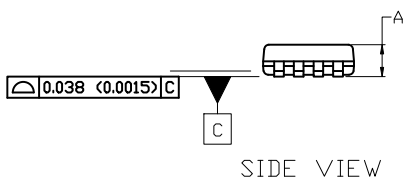

SIDE VIEW

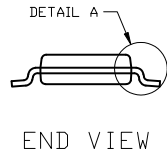

END VIEW

**NOTES:**

1. DIMENSIONING AND TOLERANCING PER ASME Y14.5M, 2009.
2. CONTROLLING DIMENSION: MILLIMETERS
3. DIMENSION *b* DOES NOT INCLUDE DAMBAR PROTRUSION. ALLOWABLE PROTRUSION SHALL BE 0.10 mm IN EXCESS OF MAXIMUM MATERIAL CONDITION.
4. DIMENSIONS D AND E DO NOT INCLUDE MOLD FLASH, PROTRUSION OR GATE BURRS. MOLD FLASH, PROTRUSIONS, OR GATE BURRS SHALL NOT EXCEED 0.15 mm PER SIDE. DIMENSION E DOES NOT INCLUDE INTERLEAD FLASH OR PROTRUSION. INTERLEAD FLASH OR PROTRUSION SHALL NOT EXCEED 0.25 mm PER SIDE. DIMENSIONS D AND E ARE DETERMINED AT DATUM F.
5. DATUMS A AND B ARE TO BE DETERMINED AT DATUM F.
6. A1 IS DEFINED AS THE VERTICAL DISTANCE FROM THE SEATING PLANE TO THE LOWEST POINT ON THE PACKAGE BODY.

$\phi 0.08$  (0.003) M C B S A S

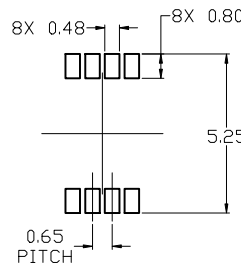

RECOMMENDED MOUNTING FOOTPRINT

DIM	MILLIMETERS		
	MIN.	NOM.	MAX.
A	---	---	1.10
A1	0.05	0.08	0.15
<i>b</i>	0.25	0.33	0.40
<i>c</i>	0.13	0.18	0.23
D	2.90	3.00	3.10
E	2.90	3.00	3.10
<i>e</i>	0.65 BSC		
HE	4.75	4.90	5.05
L	0.40	0.55	0.70

For additional information on our Pb-Free strategy and soldering details, please download the [DN Semiconductor Soldering and Mounting Techniques Reference Manual, SOLDERM/D](#).

**GENERIC MARKING DIAGRAM\***

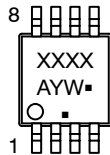

- XXXX = Specific Device Code
- A = Assembly Location
- Y = Year
- W = Work Week
- = Pb-Free Package

(Note: Microdot may be in either location)

\*This information is generic. Please refer to device data sheet for actual part marking. Pb-Free indicator, "G" or microdot "▪", may or may not be present. Some products may not follow the Generic Marking.

**STYLE 1:**

1. SOURCE
2. SOURCE
3. SOURCE
4. GATE
5. DRAIN
6. DRAIN
7. DRAIN
8. DRAIN

**STYLE 2:**

1. SOURCE 1
2. GATE 1
3. SOURCE 2
4. GATE 2
5. DRAIN 2
6. DRAIN 2
7. DRAIN 1
8. DRAIN 1

**STYLE 3:**

1. N-SOURCE
2. N-GATE
3. P-SOURCE
4. P-GATE
5. P-DRAIN
6. P-DRAIN
7. N-DRAIN
8. N-DRAIN