

SGM8251

2.8MHz, High Voltage, High Precision, Low Noise Rail-to-Rail Output Operational Amplifier

GENERAL DESCRIPTION

The single SGM8251 is a rail-to-rail output, low noise and high precision operational amplifier which has low input offset voltage and bias current. It is guaranteed to operate from 4.5V to 36V single supply.

The rail-to-rail output swing provided by the SGM8251 makes both high-side and low-side sensing easy. The combination of these characteristics makes the SGM8251 a good choice for temperature, position and pressure sensors, medical equipment and strain gauge amplifiers, or any other 4.5V to 36V applications requiring precision and long term stability.

The single SGM8251 is available in Green SOT-23-5, SOIC-8 and MSOP-8 packages. It is rated over the -40°C to +125°C temperature range.

APPLICATIONS

- Temperature Measurements
- Pressure Sensors
- Precision Current Sensing
- Electronic Scales
- Strain Gauge Amplifiers
- Medical Instrumentation
- Thermocouple Amplifiers
- Handheld Test Equipment

FEATURES

- **Low Offset Voltage:** 18 μ V (MAX)
- **Rail-to-Rail Output Swing**
- **4.5V to 36V Single Supply Operation**
- **Open-Loop Voltage Gain:** 150dB (TYP)
- **PSRR:** 150dB (TYP)
- **CMRR:** 135dB (TYP)
- **0.1Hz to 10Hz Noise:** 0.4 μ V_{P-P}
- **Input Voltage Noise Density:** 20nV/ $\sqrt{\text{Hz}}$ at 1kHz
- **Gain-Bandwidth Product:** 2.8MHz
- **Low Supply Current:** 450 μ A (TYP)
- **Overload Recovery Time:** 3 μ s
- **-40°C to +125°C Operating Temperature Range**
- **Available in Green SOT-23-5, SOIC-8 and MSOP-8 Packages**

PIN CONFIGURATIONS

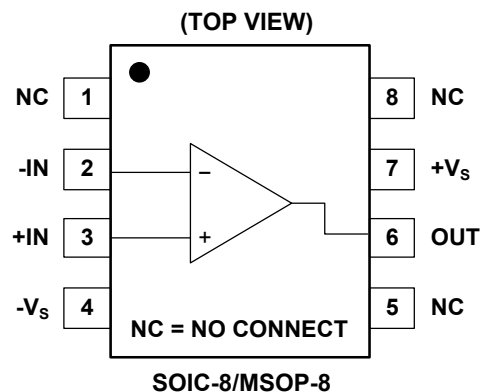
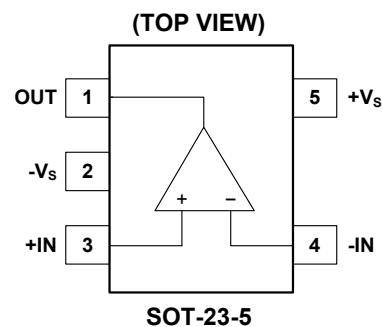

2.8MHz, High Voltage, High Precision, Low Noise SGM8251 Rail-to-Rail Output Operational Amplifier

PACKAGE/ORDERING INFORMATION

MODEL	PACKAGE DESCRIPTION	SPECIFIED TEMPERATURE RANGE	ORDERING NUMBER	PACKAGE MARKING	PACKING OPTION
SGM8251	SOT-23-5	-40°C to +125°C	SGM8251XN5G/TR	ST3XX	Tape and Reel, 3000
	SOIC-8	-40°C to +125°C	SGM8251XS8G/TR	SGM 8251XS8 XXXXX	Tape and Reel, 2500
	MSOP-8	-40°C to +125°C	SGM8251XMS8G/TR	SGM8251 XMS8 XXXXX	Tape and Reel, 4000

MARKING INFORMATION

NOTE: XX = Date Code. XXXXX = Date Code and Vendor Code.

SOT-23-5

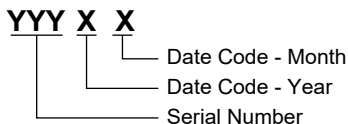

SOIC-8/MSOP-8

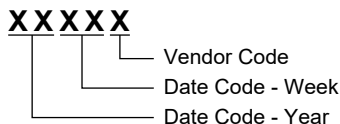

Green (RoHS & HSF): SG Micro Corp defines "Green" to mean Pb-Free (RoHS compatible) and free of halogen substances. If you have additional comments or questions, please contact your SGMICRO representative directly.

ABSOLUTE MAXIMUM RATINGS

Supply Voltage.....	40V
Input Voltage Range.....	(-V _S) - 0.3V to (+V _S) + 0.3V
Differential Input Voltage Range.....	-5V to 5V
Junction Temperature.....	+150°C
Storage Temperature Range.....	-65°C to +150°C
Lead Temperature (Soldering, 10s).....	+260°C
ESD Susceptibility	
HBM.....	6000V
MM.....	300V
CDM.....	1000V

RECOMMENDED OPERATING CONDITIONS

Operating Voltage Range.....	4.5V to 36V
Operating Temperature Range.....	-40°C to +125°C
Differential Input Voltage Range.....	-0.7V to 0.7V

OVERSTRESS CAUTION

Stresses beyond those listed in Absolute Maximum Ratings may cause permanent damage to the device. Exposure to absolute maximum rating conditions for extended periods may affect reliability. Functional operation of the device at any conditions beyond those indicated in the Recommended Operating Conditions section is not implied.

ESD SENSITIVITY CAUTION

This integrated circuit can be damaged by ESD if you don't pay attention to ESD protection. SGMICRO recommends that all integrated circuits be handled with appropriate precautions. Failure to observe proper handling and installation procedures can cause damage. ESD damage can range from subtle performance degradation to complete device failure. Precision integrated circuits may be more susceptible to damage because very small parametric changes could cause the device not to meet its published specifications.

DISCLAIMER

SG Micro Corp reserves the right to make any change in circuit design, or specifications without prior notice.

ELECTRICAL CHARACTERISTICS

(At $T_A = +25^\circ\text{C}$, $V_S = \pm 2.5\text{V}$ to $V_S = \pm 18\text{V}$, $V_{CM} = 0\text{V}$ and $R_L = 10\text{k}\Omega$ connected to 0V , Full = -40°C to $+125^\circ\text{C}$, unless otherwise noted.)

PARAMETER	CONDITIONS	TEMP	MIN	TYP	MAX	UNITS
Input Characteristics						
Input Offset Voltage (V_{OS})		+25°C		5	18	μV
		Full			20	
Input Offset Voltage Drift ($\Delta V_{OS}/\Delta T$)		Full		20		$\text{nV}/^\circ\text{C}$
Input Bias Current (I_B)		+25°C		± 100	± 400	pA
Input Offset Current (I_{OS})		+25°C		± 200	± 600	pA
Input Common Mode Voltage Range (V_{CM})		Full	$(-V_S) - 0.05$		$(+V_S) - 1.5$	V
Common Mode Rejection Ratio ⁽¹⁾ (CMRR)	$V_{CM} = (-V_S) - 0.05\text{V}$ to $(+V_S) - 1.5\text{V}$	+25°C	115	135		dB
		Full	112			
Open-Loop Voltage Gain (A_{OL})	$V_S = \pm 2.5\text{V}$, $V_{OUT} = \pm 2.0\text{V}$	+25°C	118	140		dB
		Full	115			
	$V_S = \pm 18\text{V}$, $V_{OUT} = \pm 17.5\text{V}$	+25°C	128	150		
		Full	125			
Output Characteristics						
Output Voltage Swing from Rail	$V_S = \pm 2.5\text{V}$	+25°C		12	25	mV
		Full			30	
	$V_S = \pm 18\text{V}$	+25°C		95	140	
		Full			200	
Output Short-Circuit Current (I_{SC})	$V_S = \pm 2.5\text{V}$	+25°C	± 20	± 32		mA
		Full	± 11			
	$V_S = \pm 18\text{V}$	+25°C	± 38	± 50		
		Full	± 18			
Power Supply						
Operating Voltage Range (V_S)		Full	4.5		36	V
Quiescent Current (I_Q)	$I_{OUT} = 0$	+25°C		450	660	μA
		Full			750	
Power Supply Rejection Ratio ⁽¹⁾ (PSRR)	$V_S = 4.5\text{V}$ to 36V	+25°C	128	150		dB
		Full	125			
Dynamic Performance						
Gain-Bandwidth Product (GBP)	$V_{OUT} = 100\text{mV}_{P-P}$, $C_L = 10\text{pF}$	+25°C		2.8		MHz
Slew Rate (SR)		+25°C		1.3		$\text{V}/\mu\text{s}$
Settling Time to 0.1% (t_s)	$V_{IN} = 1\text{V}$ Step, $A_V = +1$	+25°C		0.8		μs
Overload Recovery Time	$V_{IN} \times A_V > V_S$	+25°C		3		μs
Total Harmonic Distortion + Noise (THD+N)	$V_{IN} = 2\text{V}_{P-P}$, $A_V = +1$, $f = 1\text{kHz}$	+25°C		0.0002		%
Noise						
Input Voltage Noise	$f = 0.1\text{Hz}$ to 10Hz	+25°C		0.4		μV_{P-P}
Input Voltage Noise Density (e_n)	$f = 0.1\text{kHz}$	+25°C		20		$\text{nV}/\sqrt{\text{Hz}}$
	$f = 1\text{kHz}$	+25°C		20		
	$f = 10\text{kHz}$	+25°C		23		

NOTE: 1. PSRR and CMRR are affected by the matching between external gain-setting resistor ratios.

TYPICAL PERFORMANCE CHARACTERISTICS

At $T_A = +25^\circ\text{C}$, $V_S = \pm 15\text{V}$, $C_L = 10\text{pF}$ and $R_L = 10\text{k}\Omega$, unless otherwise noted.

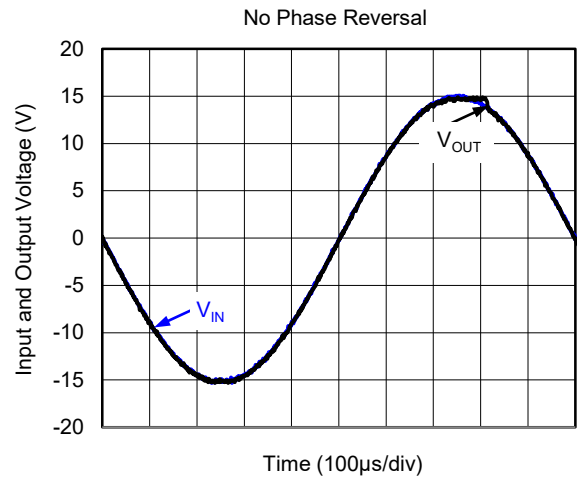
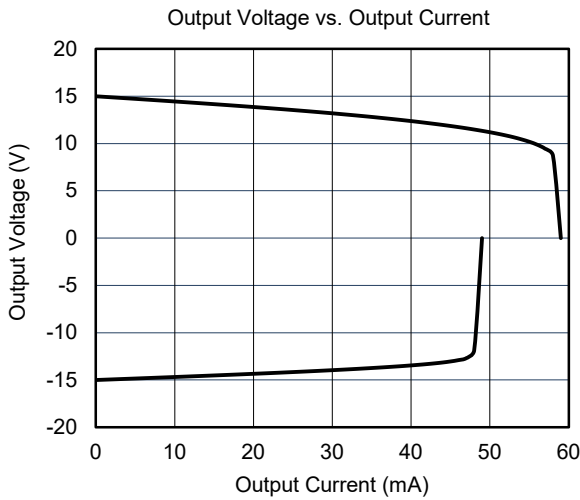
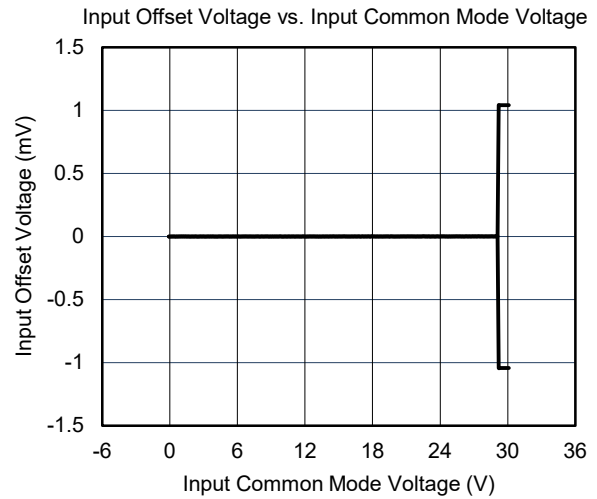
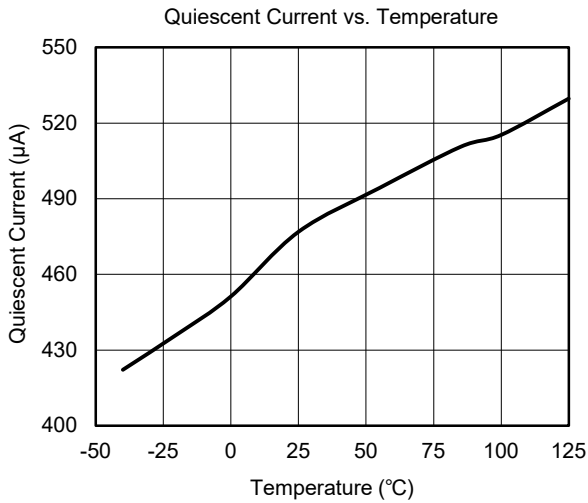
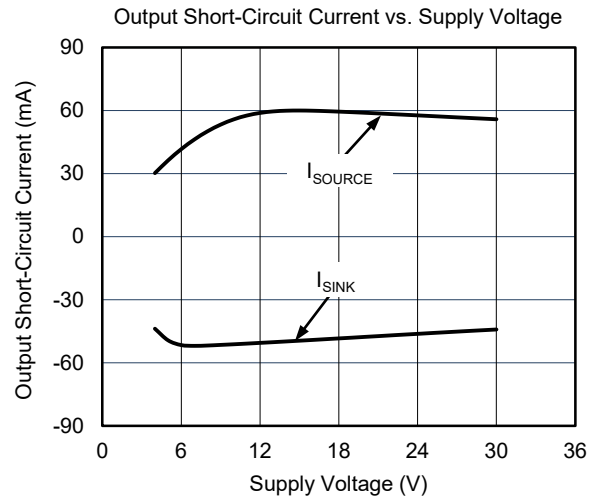
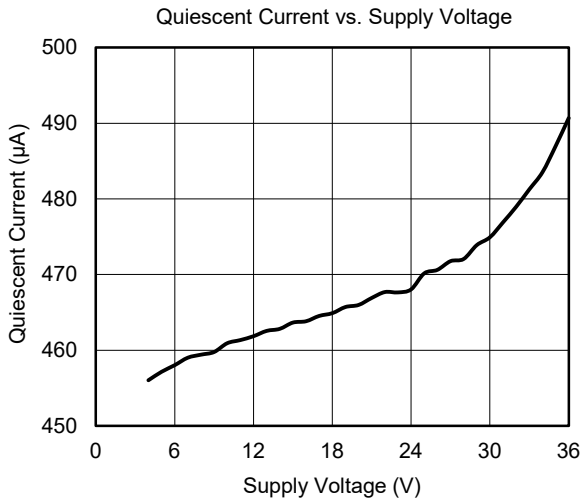

SGM8251 2.8MHz, High Voltage, High Precision, Low Noise Rail-to-Rail Output Operational Amplifier

TYPICAL PERFORMANCE CHARACTERISTICS (continued)

At $T_A = +25^\circ\text{C}$, $V_S = \pm 15\text{V}$, $C_L = 10\text{pF}$ and $R_L = 10\text{k}\Omega$, unless otherwise noted.

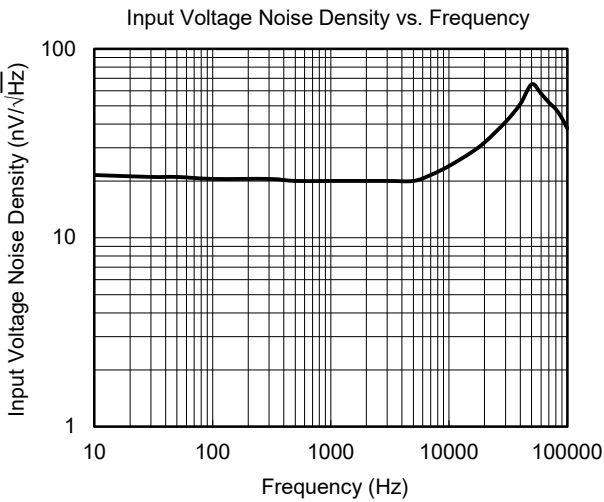
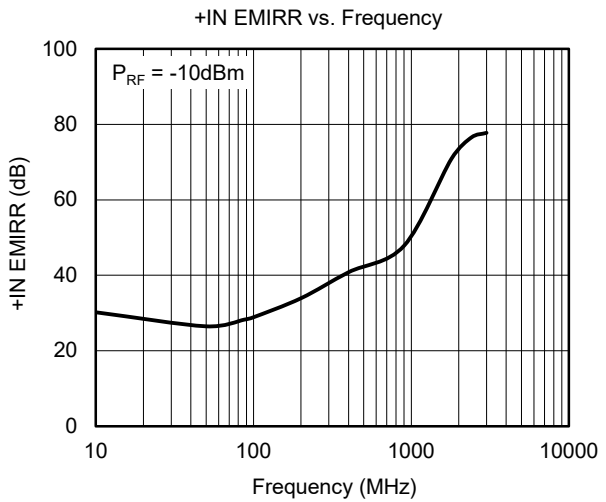
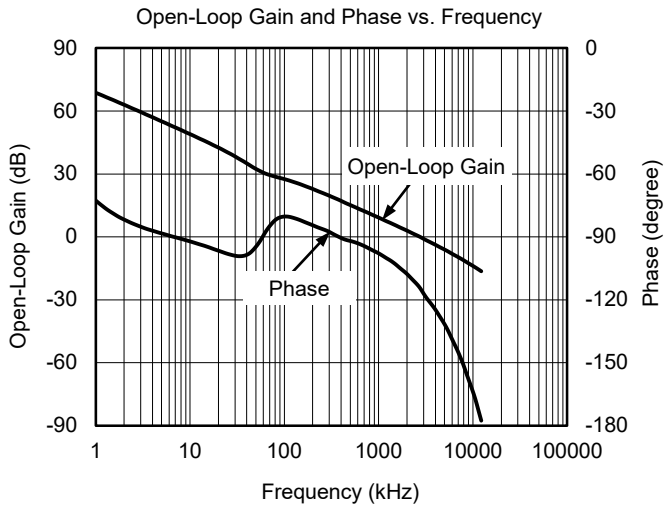
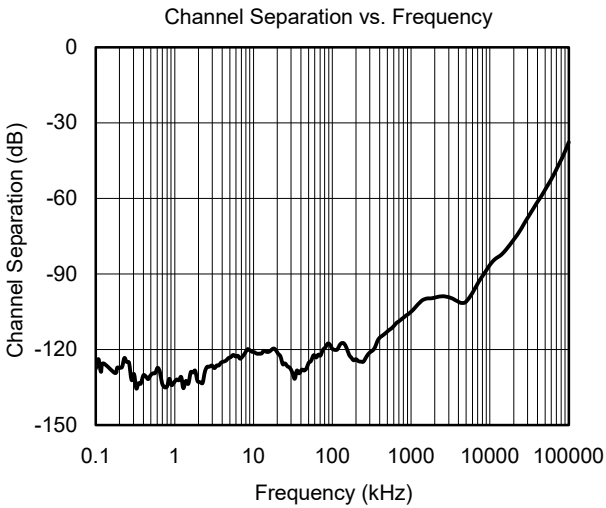
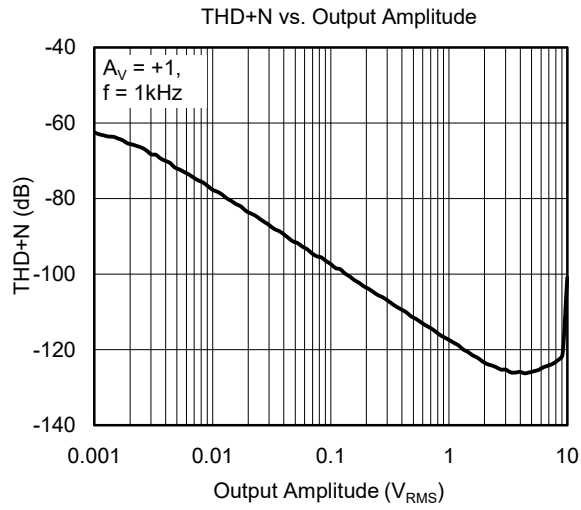
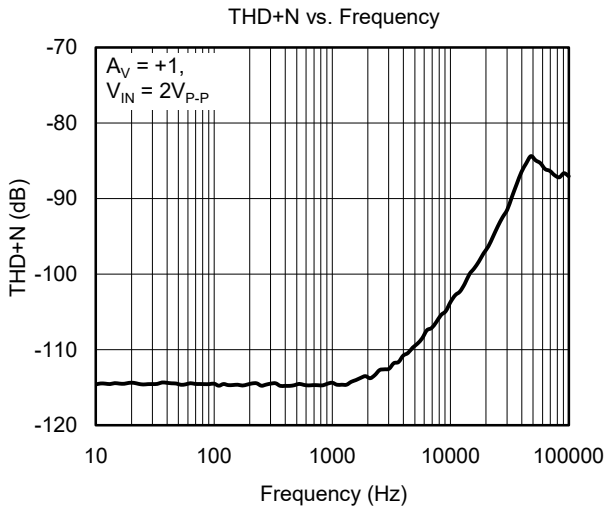

TYPICAL PERFORMANCE CHARACTERISTICS (continued)

At $T_A = +25^\circ\text{C}$, $V_S = \pm 15\text{V}$, $C_L = 10\text{pF}$ and $R_L = 10\text{k}\Omega$, unless otherwise noted.

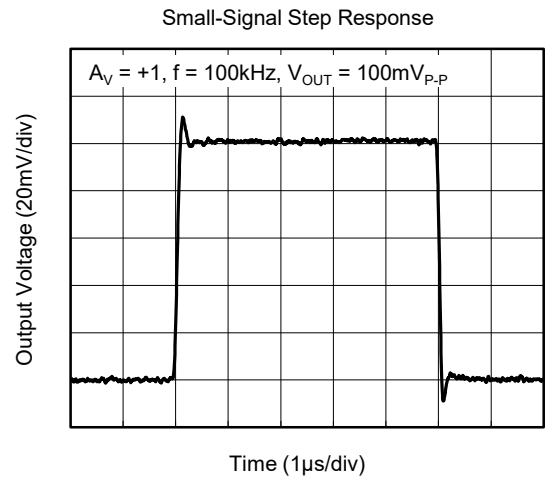
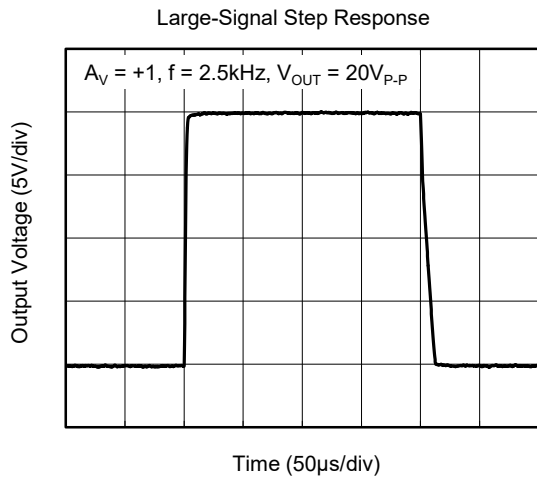
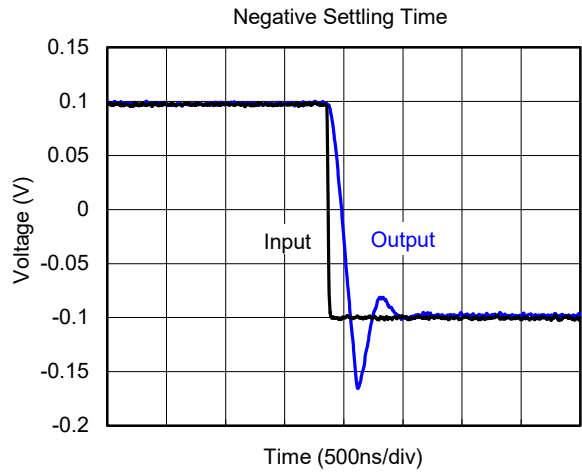
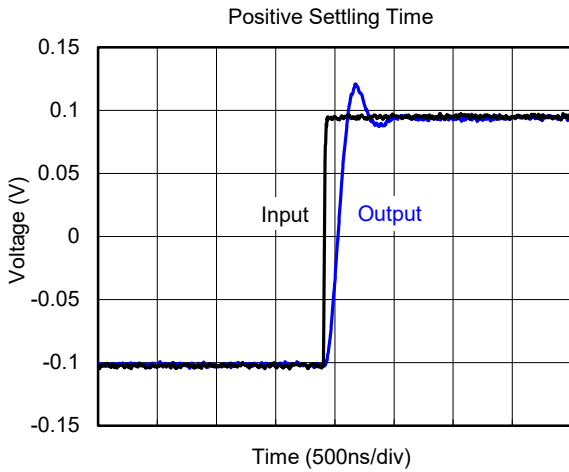
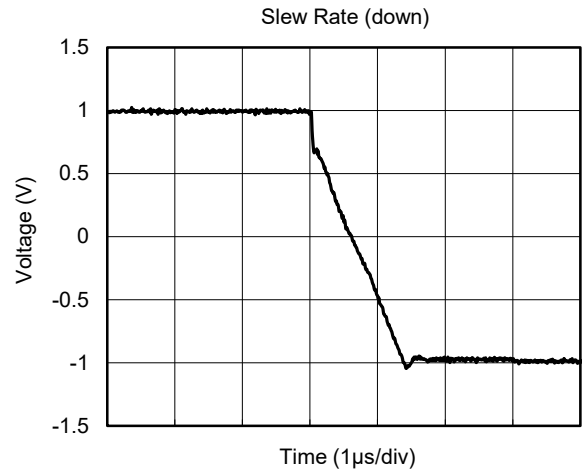
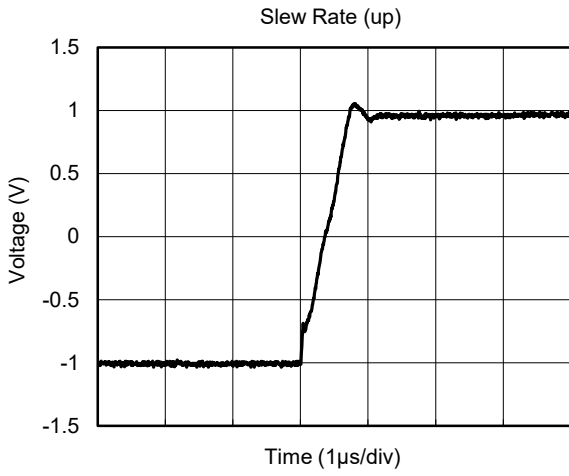

TYPICAL PERFORMANCE CHARACTERISTICS (continued)

At $T_A = +25^\circ\text{C}$, $V_S = \pm 15\text{V}$, $C_L = 10\text{pF}$ and $R_L = 10\text{k}\Omega$, unless otherwise noted.

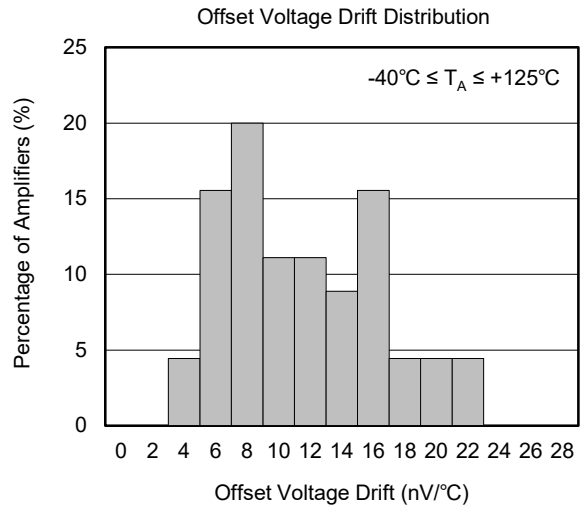
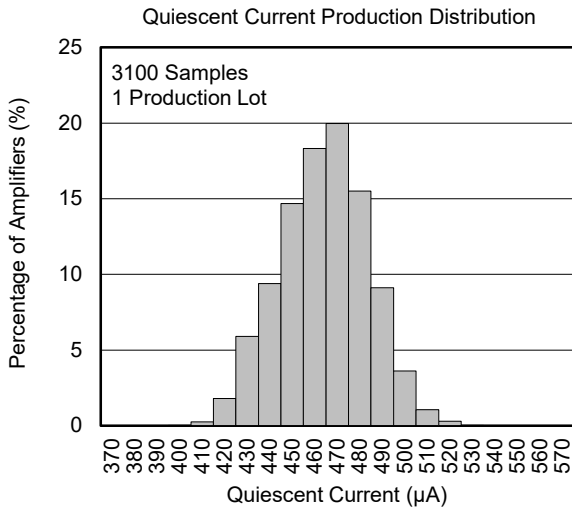
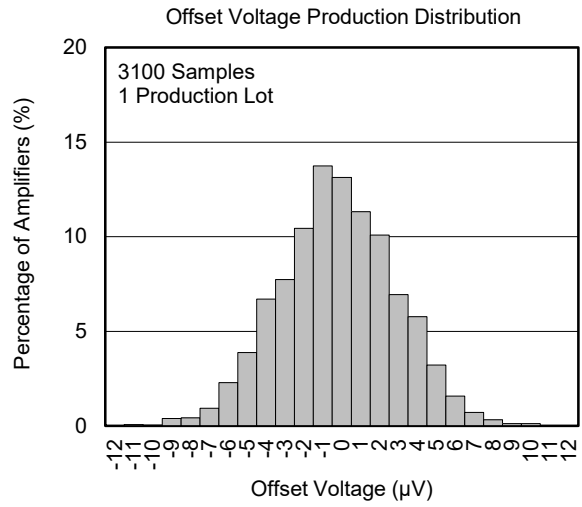
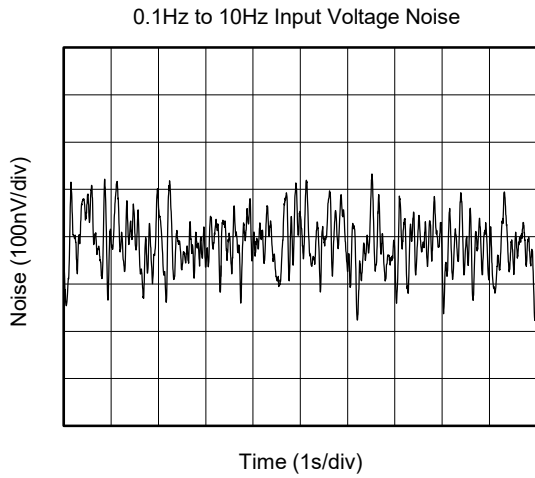

APPLICATION NOTES

Driving Capacitive Loads

The unity-gain follower (buffer) is the most sensitive configuration to capacitive loading. Direct capacitive loading reduces the phase margin of amplifiers and this results in ringing or even oscillation. Applications that require greater capacitive driving capability should use an isolation resistor between the output and the capacitive load like the circuit in Figure 1. The isolation resistor R_{ISO} and the load capacitor C_L form a zero to increase stability. The bigger the R_{ISO} resistor value, the more stable V_{OUT} will be. Note that this method results in a loss of gain accuracy because R_{ISO} forms a voltage divider with the R_{LOAD} .

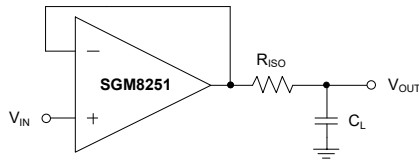

Figure 1. Indirectly Driving Heavy Capacitive Load

An improved circuit is shown in Figure 2. It provides DC accuracy as well as AC stability. R_F provides the DC accuracy by connecting the inverting input with the output. C_F and R_{ISO} serve to counteract the loss of phase margin by feeding the high frequency component of the output signal back to the amplifier's inverting input, thereby preserving phase margin in the overall feedback loop.

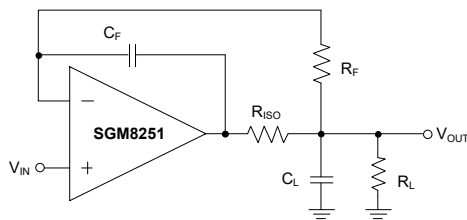

Figure 2. Indirectly Driving Heavy Capacitive Load with DC Accuracy

For non-buffer configuration, there are two other ways to increase the phase margin: (a) by increasing the amplifier's closed-loop gain or (b) by placing a capacitor in parallel with the feedback resistor to counteract the parasitic capacitance associated with inverting node.

Power Supply Bypassing and Layout

The SGM8251 operates from either a single 4.5V to 36V supply or dual $\pm 2.25V$ to $\pm 18V$ supplies. For

single-supply operation, bypass the power supply $+V_S$ with a $0.1\mu F$ ceramic capacitor which should be placed close to the $+V_S$ pin. For dual-supply operation, both the $+V_S$ and the $-V_S$ supplies should be bypassed to ground with separate $0.1\mu F$ ceramic capacitors. $2.2\mu F$ tantalum capacitor can be added for better performance.

Good PC board layout techniques optimize performance by decreasing the amount of stray capacitance at the operational amplifier's inputs and output. To decrease stray capacitance, minimize trace lengths and widths by placing external components as close to the device as possible. Use surface-mount components whenever possible.

For the operational amplifier, soldering the part to the board directly is strongly recommended. Try to keep the high frequency current loop area small to minimize the EMI (electromagnetic interference).

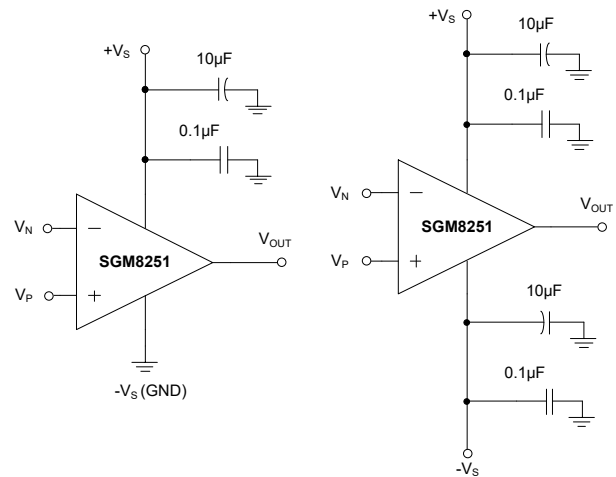

Figure 3. Amplifier with Bypass Capacitors

Grounding

A ground plane layer is important for SGM8251 circuit design. The length of the current path in an inductive ground return will create an unwanted voltage noise. Broad ground plane areas will reduce the parasitic inductance.

Input-to-Output Coupling

To minimize capacitive coupling, the input and output signal traces should not be in parallel. This helps reduce unwanted positive feedback.

TYPICAL APPLICATION CIRCUITS

Differential Amplifier

The circuit shown in Figure 4 performs the difference function. If the resistor ratios are equal ($R_4/R_3 = R_2/R_1$), then $V_{OUT} = (V_P - V_N) \times R_2/R_1 + V_{REF}$.

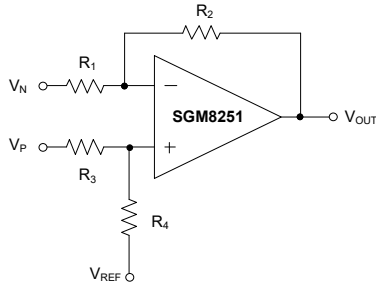

Figure 4. Differential Amplifier

Instrumentation Amplifier

The circuit in Figure 5 performs the same function as that in Figure 4 but with a high input impedance.

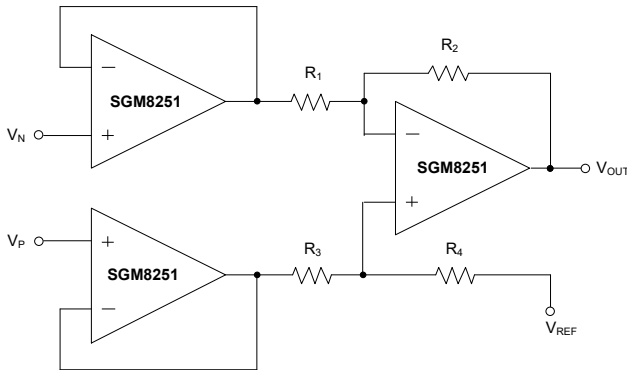

Figure 5. Instrumentation Amplifier

Active Low-Pass Filter

The low-pass filter shown in Figure 6 has a DC gain of $(-R_2/R_1)$ and the -3dB corner frequency is $1/2\pi R_2 C$. Make sure the filter bandwidth is within the bandwidth of the amplifier. Feedback resistors with large values can couple with parasitic capacitance and cause undesired effects such as ringing or oscillation in high-speed amplifiers. Keep resistor values as low as possible and consistent with output loading consideration.

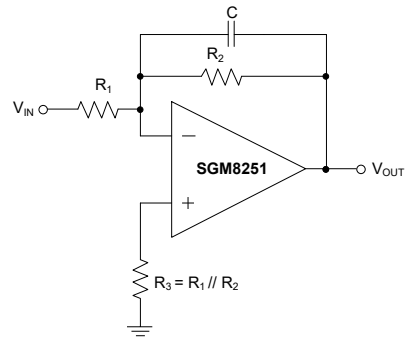

Figure 6. Active Low-Pass Filter

REVISION HISTORY

NOTE: Page numbers for previous revisions may differ from page numbers in the current version.

SEPTEMBER 2019 – REV.A to REV.B	Page
New version.....	All

Changes from Original (SEPTEMBER 2015) to REV.A	Page
Changed from product preview to production data.....	All

PACKAGE INFORMATION

PACKAGE OUTLINE DIMENSIONS

SOT-23-5

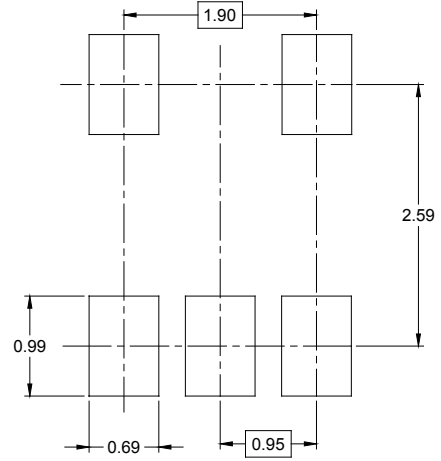
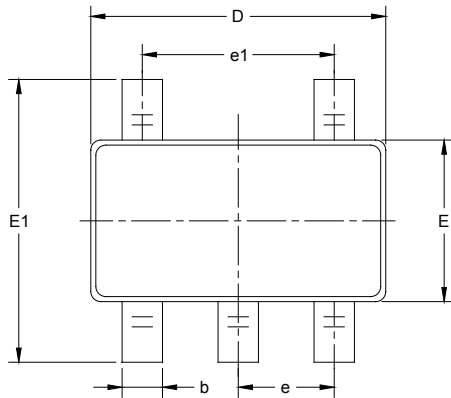

RECOMMENDED LAND PATTERN (Unit: mm)

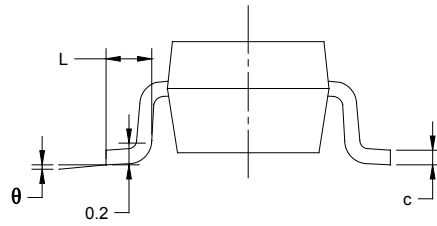
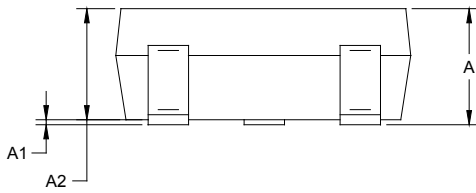

Symbol	Dimensions In Millimeters		Dimensions In Inches	
	MIN	MAX	MIN	MAX
A	1.050	1.250	0.041	0.049
A1	0.000	0.100	0.000	0.004
A2	1.050	1.150	0.041	0.045
b	0.300	0.500	0.012	0.020
c	0.100	0.200	0.004	0.008
D	2.820	3.020	0.111	0.119
E	1.500	1.700	0.059	0.067
E1	2.650	2.950	0.104	0.116
e	0.950 BSC		0.037 BSC	
e1	1.900 BSC		0.075 BSC	
L	0.300	0.600	0.012	0.024
θ	0°	8°	0°	8°

PACKAGE INFORMATION

PACKAGE OUTLINE DIMENSIONS

SOIC-8

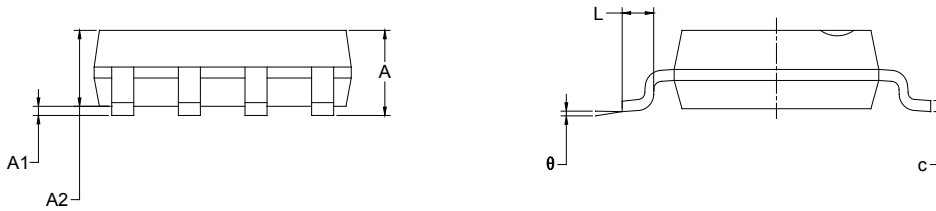
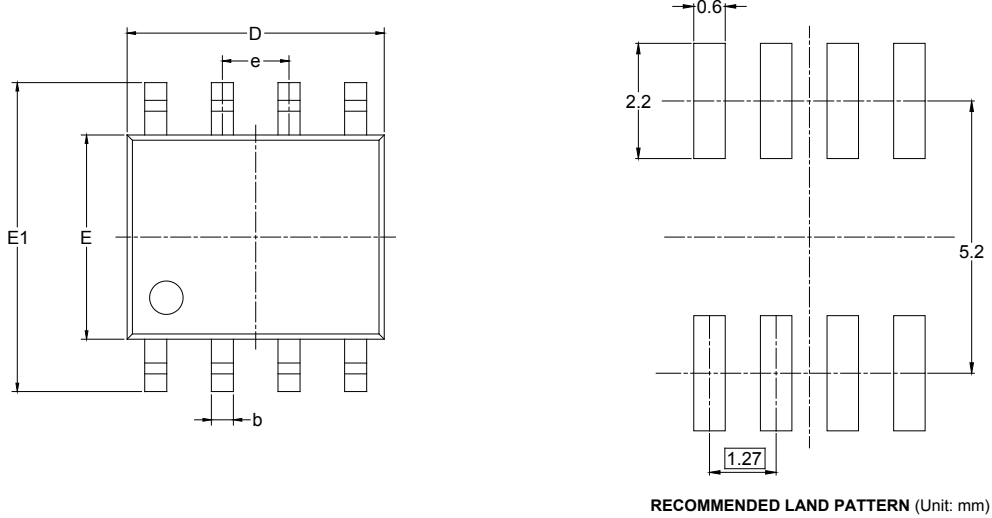

Symbol	Dimensions In Millimeters		Dimensions In Inches	
	MIN	MAX	MIN	MAX
A	1.350	1.750	0.053	0.069
A1	0.100	0.250	0.004	0.010
A2	1.350	1.550	0.053	0.061
b	0.330	0.510	0.013	0.020
c	0.170	0.250	0.006	0.010
D	4.700	5.100	0.185	0.200
E	3.800	4.000	0.150	0.157
E1	5.800	6.200	0.228	0.244
e	1.27 BSC		0.050 BSC	
L	0.400	1.270	0.016	0.050
θ	0°	8°	0°	8°

PACKAGE OUTLINE DIMENSIONS

MSOP-8

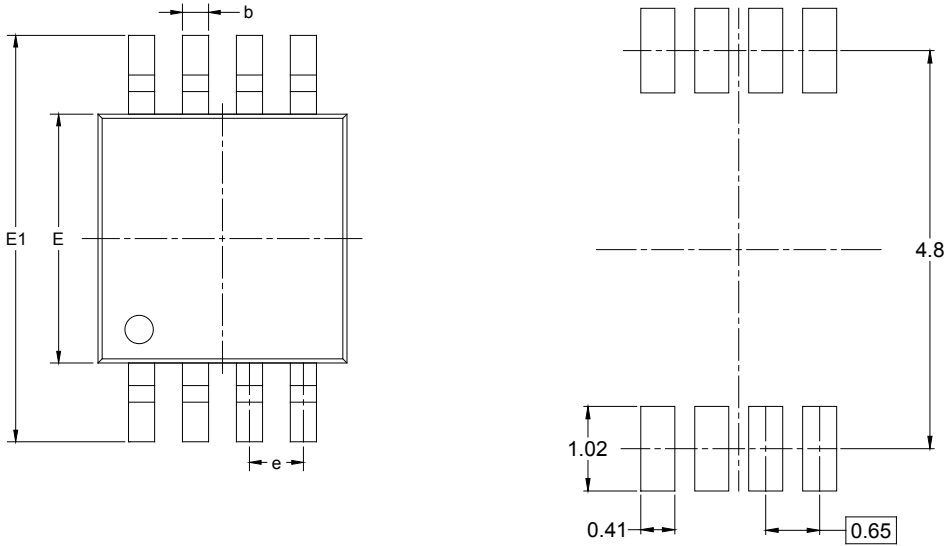

RECOMMENDED LAND PATTERN (Unit: mm)

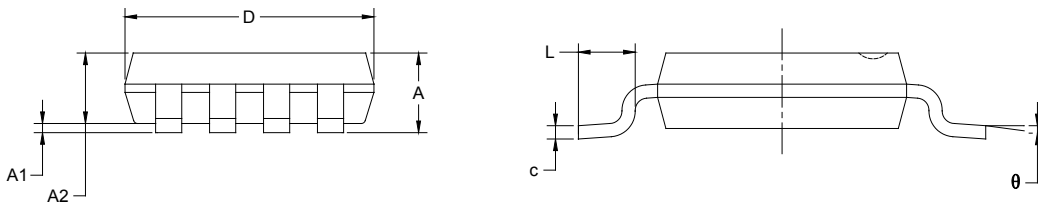

Symbol	Dimensions In Millimeters		Dimensions In Inches	
	MIN	MAX	MIN	MAX
A	0.820	1.100	0.032	0.043
A1	0.020	0.150	0.001	0.006
A2	0.750	0.950	0.030	0.037
b	0.250	0.380	0.010	0.015
c	0.090	0.230	0.004	0.009
D	2.900	3.100	0.114	0.122
E	2.900	3.100	0.114	0.122
E1	4.750	5.050	0.187	0.199
e	0.650 BSC		0.026 BSC	
L	0.400	0.800	0.016	0.031
θ	0°	6°	0°	6°

PACKAGE INFORMATION

TAPE AND REEL INFORMATION

REEL DIMENSIONS

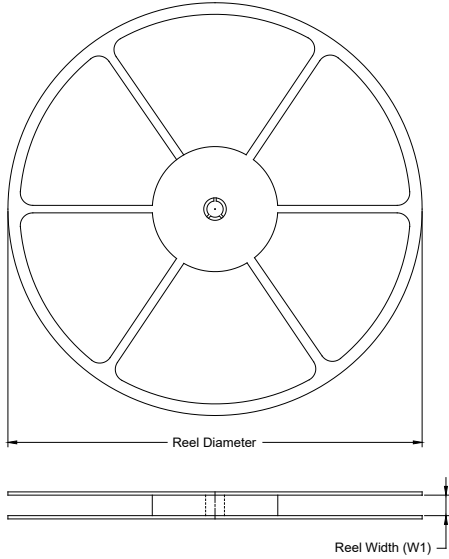

TAPE DIMENSIONS



NOTE: The picture is only for reference. Please make the object as the standard.

KEY PARAMETER LIST OF TAPE AND REEL

Package Type	Reel Diameter	Reel Width W1 (mm)	A0 (mm)	B0 (mm)	K0 (mm)	P0 (mm)	P1 (mm)	P2 (mm)	W (mm)	Pin1 Quadrant
SOT-23-5	7"	9.5	3.20	3.20	1.40	4.0	4.0	2.0	8.0	Q3
SOIC-8	13"	12.4	6.40	5.40	2.10	4.0	8.0	2.0	12.0	Q1
MSOP-8	13"	12.4	5.20	3.30	1.50	4.0	8.0	2.0	12.0	Q1

DD0001

PACKAGE INFORMATION

CARTON BOX DIMENSIONS



NOTE: The picture is only for reference. Please make the object as the standard.

KEY PARAMETER LIST OF CARTON BOX

Reel Type	Length (mm)	Width (mm)	Height (mm)	Pizza/Carton
7" (Option)	368	227	224	8
7"	442	410	224	18
13"	386	280	370	5

DD0002