

SGM2050

3A, High Accuracy, Low Noise, Low Dropout Linear Regulator

GENERAL DESCRIPTION

The SGM2050 is a high accuracy, low noise, very low dropout linear regulator. It is capable of supplying 3A output current with typical dropout voltage of only 99mV. The operating input voltage range is from 1.1V to 7V with BIAS and 1.4V to 7V without BIAS. The output voltage can be set from 0.8V to 3.95V in pin-selectable operation and adjusted from 0.8V to 5.2V by using an external resistor divider.

Other features include logic-controlled shutdown mode, short-circuit current limit and thermal shutdown protection. The SGM2050 has automatic discharge function to quickly discharge V_{OUT} in the disabled status.

The SGM2050 is suitable for application which needs high accuracy, low noise and high current power supply, such as analog-to-digital converters (ADCs), digital-to-analog converters (DACs) and RF components.

With very high accuracy, remote sensing, and soft-start capabilities to reduce inrush current, the SGM2050 ensures the optimal system performance for powering digital loads such as FPGAs, DSPs and ASICs.

The SGM2050 is available in a Green TQFN-3.5×3.5-20L package. It operates over an operating temperature range of -40°C to +125°C.

APPLICATIONS

Wireless Equipment
Industrial, Instrumentation and Medical
ADC and DAC
ATE

FEATURES

- **Input Voltage Range:**
 - ♦ Without BIAS: 1.4V to 7V
 - ♦ With BIAS: 1.1V to 7V
- **Output Voltage Range:**
 - ♦ Adjustable Operation: 0.8V to 5.2V
 - ♦ Pin-Selectable Operation: 0.8V to 3.95V
- **Output Voltage Accuracy: $\pm 1\%$ at +25°C**
- **Low Dropout Voltage: 99mV (TYP) at 3A**
- **Low Noise: $5\mu V_{RMS}$ (TYP) with BIAS**
- **Excellent Load Transient Response**
- **Adjustable Soft-Start Inrush Control**
- **Open-Drain Power-Good (PG) Output**
- **-40°C to +125°C Operating Temperature Range**
- **Available in a Green TQFN-3.5×3.5-20L Package**

TYPICAL APPLICATION

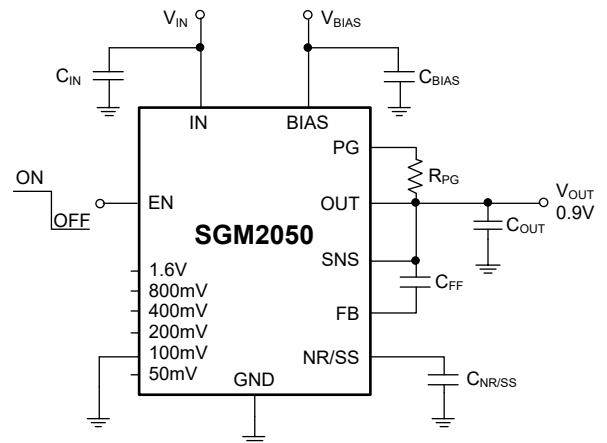

Figure 1. Typical Application Circuit

PACKAGE/ORDERING INFORMATION

MODEL	PACKAGE DESCRIPTION	SPECIFIED TEMPERATURE RANGE	ORDERING NUMBER	PACKAGE MARKING	PACKING OPTION
SGM2050	TQFN-3.5×3.5-20L	-40°C to +125°C	SGM2050XTRL20G/TR	SGM2050 XTRL20 XXXXX	Tape and Reel, 4000

MARKING INFORMATION

NOTE: XXXXX = Date Code, Trace Code and Vendor Code.

XXXXX

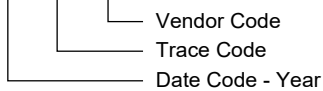

Green (RoHS & HSF): SG Micro Corp defines "Green" to mean Pb-Free (RoHS compatible) and free of halogen substances. If you have additional comments or questions, please contact your SGMICRO representative directly.

ABSOLUTE MAXIMUM RATINGS

IN, BIAS, PG, EN to GND	-0.3V to 8V
SNS, OUT to GND	-0.3V to Min(V _{IN} + 0.3V, 8V)
NR/SS, FB to GND	-0.3V to 3.6V
50mV, 100mV, 200mV, 400mV, 800mV, 1.6V to GND	-0.3V to (V _{OUT} + 0.3V)
PG Current (Sink Current into Device).....	5mA
Package Thermal Resistance	
TQFN-3.5×3.5-20L, θ _{JA}	40°C/W
TQFN-3.5×3.5-20L, θ _{JB}	14°C/W
TQFN-3.5×3.5-20L, θ _{JC}	29°C/W
Junction Temperature.....	+150°C
Storage Temperature Range	-65°C to +150°C
Lead Temperature (Soldering, 10s).....	+260°C
ESD Susceptibility	
HBM.....	6000V
CDM	1000V

RECOMMENDED OPERATING CONDITIONS

Input Supply Voltage Range	1.1V to 7V
Bias Supply Voltage Range ⁽¹⁾	3V to 7V
Output Voltage Range ⁽²⁾	0.8V to 5.2V
Enable Voltage Range	0V to V _{IN}
Output Current	0A to 3A
Input Effective Capacitance, C _{IN}	5µF (MIN)
Output Effective Capacitance, C _{OUT}	10µF to 1000µF
Bias Effective Capacitance, C _{BIAS}	5µF (MIN)
Power-Good Pull-Up Resistance	10kΩ to 100kΩ
Operating Junction Temperature Range.....	-40°C to +125°C

NOTES:

1. Bias supply is required when the V_{IN} supply is below 1.4V. Conversely, no bias supply is required when the V_{IN} supply is higher than or equal to 1.4V.
2. This output voltage range does not include device accuracy or accuracy of the feedback resistors.

OVERSTRESS CAUTION

Stresses beyond those listed in Absolute Maximum Ratings may cause permanent damage to the device. Exposure to absolute maximum rating conditions for extended periods may affect reliability. Functional operation of the device at any conditions beyond those indicated in the Recommended Operating Conditions section is not implied.

ESD SENSITIVITY CAUTION

This integrated circuit can be damaged if ESD protections are not considered carefully. SGMICRO recommends that all integrated circuits be handled with appropriate precautions. Failure to observe proper handling and installation procedures can cause damage. ESD damage can range from subtle performance degradation to complete device failure. Precision integrated circuits may be more susceptible to damage because even small parametric changes could cause the device not to meet the published specifications.

DISCLAIMER

SG Micro Corp reserves the right to make any change in circuit design, or specifications without prior notice.

PIN CONFIGURATION

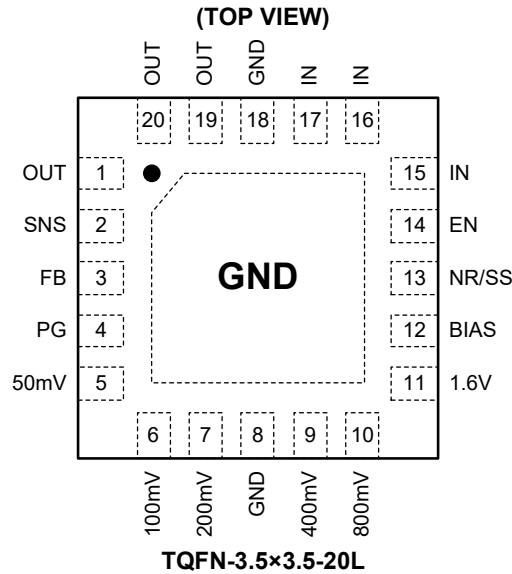

PIN DESCRIPTION

PIN	NAME	FUNCTION
1, 19, 20	OUT	Regulator Output Pin. It is recommended to use an output capacitor with effective capacitance in the range of 10µF to 1000µF. The capacitor should be located very close to this pin.
2	SNS	Output Voltage Sense Input Pin. Connect this pin to the load side of the output trace only if the pin-selectable feature is used. Keep SNS pin floating if the V _{OUT} voltage is set by external resistor.
3	FB	Feedback Voltage Input Pin. Connect this pin to the external resistor divider to adjust the output voltage.
4	PG	Power-Good Indicator Output Pin. An open-drain output and active high when the output voltage reaches V _{IT(PG)} of the target. The pin is pulled to ground when the output voltage is lower than its specified threshold, EN shutdown, OCP and OTP.
5	50mV	Output Voltage Setting Pins. Connect these pins to ground or leave floating. Connecting these pins to ground increases the output voltage by the value of the pin name; multiple pins can be simultaneously connected to GND to select the desired output voltage. Leave these pins floating (open) if the V _{OUT} voltage is set by external resistor.
6	100mV	
7	200mV	
9	400mV	
10	800mV	
11	1.6V	
12	BIAS	Bias Supply Voltage Pin for Internal Control Circuits. This pin enables the use of low-input voltage, low-output voltage conditions (V _{IN} < 1.4V). This pin must be left floating or tied to ground if not used.
13	NR/SS	Noise-Reduction and Soft-Start Pin. Using an external capacitor C _{NR/SS} to decouple this pin to GND can not only reduce output noise to very low level but also slow down the V _{OUT} rise like a soft-start behavior.
14	EN	Enable Pin. Driving EN high to turn on the regulator. Driving EN low to turn off the regulator. This pin must be connected to IN or BIAS pin if enable functionality is not used.
15, 16, 17	IN	Input Supply Voltage Pin. It is recommended to use a 10µF or larger ceramic capacitor from IN pin to ground.
8, 18	GND	Ground. These pins must be connected to ground, the exposed pad and each other with a low-impedance connection.
Exposed Pad	GND	Exposed Pad. Exposed pad is internally connected to GND. Connect it to a large ground plane to maximize thermal performance; not intended as an electrical connection point.

ELECTRICAL CHARACTERISTICS

($V_{IN} = (V_{OUT(NOM)} + 0.4V)$ or 1.4V (whichever is greater), $V_{BIAS} = \text{Open}$, $V_{OUT(NOM)} = 0.8V$ ⁽¹⁾, $V_{EN} = 1.1V$, $C_{IN} = 10\mu F$, $C_{OUT} = 47\mu F$, $C_{NR/SS} = 0nF$, $C_{FF} = 0nF$ and PG pin pulled up to V_{IN} with 100k Ω , $T_J = -40^\circ C$ to $+125^\circ C$, typical values are at $T_J = +25^\circ C$, unless otherwise noted.)

PARAMETER	SYMBOL	CONDITIONS	MIN	TYP	MAX	UNITS	
Input Supply Voltage Range ⁽²⁾	V_{IN}		1.1		7	V	
Bias Supply Voltage Range ⁽²⁾	V_{BIAS}	$V_{IN} = 1.1V$	3		7	V	
Output Voltage Range	V_{OUT}	Pin-selectable operation	0.8		3.95	V	
		Adjustable operation, using external resistors ⁽³⁾	0.8		5.2		
Feedback Voltage	V_{FB}	$T_J = +25^\circ C$	0.792	0.8	0.808	V	
			0.784		0.816		
NR/SS Pin Voltage	$V_{NR/SS}$			0.8		V	
Input Supply UVLO with Bias	$V_{UVLO1(IN)}$	V_{IN} rising with $V_{BIAS} = 3V$		0.78	0.95	V	
$V_{UVLO1(IN)}$ Hysteresis	$V_{HYS1(IN)}$	$V_{BIAS} = 3V$		100		mV	
Input Supply UVLO without Bias	$V_{UVLO2(IN)}$	V_{IN} rising		1.14	1.4	V	
$V_{UVLO2(IN)}$ Hysteresis	$V_{HYS2(IN)}$			40		mV	
Bias Supply UVLO	$V_{UVLO(BIAS)}$	V_{BIAS} rising, $V_{IN} = 1.1V$		2.5	2.8	V	
$V_{UVLO(BIAS)}$ Hysteresis	$V_{HYS(BIAS)}$	$V_{IN} = 1.1V$		260		mV	
Output Voltage Accuracy ⁽⁴⁾	V_{OUT}	$V_{IN} = 1.4V$ to 7V without BIAS, or $V_{IN} = 1.1V$, $V_{BIAS} = 3V$ to 7V, $I_{OUT} = 5mA$ to 3A	$T_J = +25^\circ C$	-1		1	%
			$T_J = -40^\circ C$ to $+125^\circ C$	-1.7		1.3	
		Pin-selectable operation, $I_{OUT} = 5mA$	$T_J = +25^\circ C$	-1.4		1.4	
			$T_J = -40^\circ C$ to $+125^\circ C$	-2		2	
Line Regulation	$\Delta V_{OUT}/\Delta V_{IN}$	$V_{IN} = 1.4V$ to 7V, $I_{OUT} = 5mA$		0.04	1.5	mV/V	
Load Regulation	$\Delta V_{OUT}/\Delta I_{OUT}$	$V_{BIAS} = 3V$ to 7V, $V_{IN} = 1.1V$, $I_{OUT} = 5mA$ to 3A		0.1	1.8	mV/A	
		$I_{OUT} = 5mA$ to 3A		0.1	2.2		
		$I_{OUT} = 5mA$ to 3A, $V_{OUT} = 5.2V$		0.7	4.5		
Dropout Voltage	V_{DROP}	$V_{IN} = 1.4V$, $I_{OUT} = 3A$, $V_{FB} = 0.776V$		99	160	mV	
		$V_{IN} = 5.2V$, $I_{OUT} = 3A$, $V_{FB} = 0.776V$		99	160		
		$V_{IN} = 1.1V$, $V_{BIAS} = 5V$, $I_{OUT} = 3A$, $V_{FB} = 0.776V$		99	160		
Output Current Limit	I_{LIMIT}	V_{OUT} forced at $90\% \times V_{OUT(NOM)}$, $V_{IN} = V_{OUT(NOM)} + 0.4V$	3.1	4.1	5.2	A	
Short-Circuit Current Limit	I_{SC}	$R_{LOAD} = 20m\Omega$, under foldback operation		2		A	
GND Pin Current	I_{GND}	$V_{IN} = 7V$, $I_{OUT} = 5mA$		3.3	4.1	mA	
		$V_{IN} = 1.4V$, $I_{OUT} = 3A$		2.3	3		
Shutdown Current	I_{SHDN}	PG = Open, $V_{IN} = 7V$, $V_{EN} = 0.5V$, $T_J = +25^\circ C$		1.4	3	μA	
		PG = Open, $V_{IN} = 7V$, $V_{EN} = 0.5V$			15		
BIAS Pin Current	I_{BIAS}	$V_{IN} = 1.1V$, $V_{BIAS} = 7V$, $V_{OUT(NOM)} = 0.8V$, $I_{OUT} = 3A$		2.9	3.6	mA	
EN Pin Low-Level Input Voltage	$V_{IL(EN)}$	EN input voltage "L"	0		0.5	V	
EN Pin High-Level Input Voltage	$V_{IH(EN)}$	EN input voltage "H"	1.1		7	V	
EN Pin Current	I_{EN}	$V_{IN} = 7V$, $V_{EN} = 0V$ and 7V	-0.3		0.3	μA	
Turn-On Time	t_{ON}	From assertion of V_{EN} to $V_{OUT} = 90\% \times V_{OUT(NOM)}$		300		μs	
Output Discharge Resistance	R_{DIS}	$V_{IN} = 1.4V$, $V_{EN} = 0V$, $V_{OUT} = 0.5V$	190	260	330	Ω	

ELECTRICAL CHARACTERISTICS (continued)

($V_{IN} = (V_{OUT(NOM)} + 0.4V)$ or 1.4V (whichever is greater), $V_{BIAS} = \text{Open}$, $V_{OUT(NOM)} = 0.8V$ ⁽¹⁾, $V_{EN} = 1.1V$, $C_{IN} = 10\mu F$, $C_{OUT} = 47\mu F$, $C_{NR/SS} = 0nF$, $C_{FF} = 0nF$ and PG pin pulled up to V_{IN} with 100k Ω , $T_J = -40^\circ C$ to $+125^\circ C$, typical values are at $T_J = +25^\circ C$, unless otherwise noted.)

PARAMETER	SYMBOL	CONDITIONS	MIN	TYP	MAX	UNITS
PG Pin Threshold	$V_{IT(PG)}$	For falling V_{OUT}	$84\% \times V_{OUT}$	$89\% \times V_{OUT}$	$93\% \times V_{OUT}$	V
PG Pin Hysteresis	$V_{HYS(PG)}$	For rising V_{OUT}		$1.7\% \times V_{OUT}$		V
PG Pin Low-Level Output Voltage	$V_{OL(PG)}$	$V_{OUT} < V_{IT(PG)}$, $I_{PG} = -1mA$ (current into device)		0.17	0.3	V
PG Pin Leakage Current	$I_{kg(PG)}$	$V_{OUT} > V_{IT(PG)}$, $V_{PG} = 7V$, $V_{IN} = 7V$		0.01	0.5	μA
NR/SS Pin Charging Current	$I_{NR/SS}$	$V_{NR/SS} = GND$, $V_{IN} = 7V$	3.5	5.8	8.5	μA
FB Pin Leakage Current	I_{FB}	$V_{IN} = 7V$	-120		120	nA
Power Supply Rejection Ratio	PSRR	V_{IN} to V_{OUT} , $V_{OUT} = 0.8V$, $V_{BIAS} = 5V$, ($V_{IN} - V_{OUT}$) = 0.4V, $I_{OUT} = 3A$, $C_{NR/SS} = 100nF$, $C_{FF} = 10nF$, $C_{OUT} = 47\mu F \parallel 10\mu F \parallel 10\mu F$	f = 10kHz	48		dB
			f = 500kHz	36		
		V_{IN} to V_{OUT} , $V_{OUT} = 5V$, ($V_{IN} - V_{OUT}$) = 0.4V, $I_{OUT} = 3A$, $C_{NR/SS} = 100nF$, $C_{FF} = 10nF$, $C_{OUT} = 47\mu F \parallel 10\mu F \parallel 10\mu F$	f = 10kHz	48		
			f = 500kHz	26		
Output Noise Voltage	e_n	f = 10Hz to 100kHz, $I_{OUT} = 3A$, $C_{NR/SS} = 100nF$, $C_{FF} = 10nF$, $C_{OUT} = 47\mu F \parallel 10\mu F \parallel 10\mu F$	$V_{OUT} = 0.8V$, $V_{IN} = 1.1V$, $V_{BIAS} = 5V$	5		μV_{RMS}
			$V_{OUT} = 5V$, $V_{IN} = 5.4V$, $V_{BIAS} = 0V$	11		
Thermal Shutdown Temperature	T_{SHDN}			165		$^\circ C$
Thermal Shutdown Hysteresis	ΔT_{SHDN}			25		$^\circ C$

NOTES:

- $V_{OUT(NOM)}$ is the calculated V_{OUT} target value from the pin-selectable in a fixed configuration. In an adjustable configuration, $V_{OUT(NOM)}$ is the expected V_{OUT} value set by the external feedback resistors.
- The bias supply is required when the V_{IN} supply is below 1.4V. Conversely, no bias supply is required when the V_{IN} supply is higher than or equal to 1.4V.
- When the device is connected to external feedback resistors at the FB pin, external resistor tolerances are not included.
- When the $I_{OUT} = 3A$, $V_{IN} = 1.1V$ with BIAS, or $V_{IN} = 1.4V$ without BIAS.

TYPICAL PERFORMANCE CHARACTERISTICS

$T_J = +25^\circ\text{C}$, $V_{IN} = (V_{OUT(NOM)} + 0.4\text{V})$ or 1.4V (whichever is greater), $V_{BIAS} = \text{Open}$, $V_{OUT(NOM)} = 0.8\text{V}$, $V_{EN} = 1.1\text{V}$, $C_{IN} = 10\mu\text{F}$, $C_{OUT} = 47\mu\text{F}$, $C_{NR/SS} = 0\text{nF}$, no C_{FF} , and PG pin pulled up to V_{IN} with $100\text{k}\Omega$, unless otherwise noted.

V_{IN} Line Transient Response without BIAS

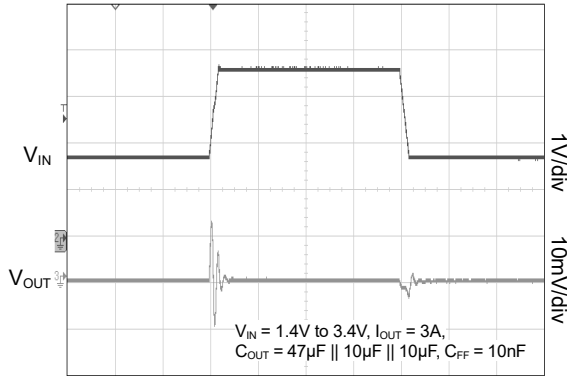

Time (50µs/div)

V_{BIAS} Line Transient Response

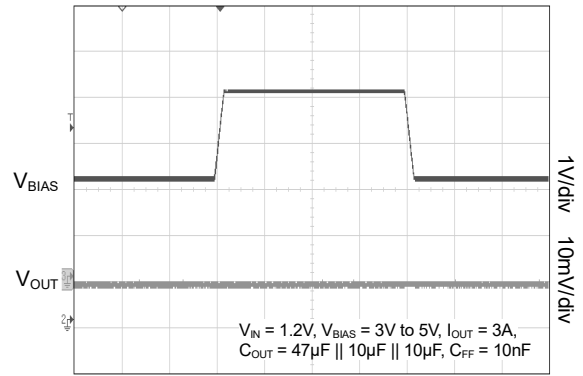

Time (50µs/div)

Load Transient Response with BIAS

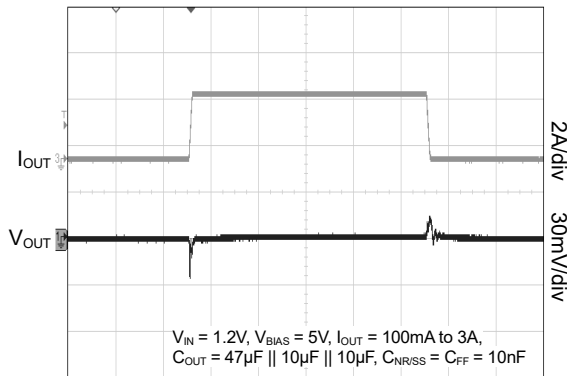

Time (200µs/div)

Load Transient Response without BIAS

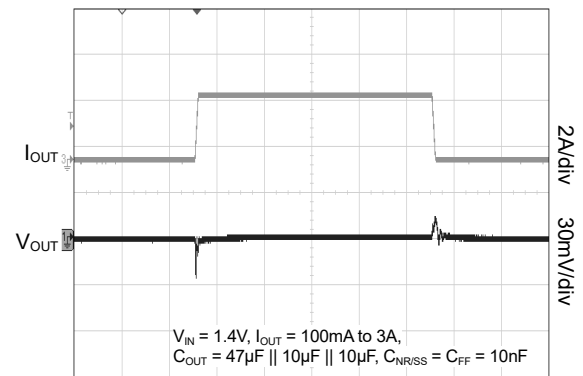

Time (200µs/div)

Enable Turn-On Response

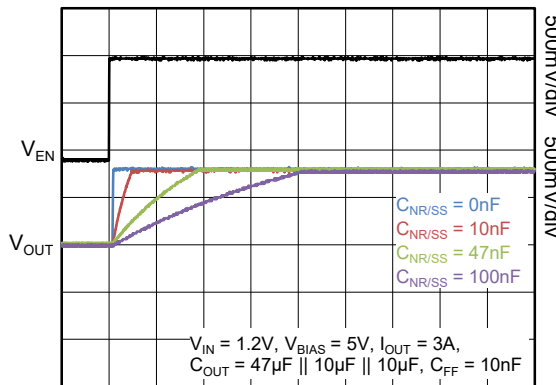

Time (5ms/div)

Enable Turn-Off Response

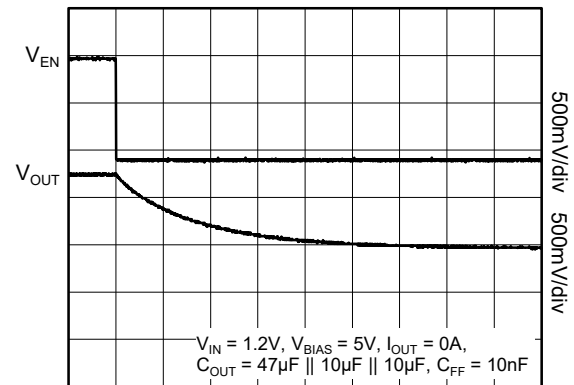

Time (5ms/div)

TYPICAL PERFORMANCE CHARACTERISTICS (continued)

$T_J = +25^\circ\text{C}$, $V_{IN} = (V_{OUT(NOM)} + 0.4\text{V})$ or 1.4V (whichever is greater), $V_{BIAS} = \text{Open}$, $V_{OUT(NOM)} = 0.8\text{V}$, $V_{EN} = 1.1\text{V}$, $C_{IN} = 10\mu\text{F}$, $C_{OUT} = 47\mu\text{F}$, $C_{NR/SS} = 0\text{nF}$, no C_{FF} , and PG pin pulled up to V_{IN} with $100\text{k}\Omega$, unless otherwise noted.

Output Noise Density vs. Frequency

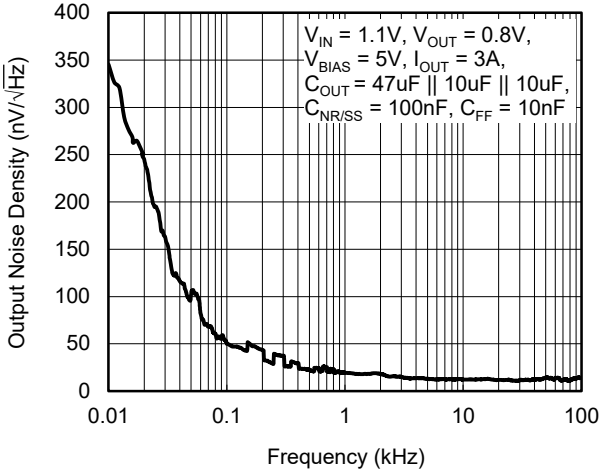

Output Noise Density vs. Frequency

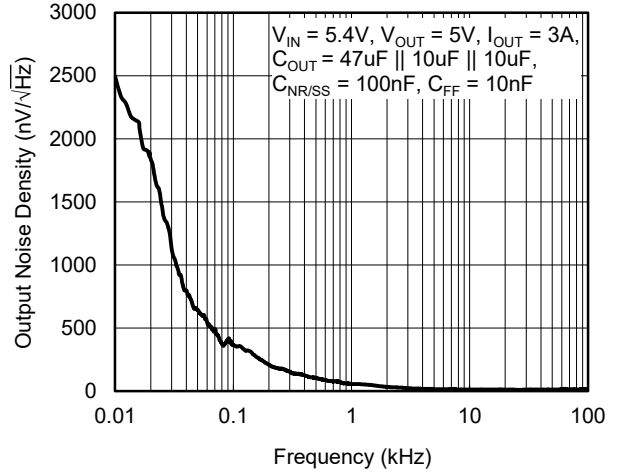

V_{IN} Power Supply Rejection Ratio vs. Frequency

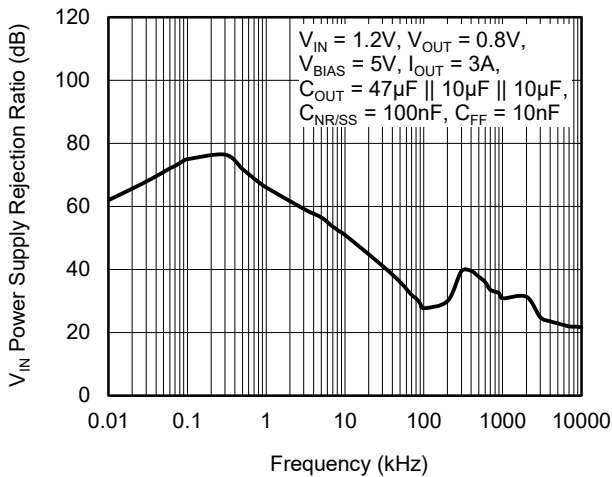

V_{IN} Power Supply Rejection Ratio vs. Frequency

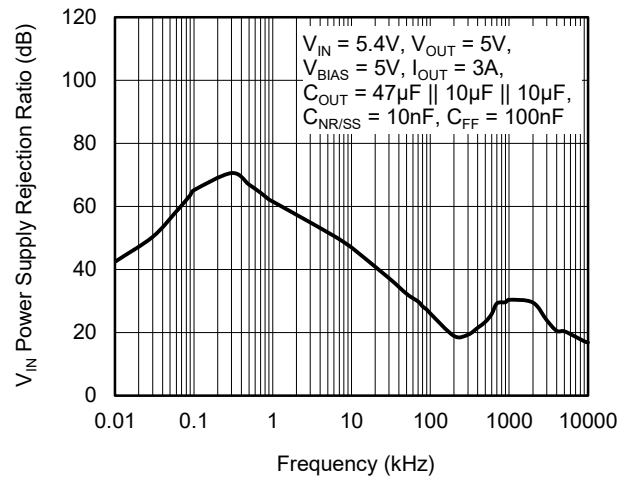

V_{BIAS} Power Supply Rejection Ratio vs. Frequency

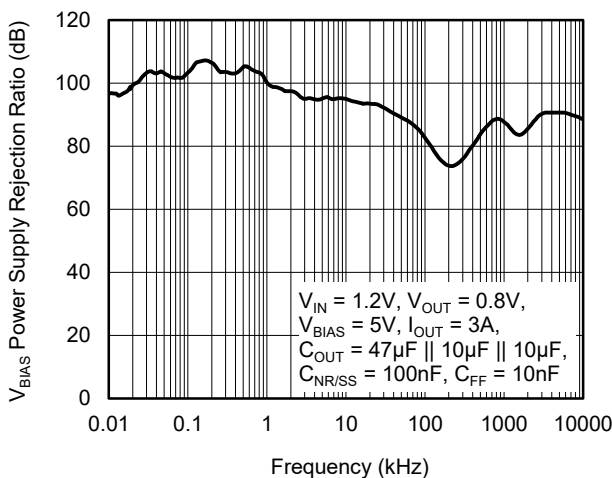

NR/SS Charging Current vs. Input Voltage

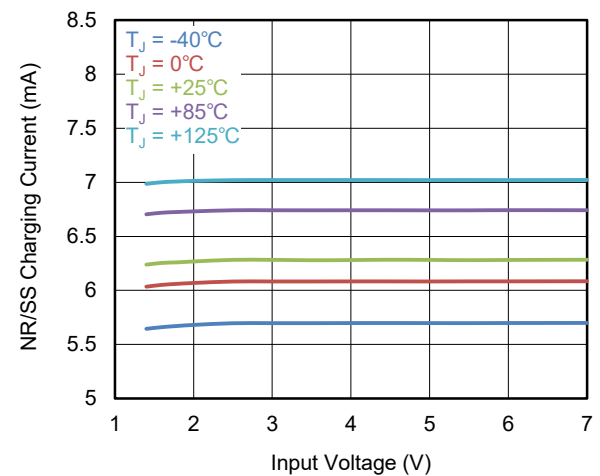

TYPICAL PERFORMANCE CHARACTERISTICS (continued)

$T_J = +25^\circ\text{C}$, $V_{IN} = (V_{OUT(NOM)} + 0.4\text{V})$ or 1.4V (whichever is greater), $V_{BIAS} = \text{Open}$, $V_{OUT(NOM)} = 0.8\text{V}$, $V_{EN} = 1.1\text{V}$, $C_{IN} = 10\mu\text{F}$, $C_{OUT} = 47\mu\text{F}$, $C_{NR/SS} = 0\text{nF}$, no C_{FF} , and PG pin pulled up to V_{IN} with $100\text{k}\Omega$, unless otherwise noted.

Ground Pin Current vs. Input Voltage

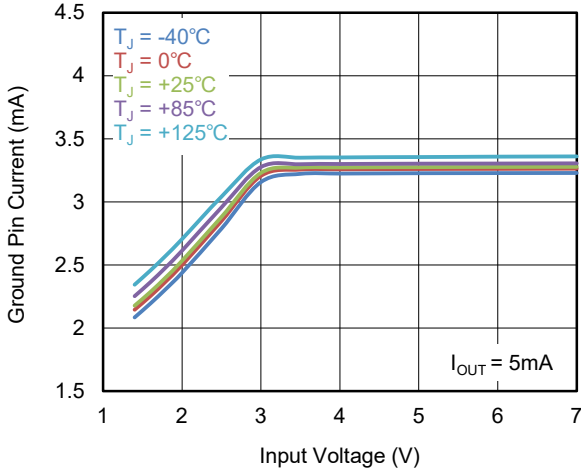

BIAS Pin Current vs. BIAS Voltage

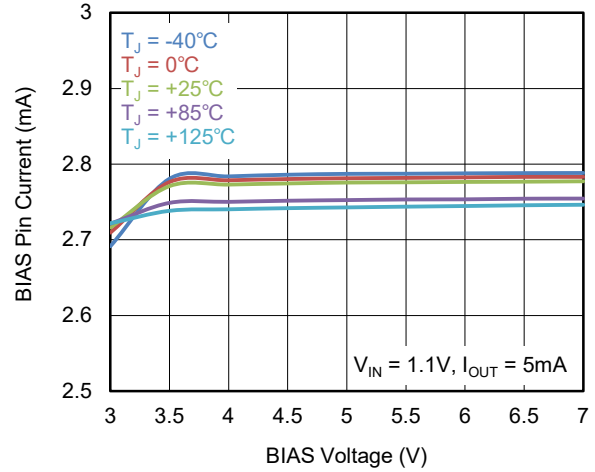

Dropout Voltage vs. Output Current with BIAS

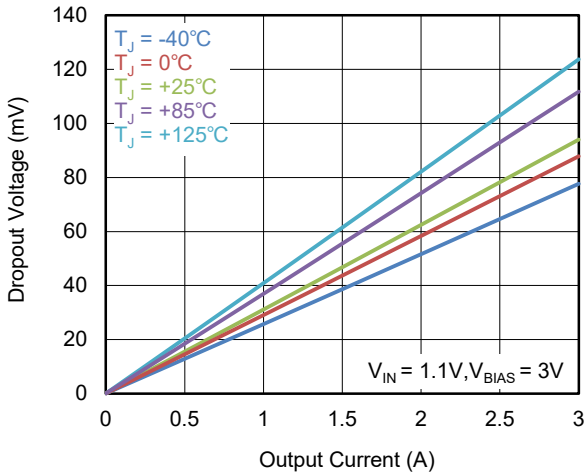

Dropout Voltage vs. Output Current without BIAS

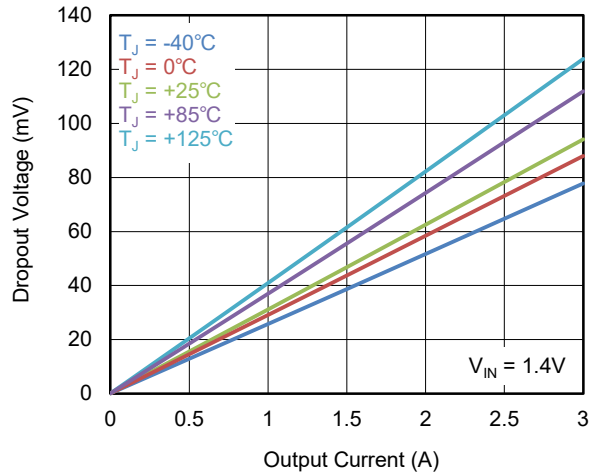

Dropout Voltage vs. Input Voltage with BIAS

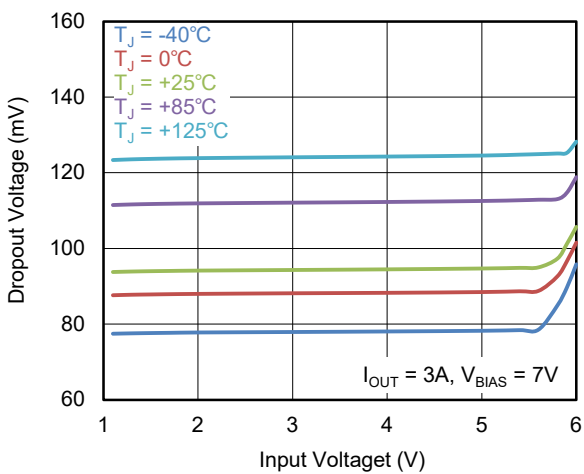

Dropout Voltage vs. Input Voltage without BIAS

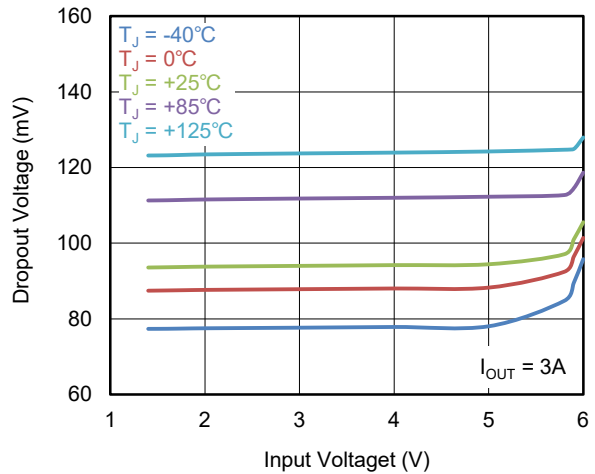

TYPICAL PERFORMANCE CHARACTERISTICS (continued)

$T_J = +25^\circ\text{C}$, $V_{IN} = (V_{OUT(NOM)} + 0.4\text{V})$ or 1.4V (whichever is greater), $V_{BIAS} = \text{Open}$, $V_{OUT(NOM)} = 0.8\text{V}$, $V_{EN} = 1.1\text{V}$, $C_{IN} = 10\mu\text{F}$, $C_{OUT} = 47\mu\text{F}$, $C_{NR/SS} = 0\text{nF}$, no C_{FF} , and PG pin pulled up to V_{IN} with $100\text{k}\Omega$, unless otherwise noted.

Shutdown Current vs. Input Voltage

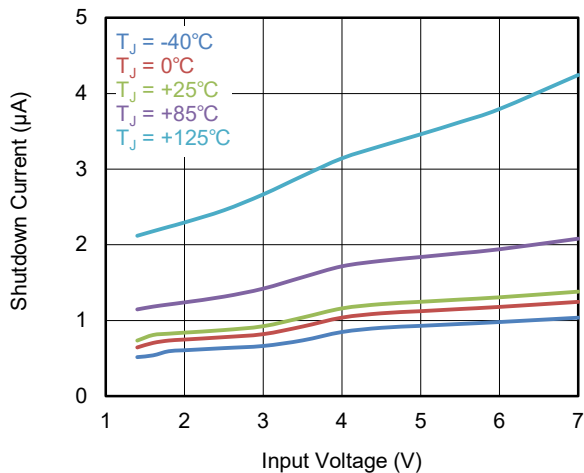

Shutdown Current vs. BIAS Voltage

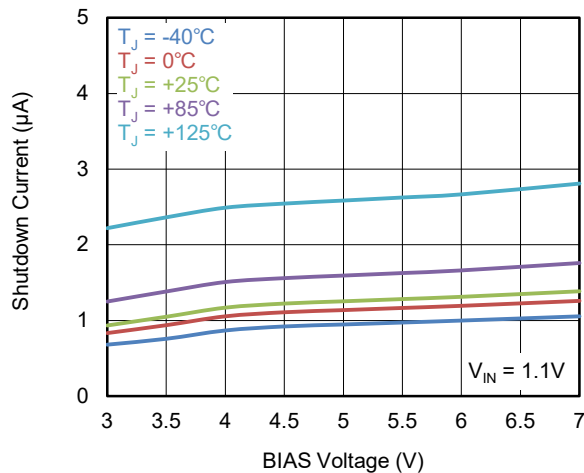

PG Voltage vs. PG Current

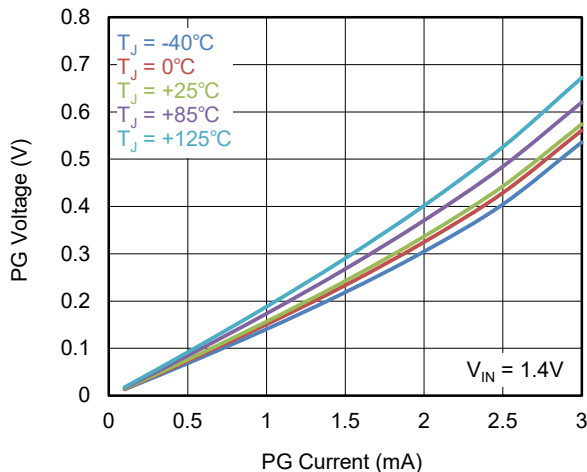

PG Voltage vs. PG Current

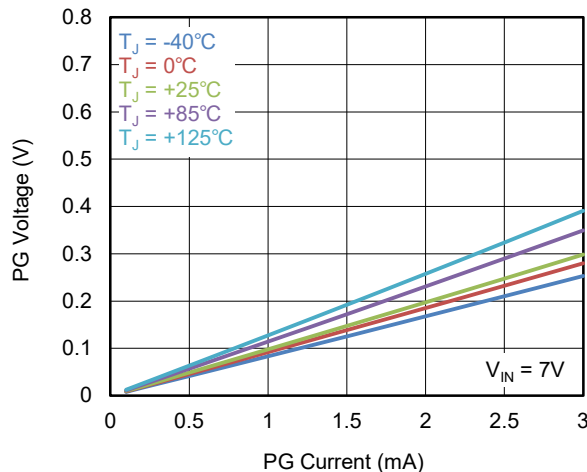

FUNCTIONAL BLOCK DIAGRAM

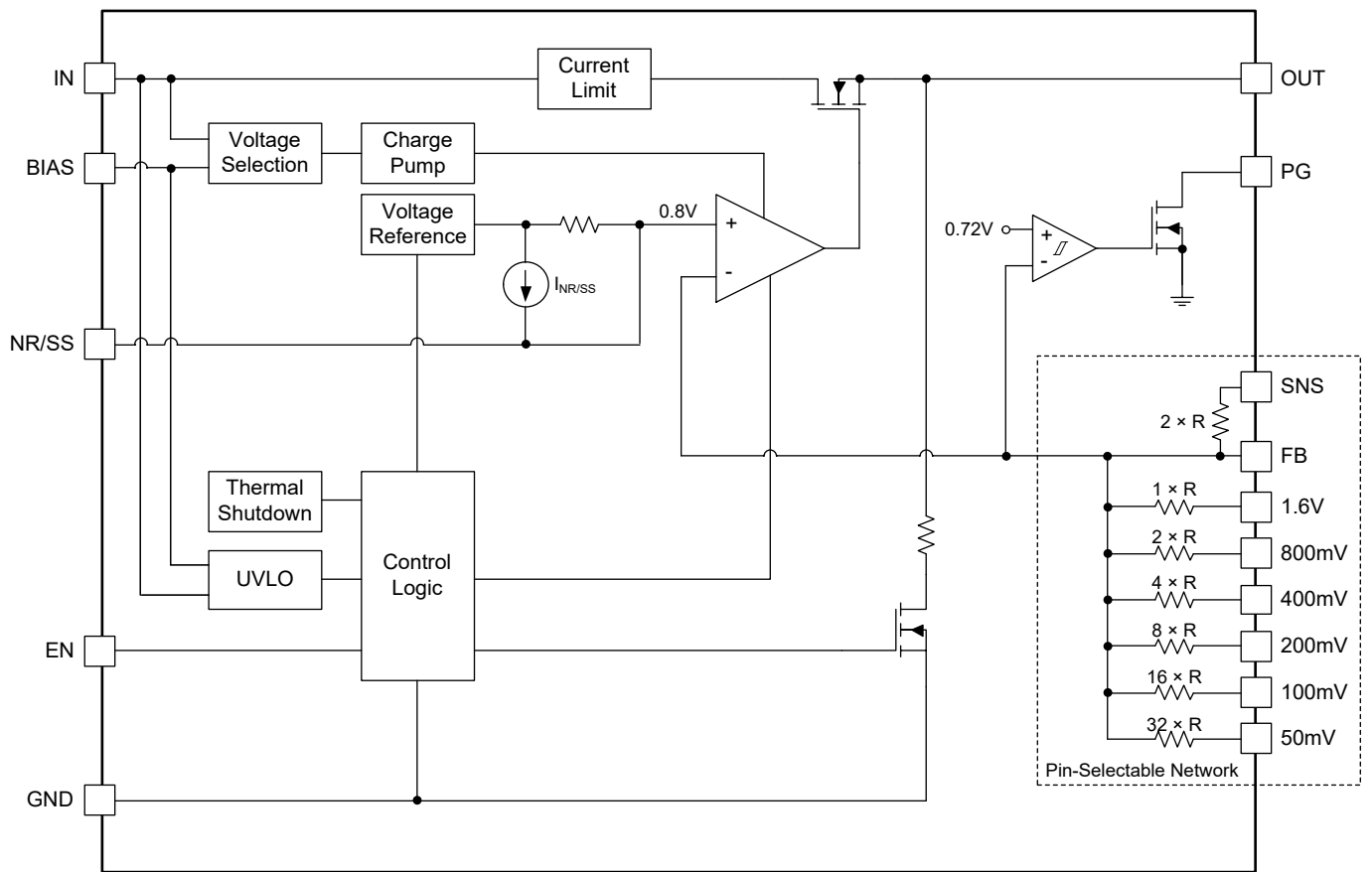

NOTE: For the pin-selectable network, the ratios between the values are highly accurate as a result of matching, but the actual resistance may vary significantly from the numbers listed.

Figure 2. Block Diagram

APPLICATION INFORMATION

The SGM2050 is a high accuracy, low noise, fast transient response high performance LDO, it provides 3A output current. These features make the device a reliable solution to solve many challenging problems in the generation of clean and accurate power supply. The high performance also makes the SGM2050 useful in a variety of applications. The SGM2050 provides the protection function for output overload, output short-circuit condition and overheating.

The SGM2050 provides an EN pin as an external chip enable control to enable/disable the device. When the regulator is in shutdown state, the shutdown current consumes as low as 1.4µA (TYP).

Input Capacitor Selection (C_{IN})

The input decoupling capacitor is necessary to be connected as close as possible to the IN pin for ensuring the device stability. 10µF or greater X7R or X5R ceramic capacitor is selected to get good dynamic performance.

When V_{IN} is required to provide large current instantaneously, a large effective input capacitor is required. Multiple input capacitors can limit the input tracking inductance. Adding more input capacitors is available to restrict the ringing and to keep it below the device absolute maximum ratings.

Output Capacitor Selection (C_{OUT})

The output decoupling capacitor should be located as close as possible to the OUT pin. 10µF or greater X7R or X5R ceramic capacitor is selected to get good dynamic performance. The minimum effective capacitance of C_{OUT} that SGM2050 can remain stable is 10µF. For ceramic capacitor, temperature, DC bias and package size will change the effective capacitance, so enough margin of C_{OUT} must be considered in design. Larger capacitance and lower ESR C_{OUT} will help improve the load transient response and increase the high frequency PSRR.

Feed-Forward Capacitor (C_{FF})

The SGM2050 is designed to be stable without the external feed-forward capacitor (C_{FF}) from the FB pin to the OUT pin, but a 10nF C_{FF} can optimize the transient, noise and PSRR performance. A higher capacitance C_{FF} can also be used; however, the start-up time is

longer and the PG signal may incorrectly indicate that the output voltage has stabilized.

Noise-Reduction and Soft-Start Capacitor (C_{NR/SS})

The SGM2050 is designed for a programmable, monotonic soft-start time of output rising, and it can be achieved via an external capacitor (C_{NR/SS}) on the NR/SS pin. Using an external C_{NR/SS} is recommended for general application. It not only minimizes the inrush current but also helps reduce the noise component from internal reference.

Adjustable Output Voltage

The SGM2050 can be set either with the internal pin-selectable network or by connecting with external resistors to achieve different output voltages. When the output voltage range is from 0.8V to 3.95V, the SGM2050 can be programmed by using the pin-selectable network. When the output voltage range is greater than 3.95V and up to 5.2V, external resistors must be used. The output voltage is determined by two resistors as shown in Figure 3.

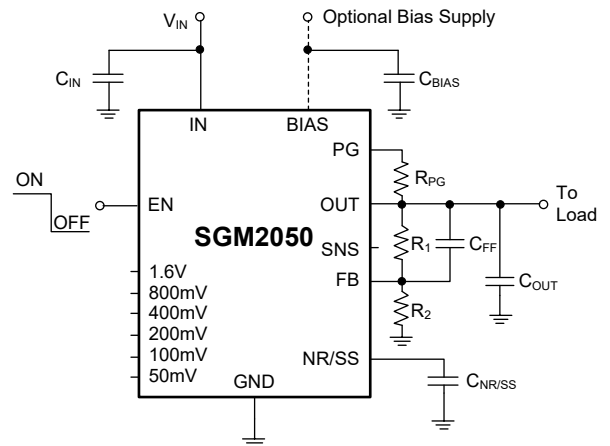

Figure 3. Adjustable Output Voltage Application

R₁ and R₂ can be calculated for any output voltage range using Equation 1. This resistive network must provide a current equal to or greater than 5µA for DC accuracy. It is recommended to use an R₁ approximately 12kΩ to optimize the noise and PSRR.

$$V_{OUT} = 0.8V \times \left(1 + \frac{R_1}{R_2} \right) \tag{1}$$

APPLICATION INFORMATION (continued)

Pin-Selectable Programmable Output Voltage

Pin-selectable programmable output voltage is achieved with the pin-selectable resistors via pin 2 and pins 5 to 11. Each pin can be grounded (active) or floating (open) or connected to the SNS pin. Pin-selectable programming is set as the internal reference voltage by Equation 2 plus the accumulated sum of the respective voltages assigned to each active pin. Table 1 shows these voltage values related to each active pin setting for reference.

$$V_{OUT} = 0.8V + (\Sigma \text{ Pin-Selectable Pins to Ground}) \quad (2)$$

Table 1. Pin-Selectable Programmable Output Voltage

Pin-Selectable Program Pins (Active Low)	Additive Output Voltage Level
Pin 5 (50mV)	50mV
Pin 6 (100mV)	100mV
Pin 7 (200mV)	200mV
Pin 9 (400mV)	400mV
Pin 10 (800mV)	800mV
Pin 11 (1.6V)	1.6V

The output voltage is set according to Equation 1 as for the adjustable operation, but R_1 and R_2 are internally integrated and matched for higher accuracy. By reducing the value of R_1 and connecting any of the pin-selectable pins to the SNS pin, the resolution of the internal feedback network can be improved.

Enable Control

The SGM2050 uses the EN pin to enable/disable the device and to deactivate/activate the output automatic discharge function.

When the EN pin voltage is lower than $V_{IL(EN)}$, the device is in shutdown state, there is no current flowing from IN to OUT pins. In this state, the automatic discharge transistor is active to discharge the output voltage through a 260 Ω (TYP) resistor.

When the EN pin voltage is higher than $V_{IH(EN)}$, the device is in active state, the input voltage is regulated to the output voltage and the automatic discharge transistor is turned off.

Output Current Limit and Short-Circuit Protection

When overload events happen, the output current is internally limited to 4.1A (TYP). When the OUT pin is

shorted to ground, the short-circuit protection will limit the output current to 2A (TYP).

Thermal Shutdown

The SGM2050 can detect the temperature of die. When the die temperature exceeds the threshold value of thermal shutdown, the SGM2050 will be in shutdown state and it will remain in this state until the die temperature decreases to +140°C.

Power Dissipation (P_D)

Thermal protection limits power dissipation in the SGM2050. When power dissipation on pass element ($P_D = (V_{IN} - V_{OUT}) \times I_{OUT}$) is too much that raise the operation junction temperature exceeds +165°C, the OTP circuit starts the thermal shutdown function and turns the pass element off.

Therefore, thermal analysis for the chosen application is important to guarantee reliable performance over all conditions. To guarantee reliable operation, the junction temperature of the SGM2050 must not exceed +125°C.

The maximum allowable power dissipation depends on the thermal resistance of the IC package, the PCB layout, the rate of surrounding airflow, and the difference between the junction and ambient temperatures. The maximum power dissipation can be approximated using the following formula:

$$P_{D(MAX)} = (T_{J(MAX)} - T_A) / \theta_{JA} \quad (3)$$

where $T_{J(MAX)}$ is the maximum junction temperature, T_A is the ambient temperature, and θ_{JA} is the junction -to-ambient thermal resistance.

Negatively Biased Output

When the output is negative voltage, the chip may not start up due to parasitic effects. Ensure that the output is greater than -0.3V under all conditions. If excessive negatively biased output is expected in the application, a Schottky diode can be added between the OUT pin and GND pin.

Reverse Current Protection

The pass transistor has an inherent body diode which will be forward biased in the case when $V_{OUT} > (V_{IN} + 0.3V)$. If extended reverse voltage operation is anticipated, external limiting might be appropriate.

PACKAGE INFORMATION

PACKAGE OUTLINE DIMENSIONS

TQFN-3.5x3.5-20L

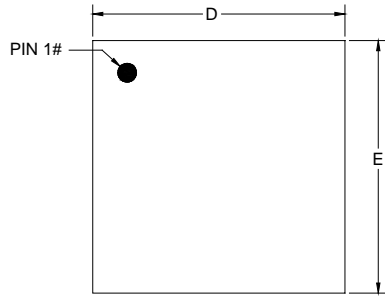

TOP VIEW

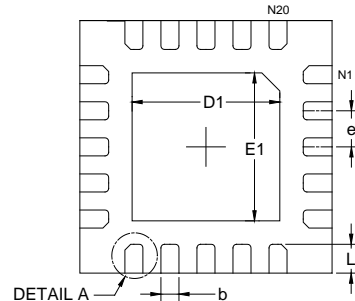

BOTTOM VIEW

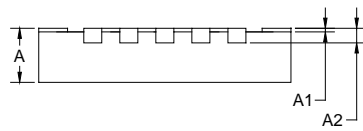

SIDE VIEW

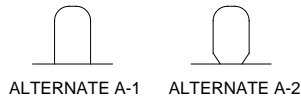

DETAIL A
ALTERNATE TERMINAL
CONSTRUCTION

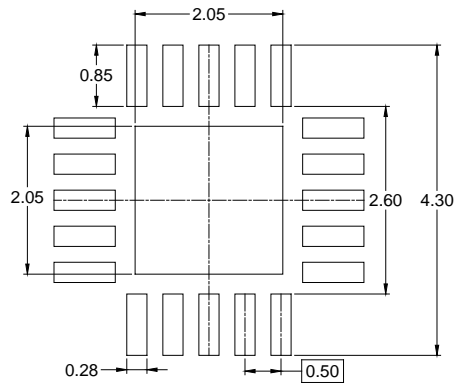

RECOMMENDED LAND PATTERN (Unit: mm)

Symbol	Dimensions In Millimeters		
	MIN	MOD	MAX
A	0.700	0.750	0.800
A1	-	-	0.050
A2	0.203 REF		
D	3.450	3.500	3.550
D1	2.000	2.050	2.100
E	3.450	3.500	3.550
E1	2.000	2.050	2.100
b	0.200	0.250	0.300
e	0.500 BSC		
L	0.350	0.400	0.450

NOTE: This drawing is subject to change without notice.

PACKAGE INFORMATION

TAPE AND REEL INFORMATION

REEL DIMENSIONS

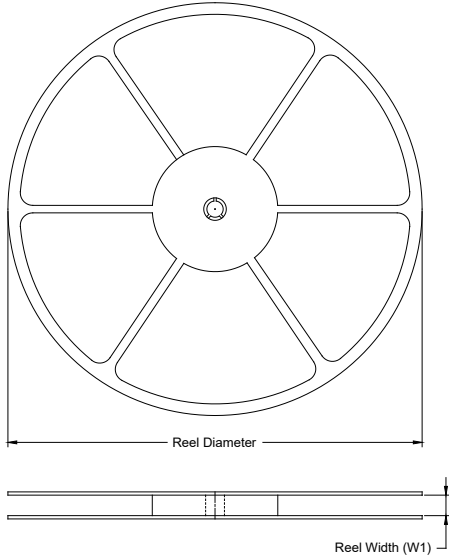

TAPE DIMENSIONS

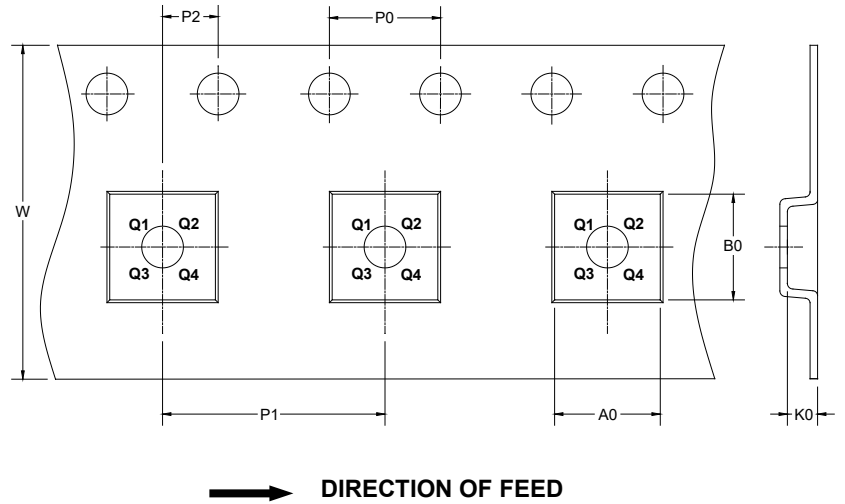

NOTE: The picture is only for reference. Please make the object as the standard.

KEY PARAMETER LIST OF TAPE AND REEL

Package Type	Reel Diameter	Reel Width W1 (mm)	A0 (mm)	B0 (mm)	K0 (mm)	P0 (mm)	P1 (mm)	P2 (mm)	W (mm)	Pin1 Quadrant
TQFN-3.5×3.5-20L	13"	12.4	3.80	3.80	0.95	4.0	8.0	2.0	12.0	Q2

DD0001

PACKAGE INFORMATION

CARTON BOX DIMENSIONS



NOTE: The picture is only for reference. Please make the object as the standard.

KEY PARAMETER LIST OF CARTON BOX

Reel Type	Length (mm)	Width (mm)	Height (mm)	Pizza/Carton
13"	386	280	370	5

DD0002