



# SGM8040-1/SGM8040-2 550nA, Rail-to-Rail I/O, High Precision Operational Amplifiers

## GENERAL DESCRIPTION

The high precision single SGM8040-1 and dual SGM8040-2 operational amplifiers are guaranteed to operate with a single supply voltage as low as 1.4V, while drawing 550nA/Amplifier (TYP) of quiescent current. These devices are also designed to support rail-to-rail input and output operation. This combination of features supports battery-powered and portable applications.

The SGM8040-1/2 have a gain-bandwidth product of 11kHz (TYP) and are unity gain stable. These specifications make the operational amplifiers appropriate for low frequency applications, such as battery current monitoring and sensor conditioning.

The single SGM8040-1 is available in Green SOT-23-5, SC70-5 and SOIC-8 packages. The dual SGM8040-2 is available in Green SOIC-8 and TDFN-2×2-8L packages. They operate over an ambient temperature range of -40°C to +85°C.

## FEATURES

- **Low Quiescent Current: 550nA/Amplifier (TYP)**
- **Rail-to-Rail Input and Output**
- **Gain-Bandwidth Product: 11kHz (TYP)**
- **Wide Supply Voltage Range: 1.4V to 5.5V**
- **Unity Gain Stable**
- **Low Offset Voltage: 230µV (MAX)**
- **-40°C to +85°C Operating Temperature Range**
- **Small Packages:**
  - SGM8040-1 Available in Green SOT-23-5, SC70-5 and SOIC-8 Packages
  - SGM8040-2 Available in Green TDFN-2×2-8L and SOIC-8 Packages

## APPLICATIONS

- Toll Booth Tags
- Wearable Products
- Temperature Measurements
- Battery Powered Systems

## TYPICAL APPLICATION

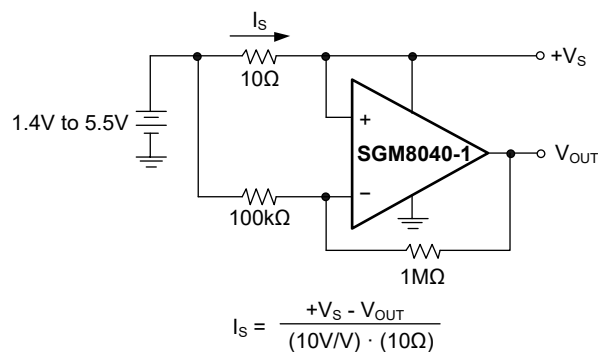

$$I_s = \frac{+V_S - V_{OUT}}{(10V/V) \cdot (10\Omega)}$$

High-side Battery Current Sensor

**PACKAGE/ORDERING INFORMATION**

MODEL	PACKAGE DESCRIPTION	SPECIFIED TEMPERATURE RANGE	ORDERING NUMBER	PACKAGE MARKING	PACKING OPTION
SGM8040-1	SOT-23-5	-40°C to +85°C	SGM8040-1YN5G/TR	GP0XX	Tape and Reel, 3000
	SC70-5	-40°C to +85°C	SGM8040-1YC5G/TR	GY3XX	Tape and Reel, 3000
	SOIC-8	-40°C to +85°C	SGM8040-1YS8G/TR	SGM 80401YS8 XXXXX	Tape and Reel, 4000
SGM8040-2	SOIC-8	-40°C to +85°C	SGM8040-2YS8G/TR	SGM 80402YS8 XXXXX	Tape and Reel, 4000
	TDFN-2x2-8L	-40°C to +85°C	SGM8040-2YTDE8G/TR	GXF XXXX	Tape and Reel, 3000

**MARKING INFORMATION**

NOTE: XX = Date Code. XXXX = Date Code. XXXXX = Date Code and Vendor Code.

**SOT-23-5/SC70-5**

**GYX X X**

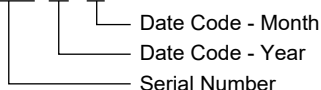

**SOIC-8**

**XXXXX**

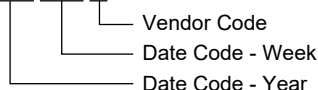

**TDFN-2x2-8L**

**GXF** — Serial Number

**XXX**

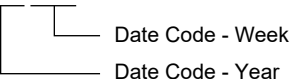

Green (RoHS & HSF): SG Micro Corp defines "Green" to mean Pb-Free (RoHS compatible) and free of halogen substances. If you have additional comments or questions, please contact your SGMICRO representative directly.

# SGM8040-1 SGM8040-2

# 550nA, Rail-to-Rail I/O, High Precision Operational Amplifiers

## ABSOLUTE MAXIMUM RATINGS

Supply Voltage.....	6V
Analog Inputs ( $V_{IN+}$ , $V_{IN-}$ ).....	$(-V_S) - 0.3V$ to $(+V_S) + 0.3V$
Differential Input Voltage.....	$ (-V_S) - (+V_S) $
Junction Temperature.....	+150°C
Storage Temperature Range.....	-65°C to +150°C
Lead Temperature (Soldering, 10s).....	+260°C
ESD Susceptibility	
HBM.....	8000V
MM.....	400V
CDM.....	1000V

## RECOMMENDED OPERATING CONDITIONS

Operating Temperature Range.....	-40°C to +85°C
----------------------------------	----------------

## OVERSTRESS CAUTION

Stresses beyond those listed in Absolute Maximum Ratings may cause permanent damage to the device. Exposure to absolute maximum rating conditions for extended periods may affect reliability. Functional operation of the device at any conditions beyond those indicated in the Recommended Operating Conditions section is not implied.

## ESD SENSITIVITY CAUTION

This integrated circuit can be damaged by ESD if you don't pay attention to ESD protection. SGMICRO recommends that all integrated circuits be handled with appropriate precautions. Failure to observe proper handling and installation procedures can cause damage. ESD damage can range from subtle performance degradation to complete device failure. Precision integrated circuits may be more susceptible to damage because very small parametric changes could cause the device not to meet its published specifications.

## DISCLAIMER

SG Micro Corp reserves the right to make any change in circuit design, or specifications without prior notice.

## PIN CONFIGURATIONS

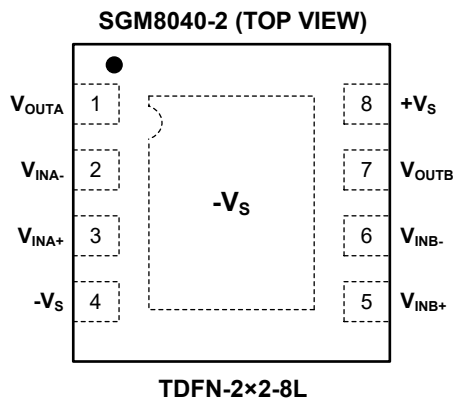
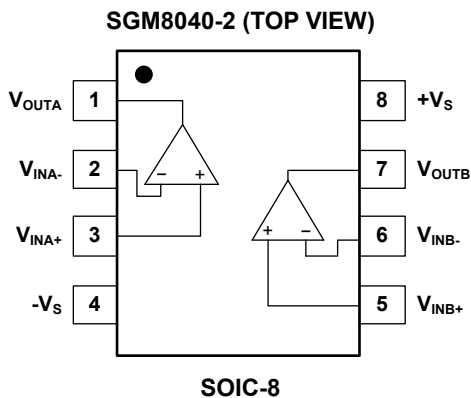
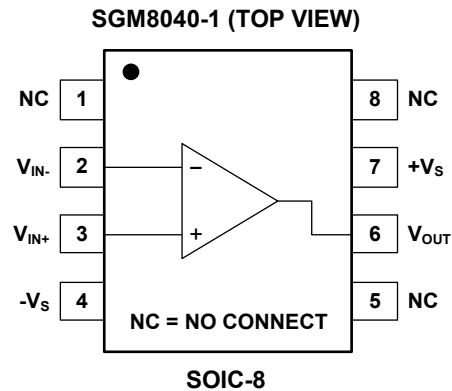
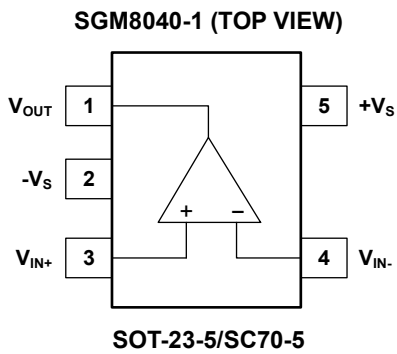

## ELECTRICAL CHARACTERISTICS

(At  $T_A = +25^\circ\text{C}$ , Full =  $-40^\circ\text{C}$  to  $+85^\circ\text{C}$ ,  $V_S = \pm 0.7\text{V}$  to  $\pm 2.75\text{V}$  and  $R_L = 1\text{M}\Omega$  <sup>(1)</sup> connected to 0V, unless otherwise noted.)

PARAMETER	SYMBOL	CONDITIONS	TEMP	MIN	TYP	MAX	UNITS
<b>DC ELECTRICAL CHARACTERISTICS</b>							
Input Offset Voltage	$V_{OS}$	$V_{CM} = 0\text{V}$	+25°C		80	230	$\mu\text{V}$
			Full			530	
Input Offset Voltage Drift	$\Delta V_{OS}/\Delta T$		Full		1		$\mu\text{V}/^\circ\text{C}$
Input Bias Current	$I_B$	$V_{CM} = 0\text{V}$	+25°C		$\pm 10$	$\pm 200$	pA
Input Offset Current	$I_{OS}$	$V_{CM} = 0\text{V}$	+25°C		$\pm 10$	$\pm 300$	pA
Input Common Mode Voltage Range	$V_{CM}$		Full	$(-V_S) - 0.1$		$(+V_S) + 0.1$	V
Common Mode Rejection Ratio	CMRR	$V_S = \pm 2.5\text{V}, (-V_S) - 0.1\text{V} < V_{CM} < (+V_S) + 0.1\text{V}$	+25°C	82	92		dB
			Full	75			
		$V_S = \pm 2.5\text{V}, 0 < V_{CM} < (+V_S) + 0.1\text{V}$	+25°C	76	86		
			Full	70			
		$V_S = \pm 2.5\text{V}, (-V_S) - 0.1\text{V} < V_{CM} < 0$	+25°C	90	110		
			Full	86			
Open-Loop Voltage Gain	$A_{OL}$	$V_S = \pm 0.7\text{V}, (-V_S) + 0.1\text{V} < V_{OUT} < (+V_S) - 0.1\text{V}, R_L = 50\text{k}\Omega$	+25°C	88	110		dB
			Full	85			
		$V_S = \pm 2.5\text{V}, (-V_S) + 0.1\text{V} < V_{OUT} < (+V_S) - 0.1\text{V}, R_L = 50\text{k}\Omega$	+25°C	104	120		
			Full	94			
Output Voltage Swing from Rail		$R_L = 50\text{k}\Omega$	+25°C		3	9	mV
			Full			10	
Output Short-Circuit Current	$I_{SC}$	$V_S = \pm 0.7\text{V}$	+25°C		2		mA
		$V_S = \pm 2.5\text{V}$	+25°C	8	18		
Supply Voltage	$V_S$		Full	1.4		5.5	V
Quiescent Current/Amplifier	$I_Q$		+25°C		550	850	nA
			Full			900	
Power Supply Rejection Ratio	PSRR	$V_S = 1.4\text{V to } 5.5\text{V}$	+25°C	86	104		dB
			Full	82			
<b>AC ELECTRICAL CHARACTERISTICS</b>							
Gain-Bandwidth Product	GBP	$C_L = 60\text{pF}$	+25°C		11		kHz
Slew Rate	SR	$V_S = \pm 0.7\text{V}, V_{OUT} = 1V_{P-P}, G = +1$	+25°C		2		V/ms
		$V_S = \pm 1.25\text{V}, V_{OUT} = 1V_{P-P}, G = +1$	+25°C		3.5		
		$V_S = \pm 2.5\text{V}, V_{OUT} = 2V_{P-P}, G = +1$	+25°C		4		
Input Voltage Noise		$f = 0.1\text{Hz to } 10\text{Hz}$	+25°C		5		$\mu\text{V}_{P-P}$
Input Voltage Noise Density	$e_n$	$f = 1\text{kHz}$	+25°C		180		$\text{nV}/\sqrt{\text{Hz}}$
Input Current Noise Density	$i_n$	$f = 1\text{kHz}$	+25°C		300		$\text{fA}/\sqrt{\text{Hz}}$

NOTE: 1. Refer to Figure 1 and Figure 2.

**TYPICAL PERFORMANCE CHARACTERISTICS**

At  $T_A = +25^\circ\text{C}$ ,  $V_S = 5\text{V}$ ,  $R_L = 1\text{M}\Omega$ , unless otherwise noted.

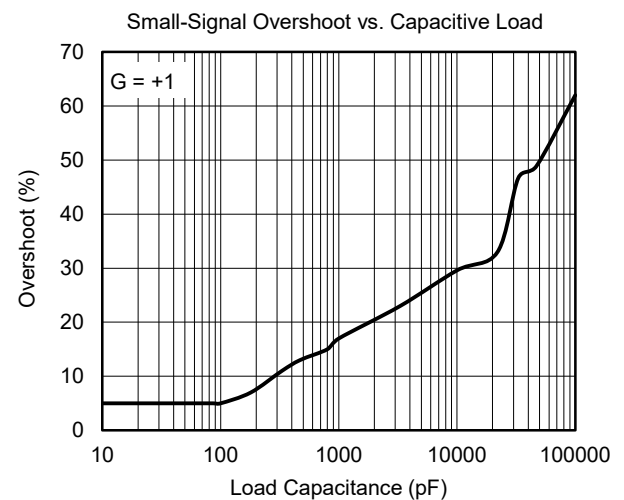
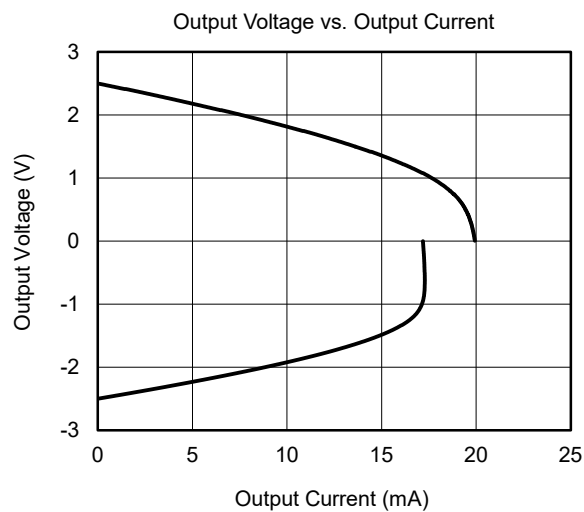
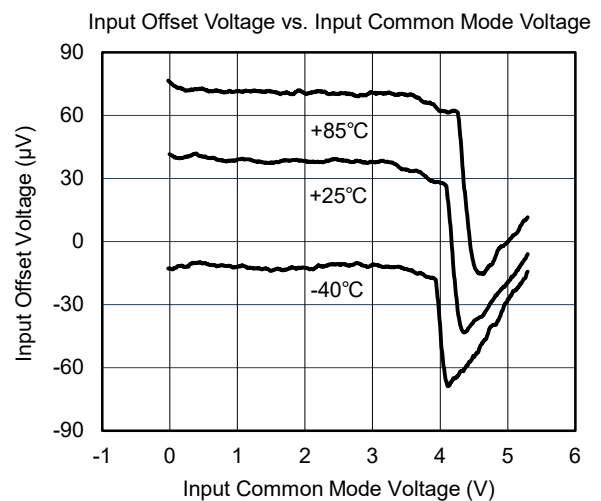
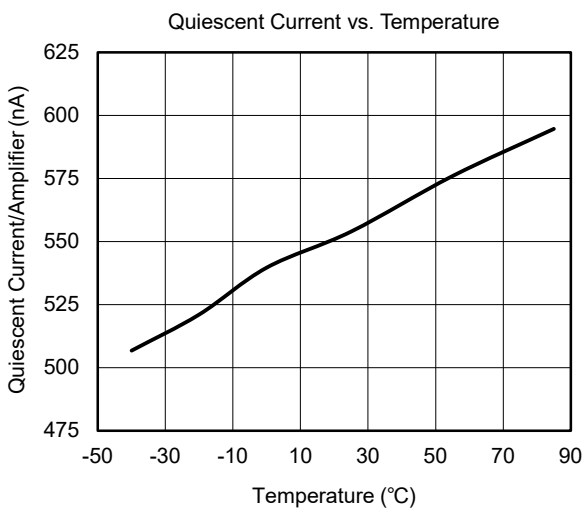
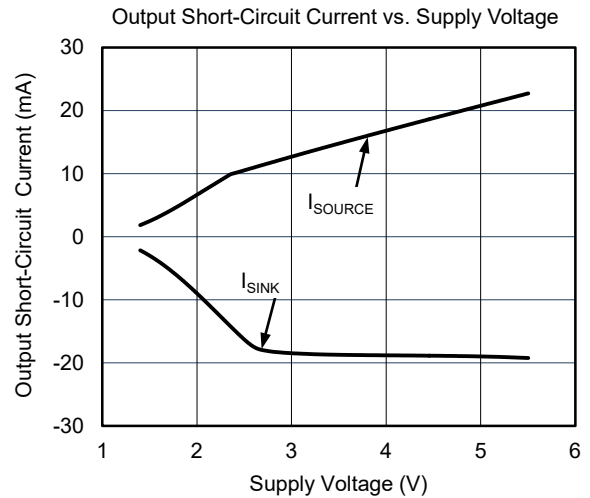
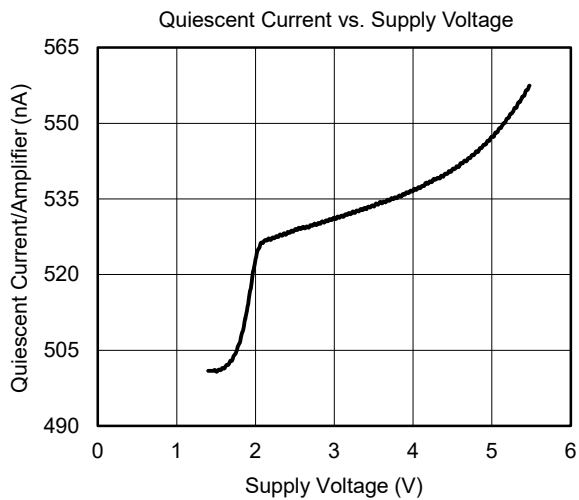

**TYPICAL PERFORMANCE CHARACTERISTICS (continued)**

At  $T_A = +25^\circ\text{C}$ ,  $V_S = 5\text{V}$ ,  $R_L = 1\text{M}\Omega$ , unless otherwise noted.

Large-Signal Step Response

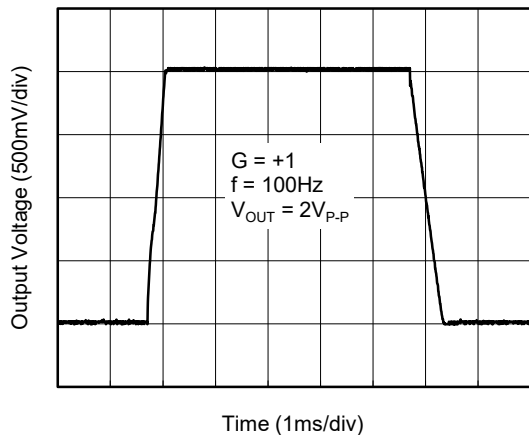

Small-Signal Step Response

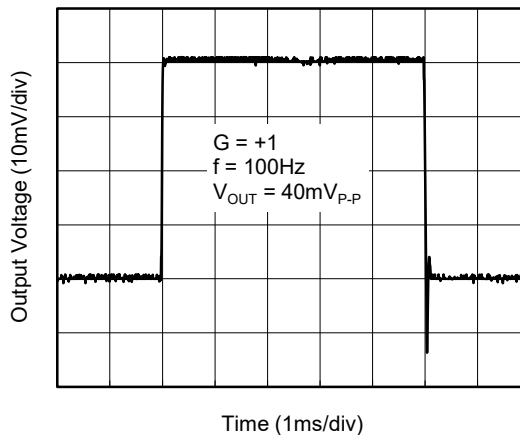

CMRR and PSRR vs. Frequency

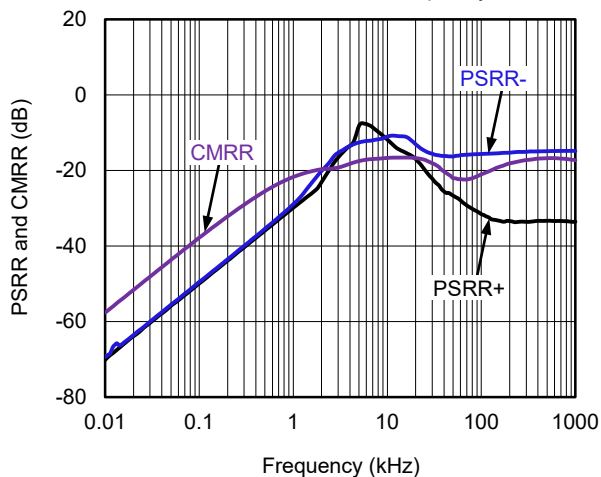

Open-Loop Gain and Phase vs. Frequency

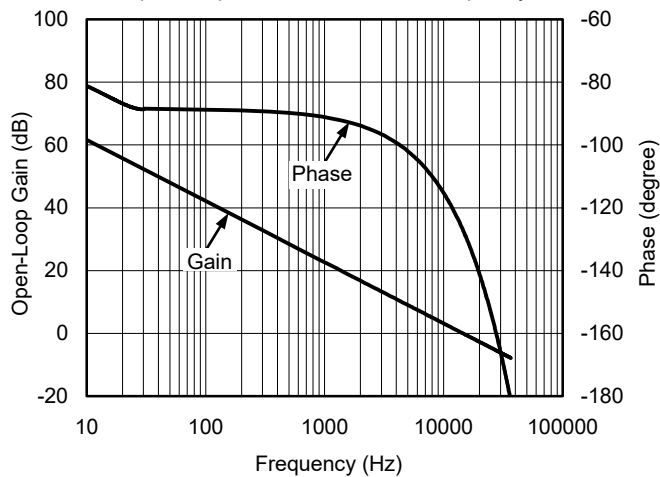

Maximum Output Voltage vs. Frequency

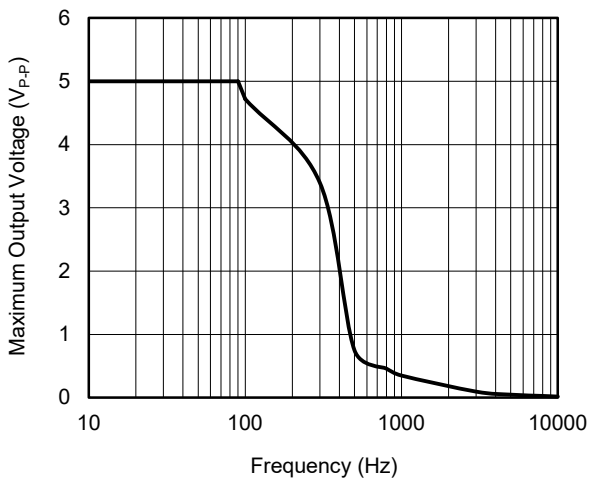

Input Voltage Noise Density vs. Frequency

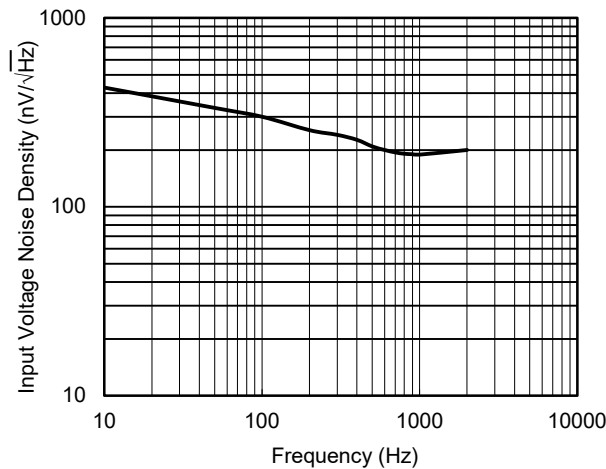

**TYPICAL PERFORMANCE CHARACTERISTICS (continued)**

At  $T_A = +25^\circ\text{C}$ ,  $V_S = 5\text{V}$ ,  $R_L = 1\text{M}\Omega$ , unless otherwise noted.

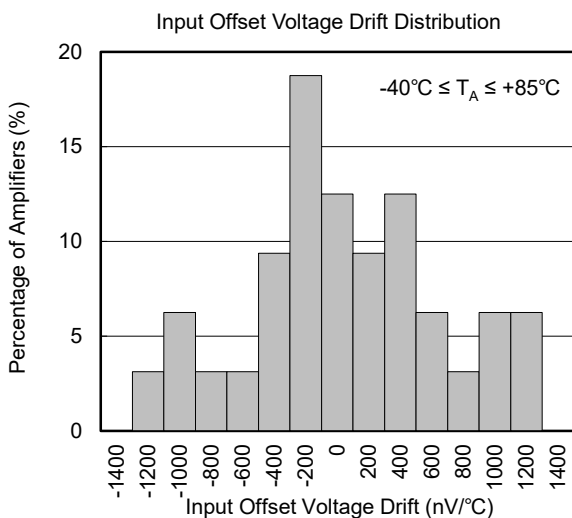
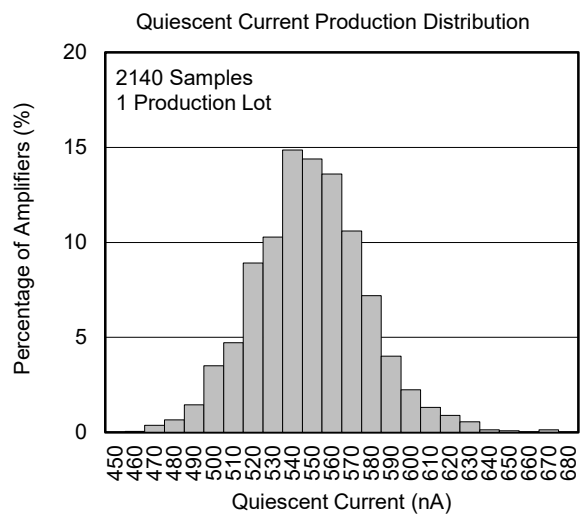
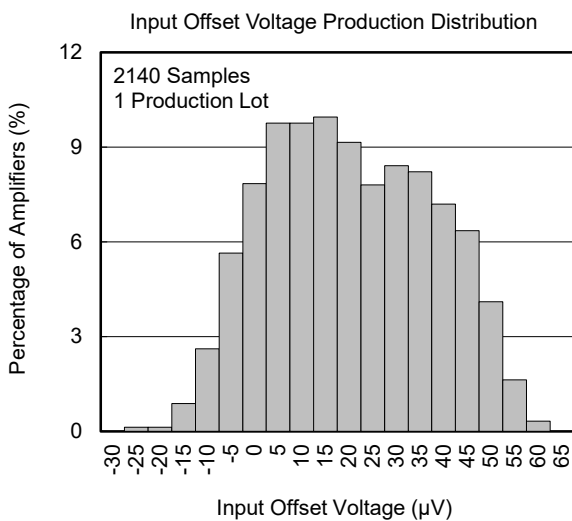
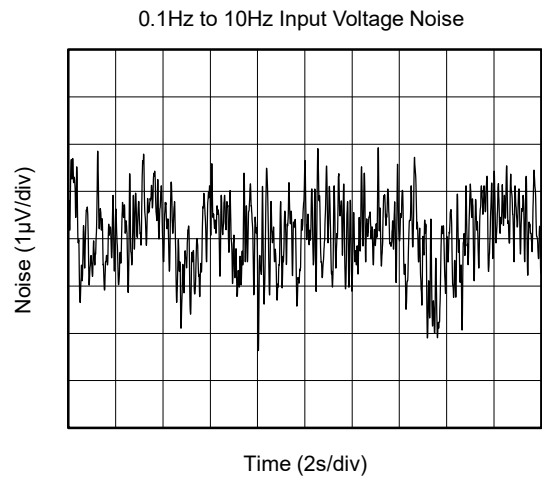
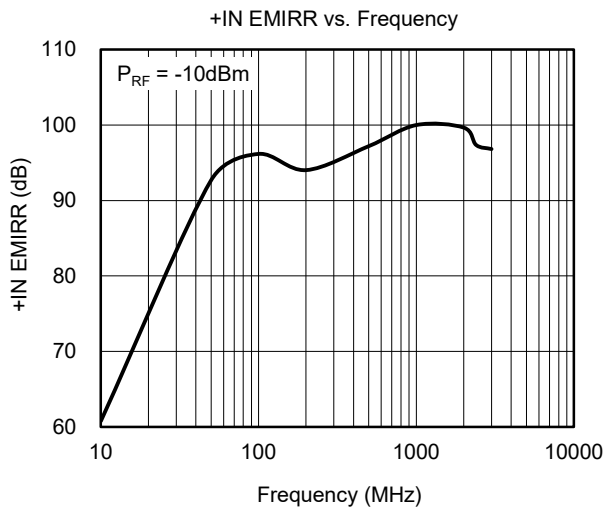

**TEST CIRCUITS**

The test circuits used for the DC and AC tests are shown in Figure 1 and Figure 2.

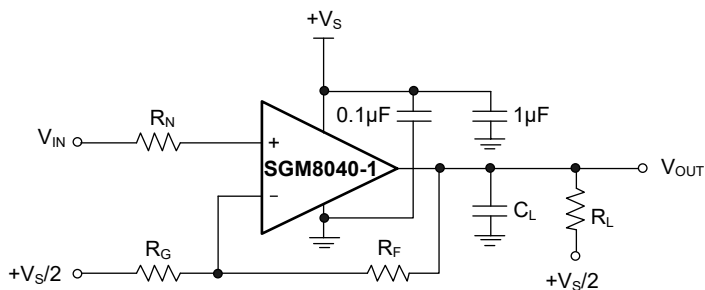

**Figure 1. AC and DC Test Circuit for Most Non-Inverting Gain Configurations**

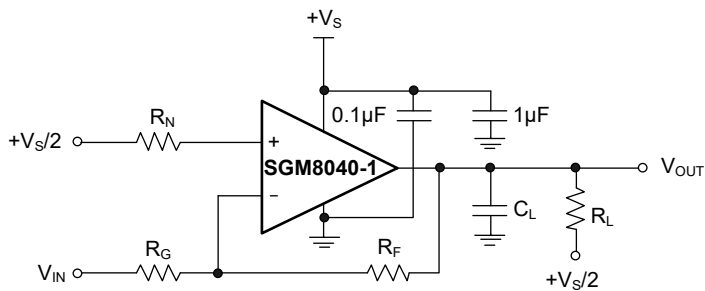

**Figure 2. AC and DC Test Circuit for Most Inverting Gain Configurations**

**REVISION HISTORY**

NOTE: Page numbers for previous revisions may differ from page numbers in the current version.

**Changes from Original (SEPTEMBER 2018) to REV.A**

---

Changed from product preview to production data.....	All
--	-----

---



# PACKAGE INFORMATION

## PACKAGE OUTLINE DIMENSIONS

### SOT-23-5

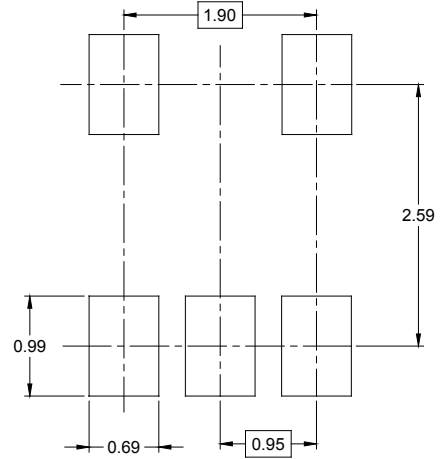
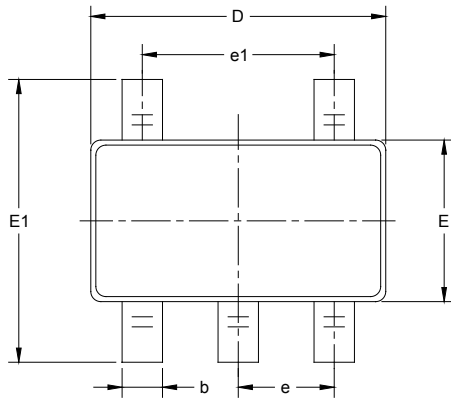

RECOMMENDED LAND PATTERN (Unit: mm)

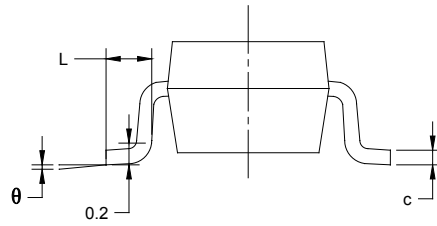
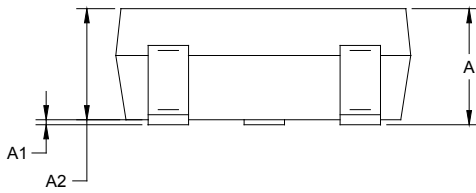

Symbol	Dimensions In Millimeters		Dimensions In Inches	
	MIN	MAX	MIN	MAX
A	1.050	1.250	0.041	0.049
A1	0.000	0.100	0.000	0.004
A2	1.050	1.150	0.041	0.045
b	0.300	0.500	0.012	0.020
c	0.100	0.200	0.004	0.008
D	2.820	3.020	0.111	0.119
E	1.500	1.700	0.059	0.067
E1	2.650	2.950	0.104	0.116
e	0.950 BSC		0.037 BSC	
e1	1.900 BSC		0.075 BSC	
L	0.300	0.600	0.012	0.024
$\theta$	0°	8°	0°	8°

# PACKAGE INFORMATION

## PACKAGE OUTLINE DIMENSIONS

### SC70-5

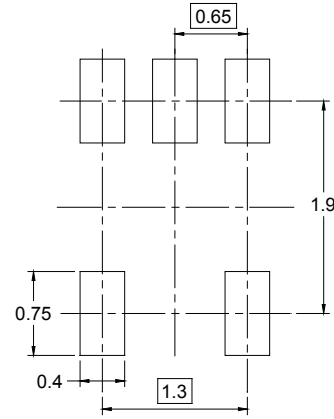
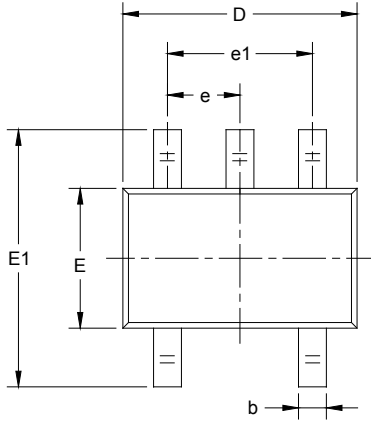

RECOMMENDED LAND PATTERN (Unit: mm)

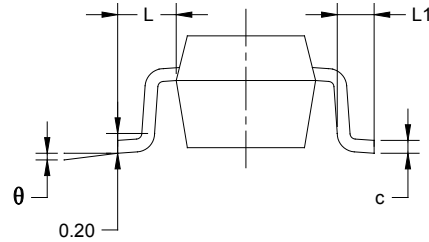
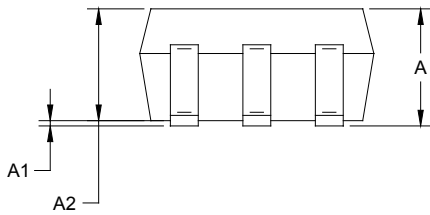

Symbol	Dimensions In Millimeters		Dimensions In Inches	
	MIN	MAX	MIN	MAX
A	0.900	1.100	0.035	0.043
A1	0.000	0.100	0.000	0.004
A2	0.900	1.000	0.035	0.039
b	0.150	0.350	0.006	0.014
c	0.080	0.150	0.003	0.006
D	2.000	2.200	0.079	0.087
E	1.150	1.350	0.045	0.053
E1	2.150	2.450	0.085	0.096
e	0.65 TYP		0.026 TYP	
e1	1.300 BSC		0.051 BSC	
L	0.525 REF		0.021 REF	
L1	0.260	0.460	0.010	0.018
$\theta$	0°	8°	0°	8°

# PACKAGE INFORMATION

## PACKAGE OUTLINE DIMENSIONS

### TDFN-2×2-8L

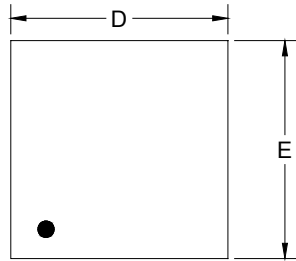

TOP VIEW

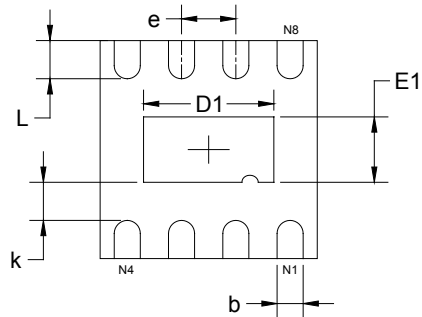

BOTTOM VIEW

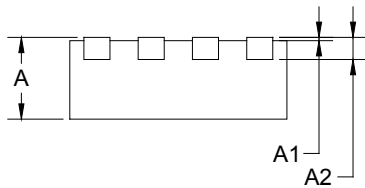

SIDE VIEW

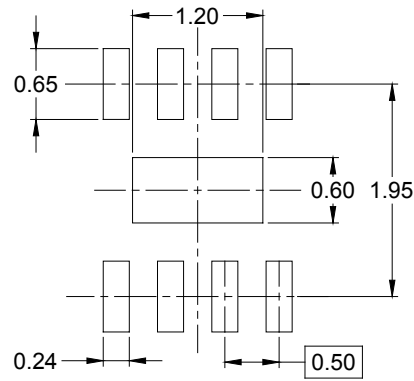

RECOMMENDED LAND PATTERN (Unit: mm)

Symbol	Dimensions In Millimeters		Dimensions In Inches	
	MIN	MAX	MIN	MAX
A	0.700	0.800	0.028	0.031
A1	0.000	0.050	0.000	0.002
A2	0.203 REF		0.008 REF	
D	1.900	2.100	0.075	0.083
D1	1.100	1.300	0.043	0.051
E	1.900	2.100	0.075	0.083
E1	0.500	0.700	0.020	0.028
k	0.200 MIN		0.008 MIN	
b	0.180	0.300	0.007	0.012
e	0.500 TYP		0.020 TYP	
L	0.250	0.450	0.010	0.018

# PACKAGE INFORMATION

## PACKAGE OUTLINE DIMENSIONS

### SOIC-8

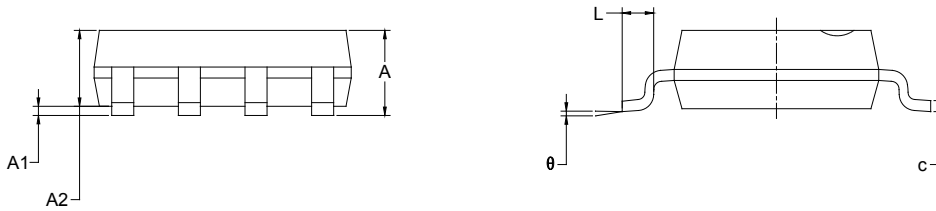
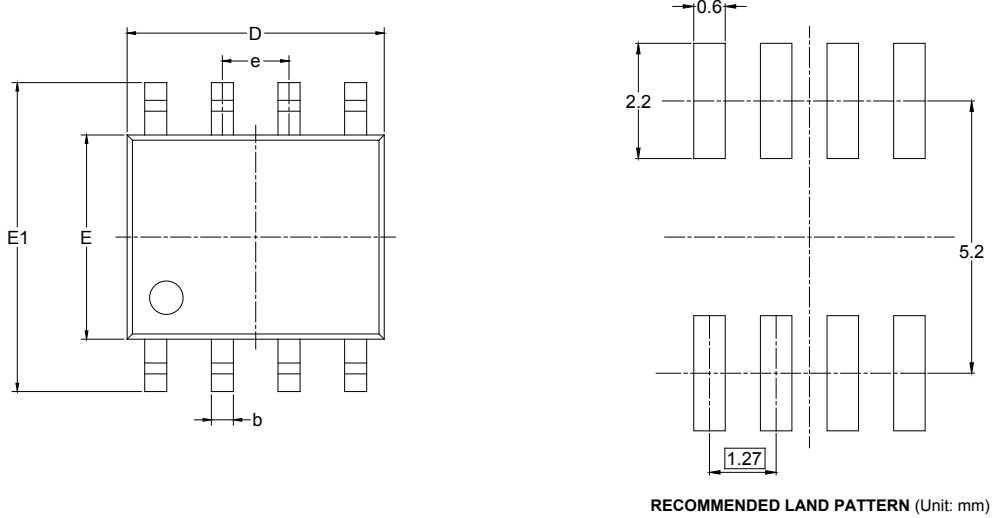

Symbol	Dimensions In Millimeters		Dimensions In Inches	
	MIN	MAX	MIN	MAX
A	1.350	1.750	0.053	0.069
A1	0.100	0.250	0.004	0.010
A2	1.350	1.550	0.053	0.061
b	0.330	0.510	0.013	0.020
c	0.170	0.250	0.006	0.010
D	4.700	5.100	0.185	0.200
E	3.800	4.000	0.150	0.157
E1	5.800	6.200	0.228	0.244
e	1.27 BSC		0.050 BSC	
L	0.400	1.270	0.016	0.050
$\theta$	0°	8°	0°	8°

# PACKAGE INFORMATION

## TAPE AND REEL INFORMATION

### REEL DIMENSIONS



### TAPE DIMENSIONS

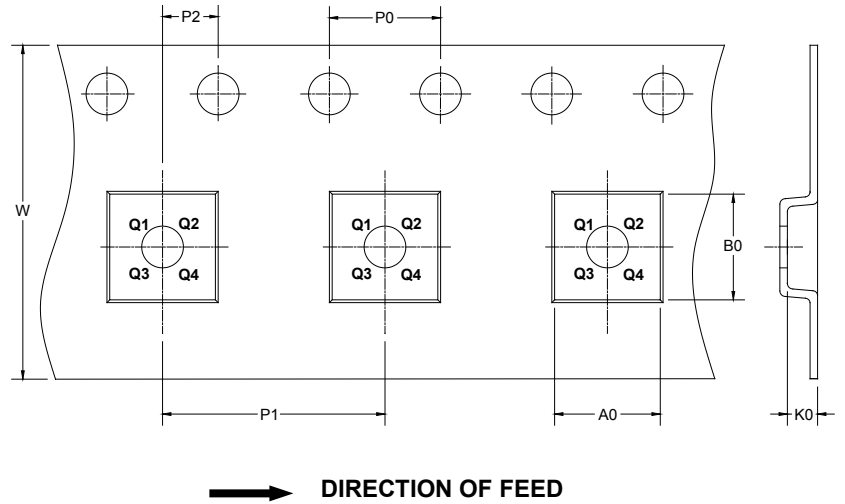

NOTE: The picture is only for reference. Please make the object as the standard.

### KEY PARAMETER LIST OF TAPE AND REEL

Package Type	Reel Diameter	Reel Width W1 (mm)	A0 (mm)	B0 (mm)	K0 (mm)	P0 (mm)	P1 (mm)	P2 (mm)	W (mm)	Pin1 Quadrant
SOT-23-5	7"	9.5	3.20	3.20	1.40	4.0	4.0	2.0	8.0	Q3
SC70-5	7"	9.5	2.25	2.55	1.20	4.0	4.0	2.0	8.0	Q3
TDFN-2×2-8L	7"	9.5	2.30	2.30	1.10	4.0	4.0	2.0	8.0	Q1
SOIC-8	13"	12.4	6.40	5.40	2.10	4.0	8.0	2.0	12.0	Q1

DD0001

# PACKAGE INFORMATION

## CARTON BOX DIMENSIONS



NOTE: The picture is only for reference. Please make the object as the standard.

## KEY PARAMETER LIST OF CARTON BOX

Reel Type	Length (mm)	Width (mm)	Height (mm)	Pizza/Carton
7" (Option)	368	227	224	8
7"	442	410	224	18
13"	386	280	370	5

DD0002