

SGM803B/SGM809B/SGM810B

Low Power Microprocessor Supervisory Circuit in 3-Pin SOT-23

GENERAL DESCRIPTION

The SGM803B/SGM809B/SGM810B supervisory circuits monitor the power supply voltage in microprocessor and digital systems. They provide a reset output during power-up, power-down and brownout conditions. On power-up, an internal timer holds reset asserted for 240ms. This holds the microprocessor in a reset state until conditions have stabilized. The nRESET output remains operational with V_{CC} as low as 1V. The SGM803B and SGM809B provide an active low reset signal (nRESET) while the SGM810B provides an active high signal (RESET) output. The SGM809B/SGM810B have push-pull outputs, whereas the SGM803B has an open-drain output, which requires an external pull-up resistor.

Five reset threshold voltage options are available, suitable for monitoring 3V, 3.3V and 5V supply voltages.

The reset comparator features built-in glitch immunity, making it immune to fast transients on V_{CC} .

The low supply current of typically 300nA makes the SGM803B/SGM809B/SGM810B ideal for use in portable, battery operated equipment. All are specified over the extended -40°C to +125°C temperature range.

FEATURES

- Precision Voltage Monitor: 3V, 3.3V and 5V Options
- Superior Upgrade for MAX803/MAX809/MAX810 and ADM803/ADM809/ADM810
- Fully Specified over Temperature
- VCC Transient Immunity
- Low Power Consumption: 300nA (TYP)
- Reset Assertion Down to 1V V_{CC}
- 150ms Power-On Reset (MIN)
 - Open-Drain nRESET Output (SGM803B)
 - Push-Pull nRESET Output (SGM809B)
 - Push-Pull RESET Output (SGM810B)
- -40°C to +125°C Operating Temperature Range
- Small Packaging
 - SGM803B Available in SOT-23-3 and SOT-23
 - SGM809B Available in SOT-23-3 and SOT-23
 - SGM810B Available in SOT-23-3 and SOT-23

APPLICATIONS

Microprocessor Systems
Controllers
Intelligent Instruments
Automotive Systems
Safety Systems
Portable Instruments

TYPICAL APPLICATION

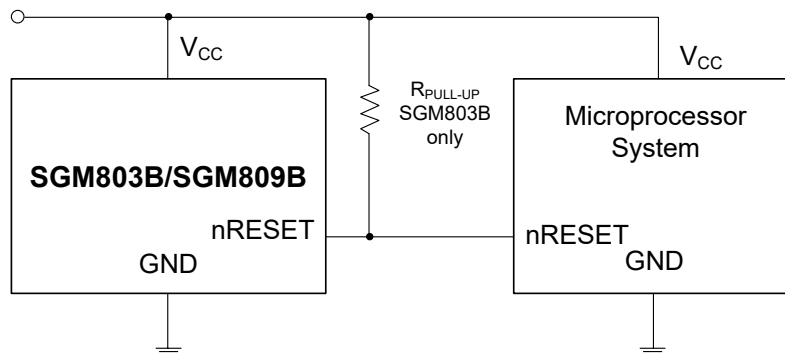

ABSOLUTE MAXIMUM RATINGS

V_{CC}	-0.3V to 6V
RESET, nRESET.....	-0.3V to $V_{CC} + 0.3V$
Input Current, V_{CC}	20mA
Output Current, RESET, nRESET.....	20mA
Rate of Rise, V_{CC}	100V/ μ s
Power Dissipation, $P_D @ T_A = +25^\circ C$	
SOT-23-3.....	0.4W
Package Thermal Resistance	
SOT-23-3, θ_{JA}	250°C/W
Junction Temperature.....	+150°C
Storage Temperature Range.....	-65°C to +150°C
Lead Temperature (Soldering, 10s).....	+260°C
ESD Susceptibility	
HBM.....	4000V
MM.....	400V
CDM.....	1000V

RECOMMENDED OPERATING CONDITIONS

Operating Temperature Range.....	-40°C to +125°C
----------------------------------	-----------------

OVERSTRESS CAUTION

Stresses beyond those listed in Absolute Maximum Ratings may cause permanent damage to the device. Exposure to absolute maximum rating conditions for extended periods may affect reliability. Functional operation of the device at any conditions beyond those indicated in the Recommended Operating Conditions section is not implied.

ESD SENSITIVITY CAUTION

This integrated circuit can be damaged by ESD if you don't pay attention to ESD protection. SGMICRO recommends that all integrated circuits be handled with appropriate precautions. Failure to observe proper handling and installation procedures can cause damage. ESD damage can range from subtle performance degradation to complete device failure. Precision integrated circuits may be more susceptible to damage because very small parametric changes could cause the device not to meet its published specifications.

DISCLAIMER

SG Micro Corp reserves the right to make any change in circuit design, or specifications without prior notice.

PIN CONFIGURATIONS

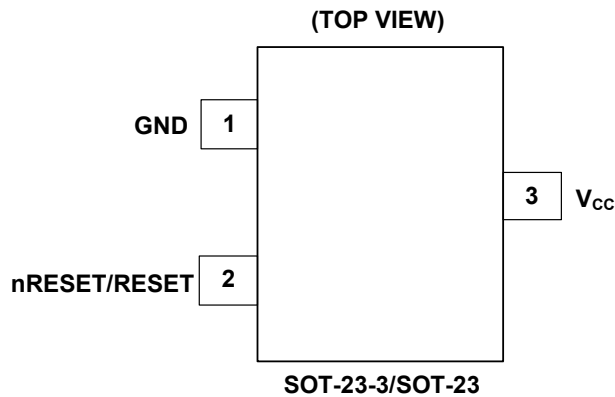

PIN DESCRIPTION

NAME	PIN NUMBER			FUNCTION
	SGM803B	SGM809B	SGM810B	
GND	1	1	1	Ground.
nRESET	2	2	—	Active Low Reset (SGM803B/SGM809B). nRESET remains low while V _{CC} is below the reset threshold, and remains low for 240ms (TYP) after V _{CC} rises above the reset threshold.
RESET	—	—	2	Active High Reset (SGM810B). RESET remains high while V _{CC} is below the reset threshold, and remains high for 240ms (TYP) after V _{CC} rises above the reset threshold.
V _{CC}	3	3	3	Power Supply. Power supply voltage that is monitored.

ELECTRICAL CHARACTERISTICS

(V_{CC} = 5V for M/J Models, 3.3V for T/S Models, 3V for R Model, unless otherwise noted.)

PARAMETER	CONDITIONS	MIN	TYP	MAX	UNITS
SUPPLY					
Voltage	T _A = +25°C	1		5.5	V
	T _A = -40°C to +125°C	1.25		5.5	
Current	V _{CC} < 5.5V, SGM8_M/J, T _A = +25°C		420	560	nA
	V _{CC} < 5.5V, SGM8_M/J, T _A = -40°C to +125°C			730	
	V _{CC} < 3.6V, SGM8_R/S/T, T _A = +25°C		300	430	nA
	V _{CC} < 3.6V, SGM8_R/S/T, T _A = -40°C to +125°C			590	
RESET VOLTAGE THRESHOLD					
SGM8_M	V _{CC} falling, T _A = +25°C	4.247	4.38	4.452	V
	V _{CC} falling, T _A = -40°C to +125°C	4.217		4.482	
SGM8_J	V _{CC} falling, T _A = +25°C	3.883	4.00	4.072	V
	V _{CC} falling, T _A = -40°C to +125°C	3.859		4.101	
SGM8_T	V _{CC} falling, T _A = +25°C	3.001	3.08	3.151	V
	V _{CC} falling, T _A = -40°C to +125°C	2.966		3.181	
SGM8_S	V _{CC} falling, T _A = +25°C	2.860	2.93	2.998	V
	V _{CC} falling, T _A = -40°C to +125°C	2.841		3.018	
SGM8_R	V _{CC} falling, T _A = +25°C	2.571	2.63	2.698	V
	V _{CC} falling, T _A = -40°C to +125°C	2.525		2.745	
Hysteresis Voltage Ratio	V _{CC} rising		0.5%		
Reset Threshold Temperature Coefficient			35		ppm/°C
V _{CC} to RESET/nRESET Delay	V _{CC} falling from (V _{TH} + V _{HYS}) × (1 + 5%) to V _{TH} × (1 - 5%) ⁽¹⁾		110		μs
Reset Active Timeout Period	T _A = +25°C	150	240	370	ms
	T _A = -40°C to +125°C	110		400	
RESET/nRESET OUTPUT VOLTAGE					
Low (SGM803B-R/S/T) Low (SGM809B-R/S/T)	V _{CC} = V _{TH(MIN)} , I _{SINK} = 1.2mA			0.3	V
Low (SGM803B-M/J) Low (SGM809B-M/J)	V _{CC} = V _{TH(MIN)} , I _{SINK} = 3.2mA			0.4	V
Low (SGM803B-R/S/T/M/J) Low (SGM809B-R/S/T/M/J)	V _{CC} > 1V, I _{SINK} = 50μA			0.3	V
High (SGM809B-R/S/T)	V _{CC} > V _{TH(MAX)} , I _{SOURCE} = 500μA	0.8 × V _{CC}			V
High (SGM809B-M/J)	V _{CC} > V _{TH(MAX)} , I _{SOURCE} = 800μA	V _{CC} - 1.5			V
Low (SGM810B-R/S/T)	V _{CC} = V _{TH(MAX)} , I _{SINK} = 1.2mA			0.3	V
Low (SGM810B-M/J)	V _{CC} = V _{TH(MAX)} , I _{SINK} = 3.2mA			0.4	V
High (SGM810B-R/S/T/M/J)	1.8V < V _{CC} < V _{TH(MIN)} , I _{SOURCE} = 150μA	0.8 × V _{CC}			V
nRESET Open-Drain Output Leakage Current (SGM803B)	V _{CC} > V _{TH} , reset de-asserted			1	μA

NOTE:

1. V_{TH} stands for reset voltage threshold and V_{HYS} stands for hysteresis voltage.

TYPICAL PERFORMANCE CHARACTERISTICS

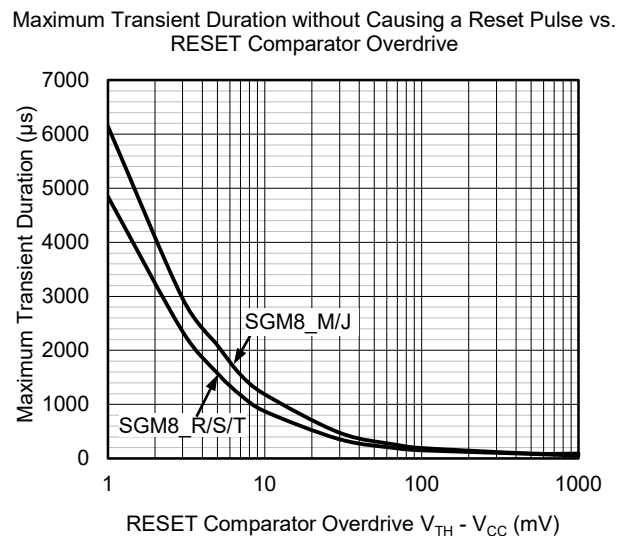
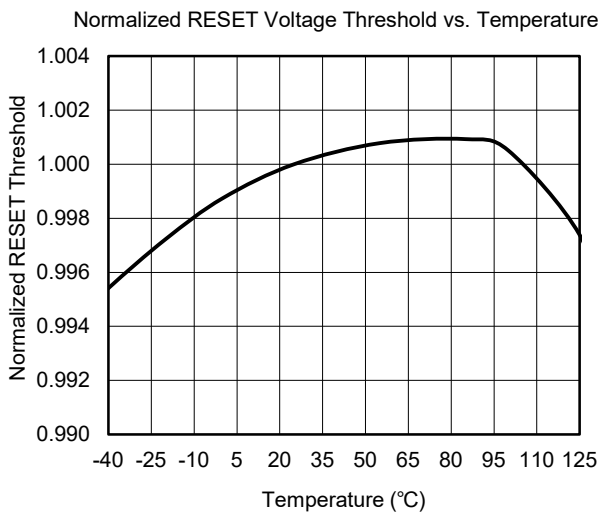
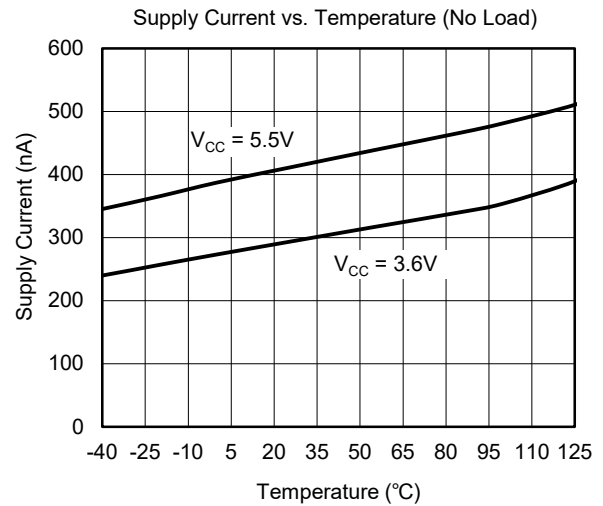
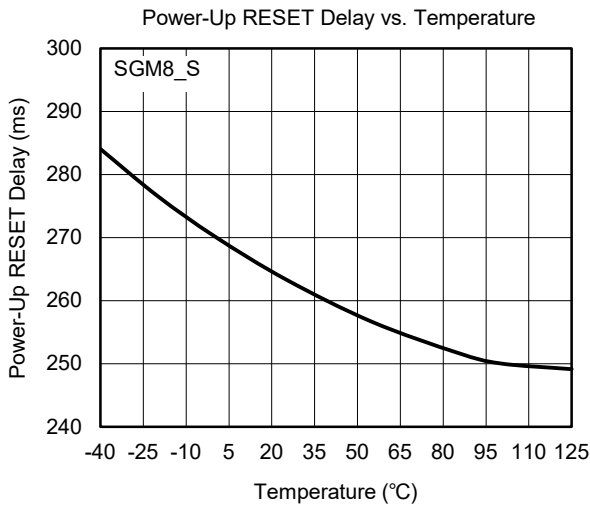
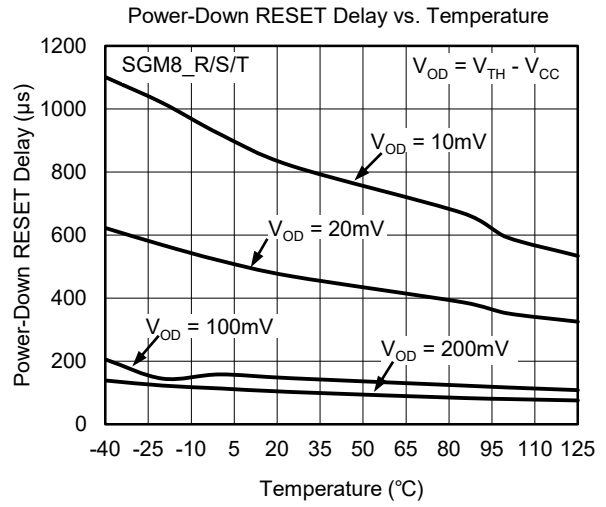
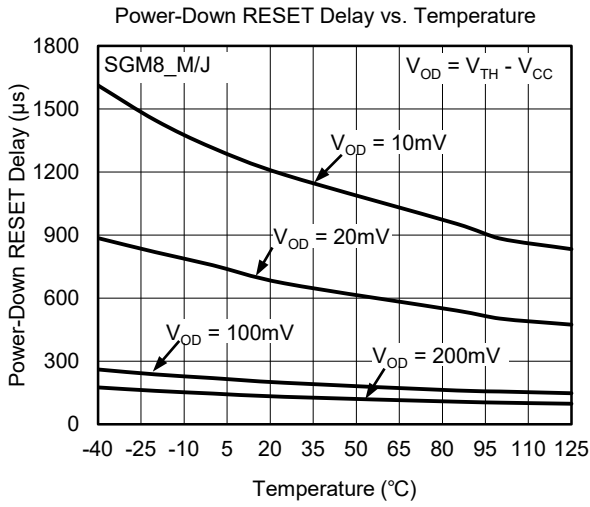

TYPICAL PERFORMANCE CHARACTERISTICS (continued)

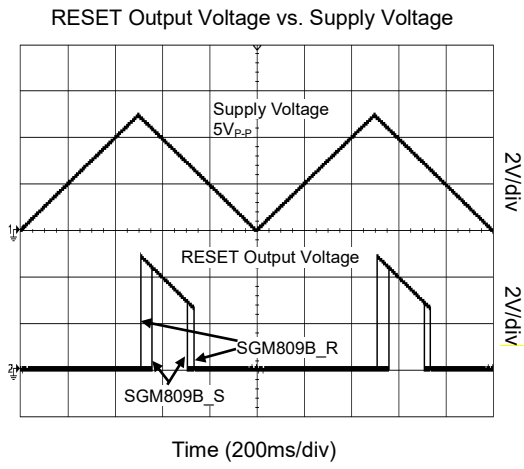

APPLICATION INFORMATION

Benefits of an Accurate Reset Threshold

In other microprocessor supervisory circuits, tolerances in supply voltages lead to an overall increase in reset tolerance levels due to the deterioration of the microprocessor reset circuit's power supply. The possibility of a malfunction during a power failure is greatly reduced because the SGM803B/SGM809B/SGM810B series can operate effectively even when there are large degradations of the supply voltages. Another advantage of the SGM803B/SGM809B/SGM810B series is its very accurate internal voltage reference circuit. These benefits combine to produce an exceptionally reliable voltage monitor circuit.

Interfacing to Microprocessors with Multiple Interrupts

In a number of cases, it is necessary to interface many interrupts from different devices (for example, thermal, altitude, and velocity sensors). The SGM803B/SGM809B/SGM810B can easily be integrated into existing interrupt-handling circuits, as shown in Figure 1, or can be used as a standalone device.

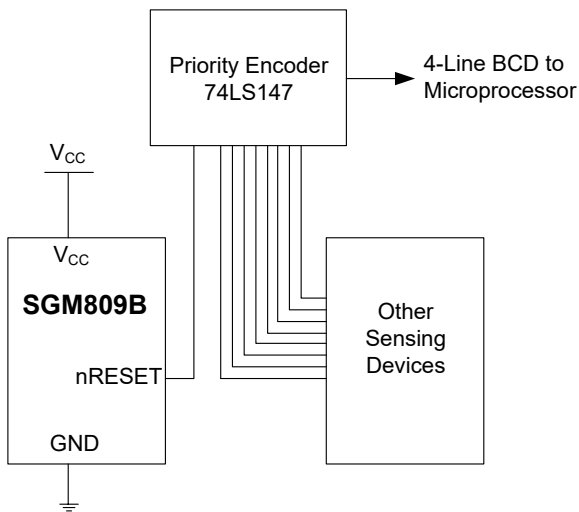

Figure 1. Interfacing to Microprocessors with Multiple Interrupts

Interfacing to Other Devices' Output

The SGM803B/SGM809B/SGM810B series is designed to integrate with as many devices as possible, therefore, has a standard output dependent on V_{CC}. This enables the parts to be used in both 3V and 5V, or any nominal voltage within the minimum and maximum specifications for V_{CC}. This design simplifies interfacing this device to other devices.

Ensuring a Valid Reset Output Down to V_{CC} = 0V

When V_{CC} falls below 1V, the SGM803B/SGM809B nRESET no longer sinks current. A high impedance CMOS logic input connected to nRESET may, therefore, drift to undetermined logic levels. To eliminate this problem, a 100kΩ resistor should be connected from nRESET to ground.

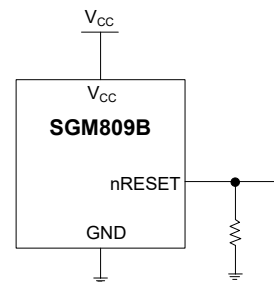

Figure 2. Ensuring a Valid Reset Output Down to V_{CC} = 0V

Preventing the High Voltage Spike

To prevent the high voltage spike damage or to limit input V_{CC} current, it is recommended to connect a resistor R1 (0Ω to 1kΩ) in series to V_{CC}, and one capacitor C1 (0.1μF to 4.7μF) should be connected between V_{CC} pin and GND. The schematic is shown in Figure 3. It must be noted that, the input resistor will affect output driving capability.

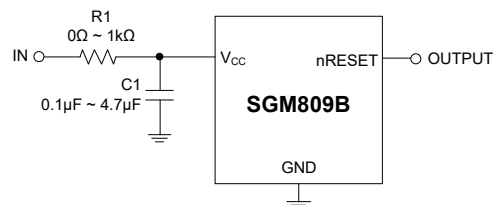
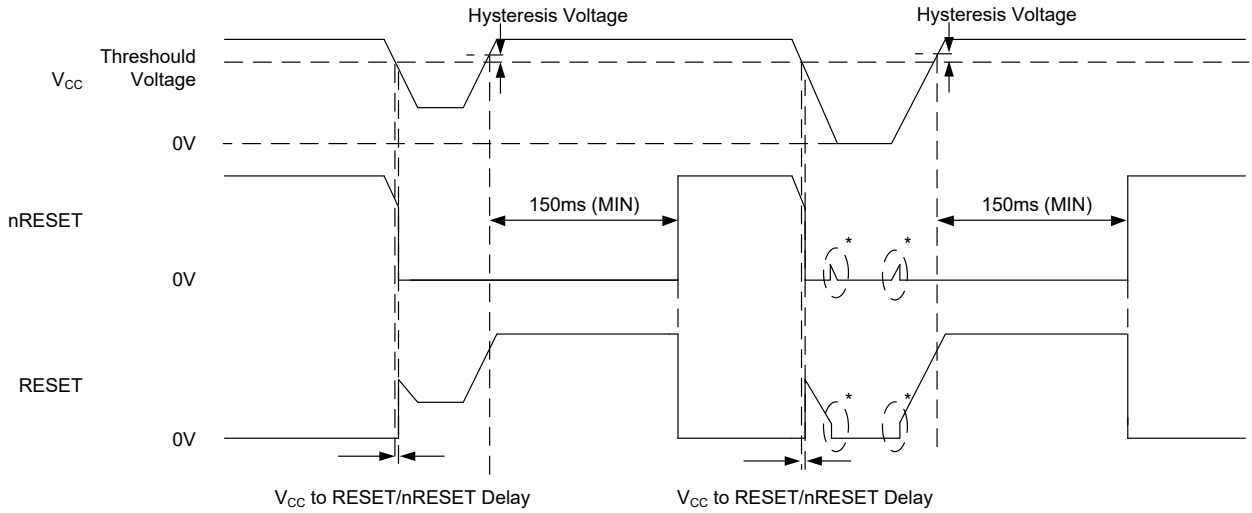

Figure 3. Preventing the High Voltage Spike

DETAILED DESCRIPTIONS

Reset Timing

The reset signal is asserted low for the SGM809B and high for the SGM810B when the power supply voltage falls below the threshold trip voltage and remains asserted for at least 150ms after the power supply voltage has risen above the threshold.



NOTE *: Undefined below minimum operating voltage.

Figure 4. Reset Timing Diagram

REVISION HISTORY

NOTE: Page numbers for previous revisions may differ from page numbers in the current version.

Changes from Original (AUGUST 2018) to REV.A

Changed from product preview to production data.....	All
--	-----

PACKAGE OUTLINE DIMENSIONS

SOT-23

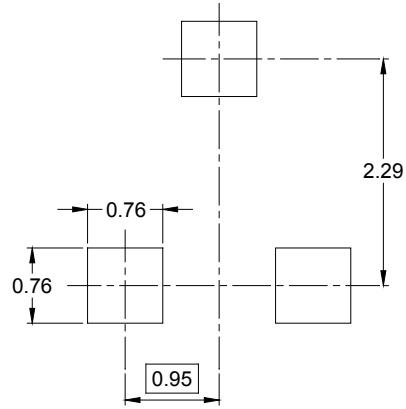
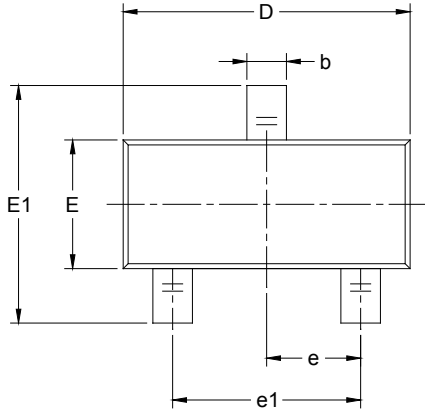

RECOMMENDED LAND PATTERN (Unit: mm)

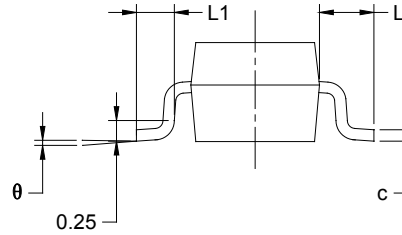
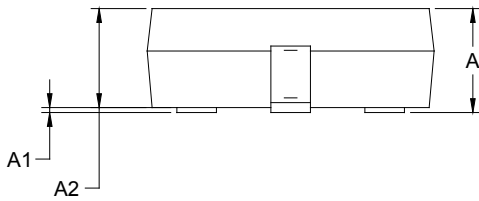

Symbol	Dimensions In Millimeters		Dimensions In Inches	
	MIN	MAX	MIN	MAX
A	0.900	1.150	0.035	0.045
A1	0.000	0.100	0.000	0.004
A2	0.900	1.050	0.035	0.041
b	0.300	0.500	0.012	0.020
c	0.080	0.150	0.003	0.006
D	2.800	3.000	0.110	0.118
E	1.200	1.400	0.047	0.055
E1	2.250	2.550	0.089	0.100
e	0.950 BSC		0.037 BSC	
e1	1.900 BSC		0.075 BSC	
L	0.550 REF		0.022 REF	
L1	0.300	0.500	0.012	0.020
θ	0°	8°	0°	8°

PACKAGE INFORMATION

PACKAGE OUTLINE DIMENSIONS

SOT-23-3

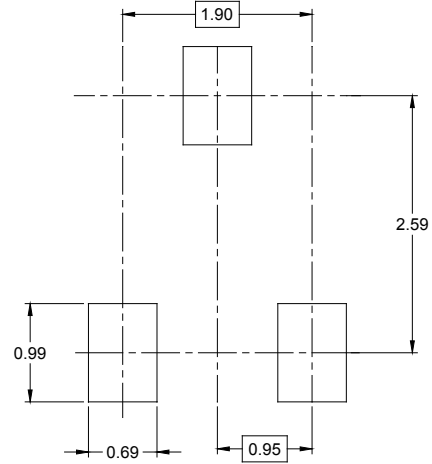
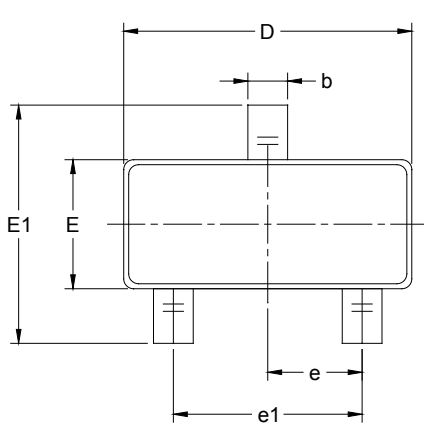

RECOMMENDED LAND PATTERN (Unit: mm)

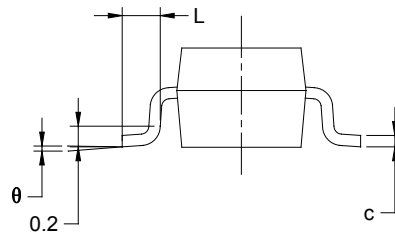
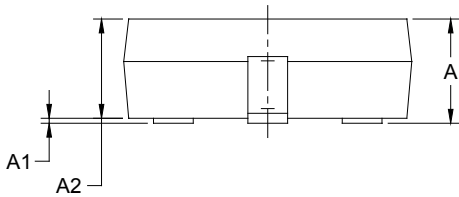

Symbol	Dimensions In Millimeters		Dimensions In Inches	
	MIN	MAX	MIN	MAX
A	1.050	1.250	0.041	0.049
A1	0.000	0.100	0.000	0.004
A2	1.050	1.150	0.041	0.045
b	0.300	0.500	0.012	0.020
c	0.100	0.200	0.004	0.008
D	2.820	3.020	0.111	0.119
E	1.500	1.700	0.059	0.067
E1	2.650	2.950	0.104	0.116
e	0.950 BSC		0.037 BSC	
e1	1.900 BSC		0.075 BSC	
L	0.300	0.600	0.012	0.024
θ	0°	8°	0°	8°

TAPE AND REEL INFORMATION

REEL DIMENSIONS



TAPE DIMENSIONS

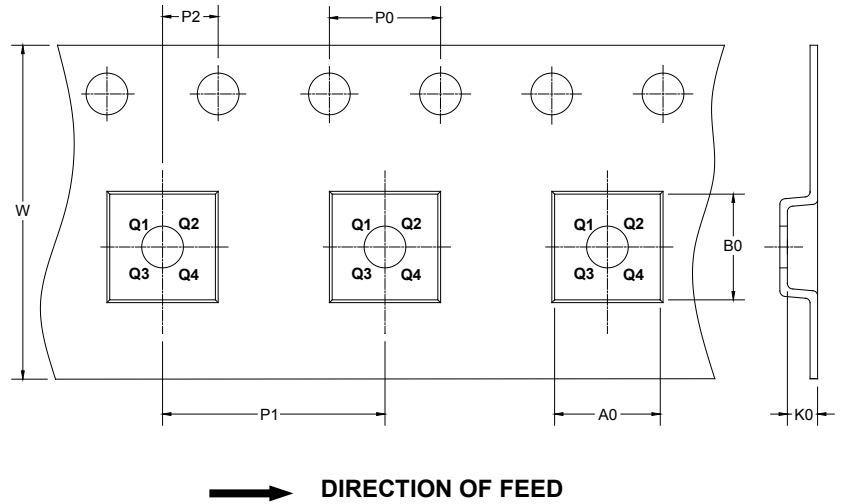

NOTE: The picture is only for reference. Please make the object as the standard.

KEY PARAMETER LIST OF TAPE AND REEL

Package Type	Reel Diameter	Reel Width W1 (mm)	A0 (mm)	B0 (mm)	K0 (mm)	P0 (mm)	P1 (mm)	P2 (mm)	W (mm)	Pin1 Quadrant
SOT-23-3	7"	9.0	3.20	3.30	1.30	4.0	4.0	2.0	8.0	Q3
SOT-23	7"	9.5	3.15	2.77	1.22	4.0	4.0	2.0	8.0	Q3

000001

PACKAGE INFORMATION

CARTON BOX DIMENSIONS



NOTE: The picture is only for reference. Please make the object as the standard.

KEY PARAMETER LIST OF CARTON BOX

Reel Type	Length (mm)	Width (mm)	Height (mm)	Pizza/Carton
7" (Option)	368	227	224	8
7"	442	410	224	18

DD0002