

GENERAL DESCRIPTION

The SGM2203 series is a set of low power high voltage regulators implemented in CMOS technology which can provide 150mA output current. The device allows input voltage as high as 36V. The SGM2203 series is available in several fixed output voltages. CMOS technology ensures low dropout voltage and low quiescent current.

Although designed primarily as fixed voltage regulators, the device can be used with external components to obtain variable output voltages.

The SGM2203 series is available in Green SOT-23, SOT-23-5 and SOT-89-3 packages. It operates over an ambient temperature range of -40°C to +85°C.

FEATURES

- **Low Power Consumption**
- **150mA Nominal Output Current**
- **Low Dropout Voltage**
- **Low Temperature Coefficient**
- **High Input Voltage (up to 36V)**
- **Output Voltage Accuracy: ±3%**
- **Fixed Output Voltage Versions:
0.8V to 4.7V with 0.1V per Step
5V to 12V with 0.25V per Step**
- **-40°C to +85°C Operating Temperature Range**
- **Available in Green SOT-23, SOT-23-5 and SOT-89-3 Packages**

APPLICATIONS

Battery-Powered Equipment
 Communication Equipment
 Audio/Video Equipment

TYPICAL APPLICATION

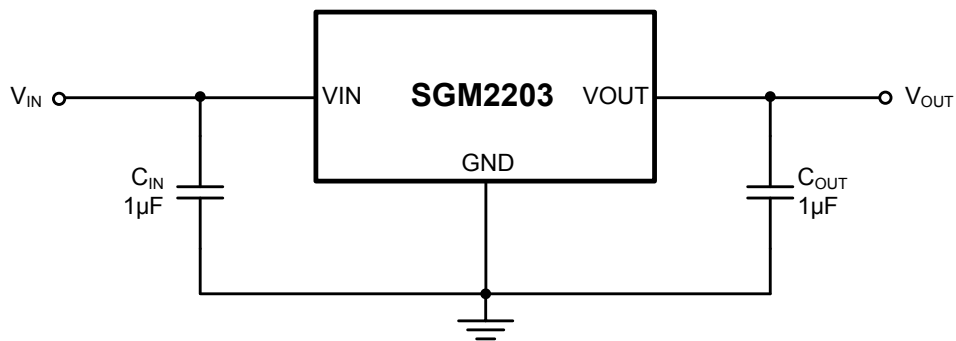

Figure 1. Typical Application Circuit

PACKAGE/ORDERING INFORMATION

MODEL	V _{OUT} (V)	PACKAGE DESCRIPTION	ORDERING NUMBER	PACKAGE MARKING	PACKING OPTION
SGM2203-0.9	0.9	SOT-23	SGM2203-0.9YN3LG/TR	SW0XX	Tape and Reel, 3000
SGM2203-1.0	1.0	SOT-23	SGM2203-1.0YN3LG/TR	SW1XX	Tape and Reel, 3000
SGM2203-1.1	1.1	SOT-23	SGM2203-1.1YN3LG/TR	SW2XX	Tape and Reel, 3000
SGM2203-1.2	1.2	SOT-23	SGM2203-1.2YN3LG/TR	SW3XX	Tape and Reel, 3000
SGM2203-1.5	1.5	SOT-23	SGM2203-1.5YN3LG/TR	SW4XX	Tape and Reel, 3000
SGM2203-1.8	1.8	SOT-23	SGM2203-1.8YN3LG/TR	SW5XX	Tape and Reel, 3000
SGM2203-2.5	2.5	SOT-23	SGM2203-2.5YN3LG/TR	SW6XX	Tape and Reel, 3000
SGM2203-2.8	2.8	SOT-23	SGM2203-2.8YN3LG/TR	SW7XX	Tape and Reel, 3000
SGM2203-3.0	3.0	SOT-23	SGM2203-3.0YN3LG/TR	SW8XX	Tape and Reel, 3000
SGM2203-3.3	3.3	SOT-23	SGM2203-3.3YN3LG/TR	SW9XX	Tape and Reel, 3000
SGM2203-3.6	3.6	SOT-23	SGM2203-3.6YN3LG/TR	SWAXX	Tape and Reel, 3000
SGM2203-5.0	5.0	SOT-23	SGM2203-5.0YN3LG/TR	SWBXX	Tape and Reel, 3000
SGM2203-2.5	2.5	SOT-89-3	SGM2203-2.5YK3G/TR	SWCXX	Tape and Reel, 1000
SGM2203-3.3	3.3	SOT-89-3	SGM2203-3.3YK3G/TR	SWDXX	Tape and Reel, 1000
SGM2203-3.6	3.6	SOT-89-3	SGM2203-3.6YK3G/TR	SWFXX	Tape and Reel, 1000
SGM2203-5.0	5.0	SOT-89-3	SGM2203-5.0YK3G/TR	SWEXX	Tape and Reel, 1000
SGM2203-8.0	8.0	SOT-89-3	SGM2203-8.0YK3G/TR	G74XX	Tape and Reel, 1000
SGM2203-12	12	SOT-89-3	SGM2203-12YK3G/TR	G3FXX	Tape and Reel, 1000
SGM2203-3.0	3.0	SOT-89-3 (L-Type)	SGM2203-3.0YK3LG/TR	SX0XX	Tape and Reel, 1000
SGM2203-3.3	3.3	SOT-89-3 (L-Type)	SGM2203-3.3YK3LG/TR	G75XX	Tape and Reel, 1000
SGM2203-3.5	3.5	SOT-89-3 (L-Type)	SGM2203-3.5YK3LG/TR	G7EXX	Tape and Reel, 1000
SGM2203-3.7	3.7	SOT-89-3 (L-Type)	SGM2203-3.7YK3LG/TR	GB4XX	Tape and Reel, 1000
SGM2203-4.0	4.0	SOT-89-3 (L-Type)	SGM2203-4.0YK3LG/TR	GF3XX	Tape and Reel, 1000
SGM2203-4.1	4.1	SOT-89-3 (L-Type)	SGM2203-4.1YK3LG/TR	GF4XX	Tape and Reel, 1000
SGM2203-5.0	5.0	SOT-89-3 (L-Type)	SGM2203-5.0YK3LG/TR	SX1XX	Tape and Reel, 1000
SGM2203-8.0	8.0	SOT-89-3 (L-Type)	SGM2203-8.0YK3LG/TR	SX2XX	Tape and Reel, 1000
SGM2203-9.0	9.0	SOT-89-3 (L-Type)	SGM2203-9.0YK3LG/TR	SX3XX	Tape and Reel, 1000
SGM2203-12	12	SOT-89-3 (L-Type)	SGM2203-12YK3LG/TR	G40XX	Tape and Reel, 1000
SGM2203-3.0	3.0	SOT-23-5	SGM2203-3.0YN5G/TR	GDFXX	Tape and Reel, 3000
SGM2203-3.3	3.3	SOT-23-5	SGM2203-3.3YN5G/TR	GE0XX	Tape and Reel, 3000
SGM2203-5.0	5.0	SOT-23-5	SGM2203-5.0YN5G/TR	GJ9XX	Tape and Reel, 3000
SGM2203-4.2	4.2	SOT-23-5 (L-Type)	SGM2203-4.2YN5LG/TR	GN9XX	Tape and Reel, 3000

NOTE: The devices are available in fixed output voltages from 0.8V to 4.7V with 0.1V per step, and from 5V to 12V with 0.25V per step.

Green (RoHS & HSF): SG Micro Corp defines "Green" to mean Pb-Free (RoHS compatible) and free of halogen substances. If you have additional comments or questions, please contact your SGMICRO representative directly.

ABSOLUTE MAXIMUM RATINGS

VIN to GND.....	-0.3V to 44V
VOUT to GND, VOUT ≤ 5.0V	-0.3V to Min(VIN + 0.3V, 6V)
VOUT to GND, VOUT > 5.0V	-0.3V to Min(VIN + 0.3V, 15V)
Power Dissipation, PD @ TA = +25°C	
SOT-23	0.411W
SOT-23-5	0.411W
SOT-23-5 (L-Type).....	0.517W
SOT-89-3	1.923W
SOT-89-3 (L-Type).....	0.822W
Package Thermal Resistance	
SOT-23, θJA.....	304°C/W
SOT-23-5, θJA	304°C/W
SOT-23-5 (L-Type), θJA	242°C/W
SOT-89-3, θJA	65°C/W
SOT-89-3 (L-Type), θJA	152°C/W
Junction Temperature	+150°C
Storage Temperature Range.....	-65°C to +150°C
Lead Temperature (Soldering, 10s)	+260°C
ESD Susceptibility	
HBM.....	4000V
MM.....	200V
CDM	1000V

RECOMMENDED OPERATING CONDITIONS

Input Voltage Range	2.7V to 36V
Operating Temperature Range	-40°C to +85°C

MARKING INFORMATION

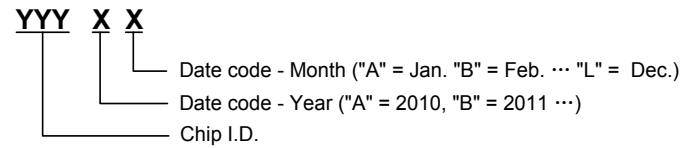

For example: SW0FA (2015, January)

OVERSTRESS CAUTION

Stresses beyond those listed may cause permanent damage to the device. Functional operation of the device at these or any other conditions beyond those indicated in the operational section of the specification is not implied. Exposure to absolute maximum rating conditions for extended periods may affect reliability.

ESD SENSITIVITY CAUTION

This integrated circuit can be damaged by ESD if you don't pay attention to ESD protection. SGMICRO recommends that all integrated circuits be handled with appropriate precautions. Failure to observe proper handling and installation procedures can cause damage. ESD damage can range from subtle performance degradation to complete device failure. Precision integrated circuits may be more susceptible to damage because very small parametric changes could cause the device not to meet its published specifications.

DISCLAIMER

SG Micro Corp reserves the right to make any change in circuit design, specification or other related things if necessary without notice at any time.

PIN CONFIGURATIONS

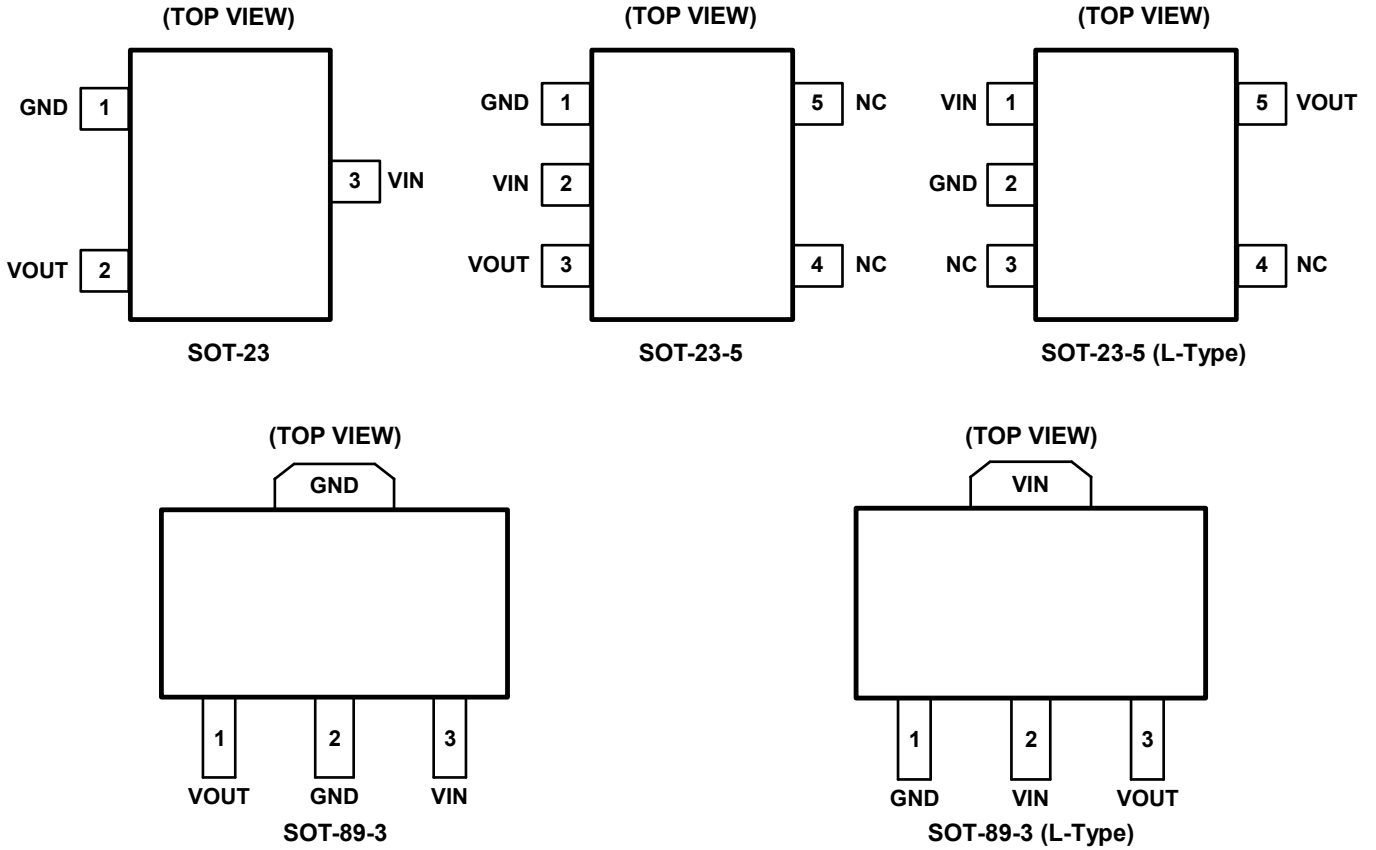

PIN DESCRIPTION

PIN					NAME	FUNCTION
SOT-23	SOT-23-5	SOT-23-5 (L-Type)	SOT-89-3	SOT-89-3 (L-Type)		
1	1	2	2	1	GND	Ground.
2	3	5	1	3	VOUT	Regulator Output. Recommended output capacitor range: 1µF to 10µF.
3	2	1	3	2	VIN	Regulator Input. Up to 36V input voltage. At least 1µF supply bypass capacitor is recommended.
-	4, 5	3, 4	-	-	NC	Not Connect.

ELECTRICAL CHARACTERISTICS

($V_{IN} = V_{OUT} + 2V$ or $4V$, whichever is greater, $C_{IN} = C_{OUT} = 1\mu F$, Full = $-40^{\circ}C$ to $+85^{\circ}C$, typical values are at $T_A = +25^{\circ}C$, unless otherwise noted.)

PARAMETER	SYMBOL	CONDITIONS	TEMP	MIN	TYP	MAX	UNITS
Input Voltage	V_{IN}	$V_{OUT} < 3.3V$	Full	2.7		32	V
		$V_{OUT} \geq 3.3V$	Full	2.7		36	
Output Voltage Accuracy		$I_{OUT} = 1mA$	$+25^{\circ}C$	-3		3	%
Ground Pin Current		No load	$+25^{\circ}C$		4.2	5.5	μA
			Full			6.5	
		$I_{OUT} = 50mA$	$+25^{\circ}C$		4.2		
Maximum Output Current ⁽¹⁾			$+25^{\circ}C$	150			mA
Dropout Voltage ⁽²⁾	V_{DROP}	$I_{OUT} = 150mA, V_{OUT} \geq 2.5V$	$+25^{\circ}C$		1300	1850	mV
			Full			2400	
Line Regulation	$\frac{\Delta V_{OUT}}{\Delta V_{IN} \times V_{OUT}}$	$V_{IN} = V_{OUT} + 2V$ or $4V$ to $32V, I_{OUT} = 1mA, V_{OUT} < 3.3V$	$+25^{\circ}C$		0.005	0.012	%V
		$V_{IN} = V_{OUT} + 2V$ to $36V, I_{OUT} = 1mA, V_{OUT} \geq 3.3V$	$+25^{\circ}C$		0.005	0.012	
Load Regulation	ΔV_{OUT}	$V_{IN} = V_{OUT} + 2V$ or $4V, I_{OUT} = 1mA$ to $150mA$	$+25^{\circ}C$		10	25	mV
Power Supply Rejection Ratio	PSRR	$V_{OUT} = 3.3V, I_{OUT} = 10mA$	$f = 217Hz$	$+25^{\circ}C$		55	dB
			$f = 1kHz$	$+25^{\circ}C$		40	
Output Voltage Temperature Coefficient ⁽³⁾	$\frac{\Delta V_{OUT}}{\Delta T_A \times V_{OUT}}$	$I_{OUT} = 1mA$	Full		68		ppm/ $^{\circ}C$
THERMAL PROTECTION							
Thermal Shutdown Temperature	T_{SHDN}				150		$^{\circ}C$
Thermal Shutdown Hysteresis	ΔT_{SHDN}				20		$^{\circ}C$

NOTES:

- Maximum output current is affected by the PCB layout, size of metal trace, the thermal conduction path between metal layers, ambient temperature and the other environment factors of system. Attention should be paid to the dropout voltage when $V_{IN} < V_{OUT} + V_{DROP}$.
- The dropout voltage is defined as $V_{IN} - V_{OUT}$, when V_{OUT} is 95% of the value of V_{OUT} for $V_{IN} = V_{OUT} + 2V$.
- Output voltage temperature coefficient is defined as the worst-case voltage change divided by the total temperature range.

TYPICAL PERFORMANCE CHARACTERISTICS

$V_{IN} = 5.3V$, $V_{OUT} = 3.3V$, $C_{IN} = C_{OUT} = 1\mu F$, $T_A = +25^\circ C$, unless otherwise noted.

Load-Transient Response

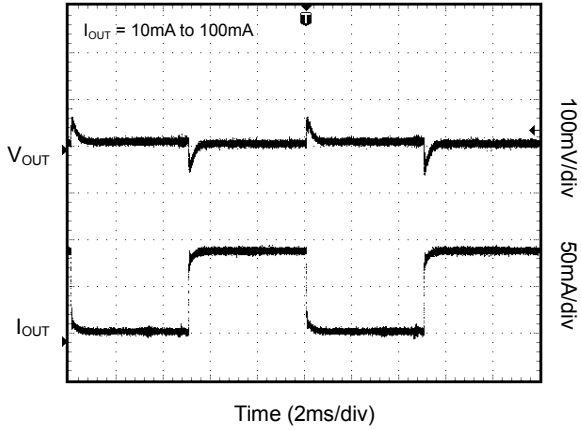

Line-Transient Response

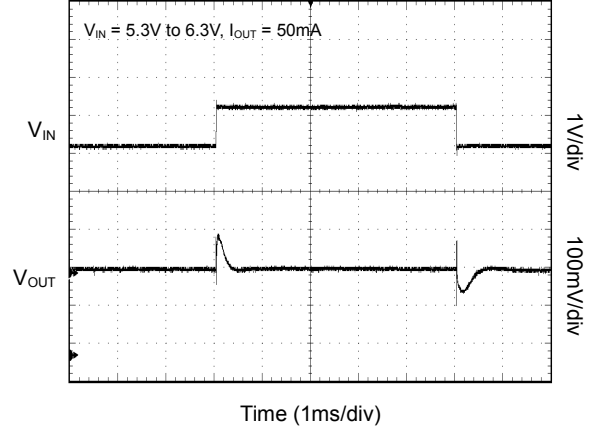

Power-Up/Power-Down Output Waveform

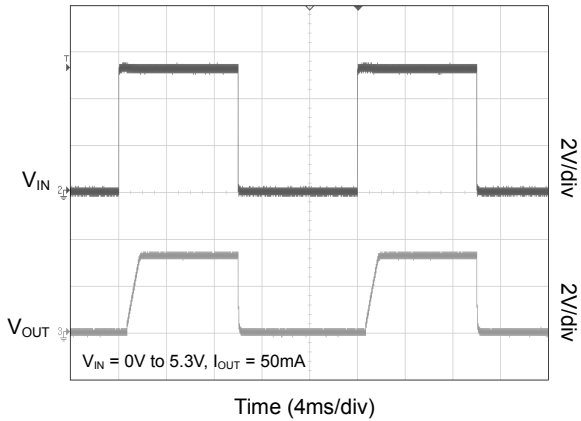

Power Ramp-Up/Ramp-Down Output Waveform

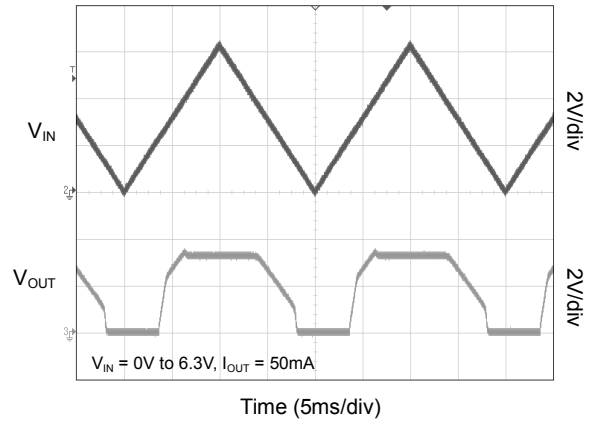

Output Short Waveform

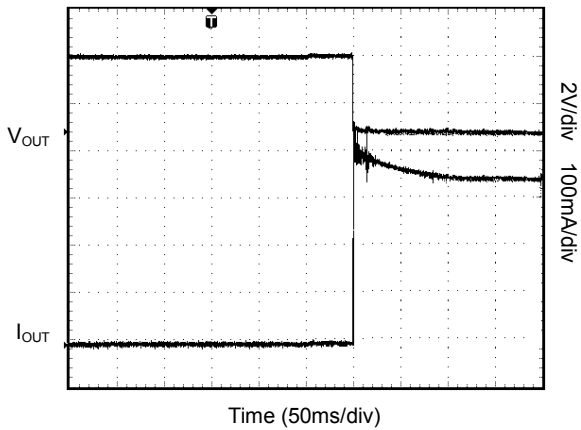

Thermal Protection Waveform

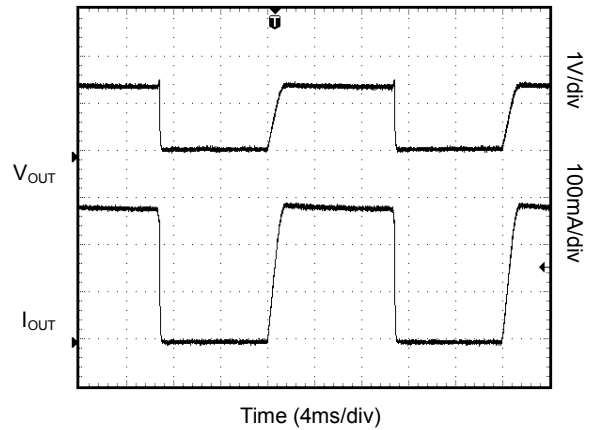

TYPICAL PERFORMANCE CHARACTERISTICS

$V_{IN} = 5.3V$, $V_{OUT} = 3.3V$, $C_{IN} = C_{OUT} = 1\mu F$, $T_A = +25^\circ C$, unless otherwise noted.

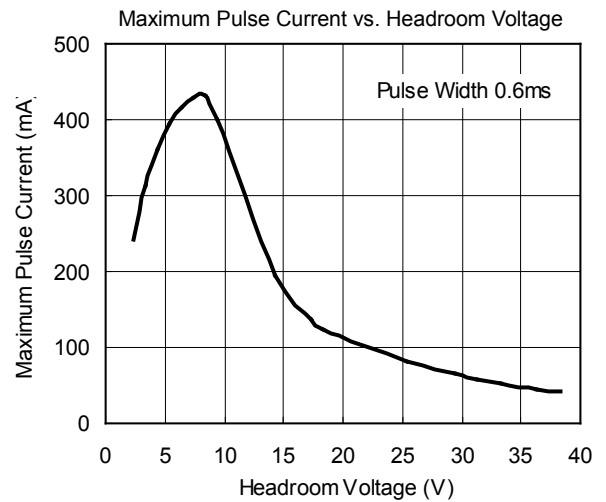
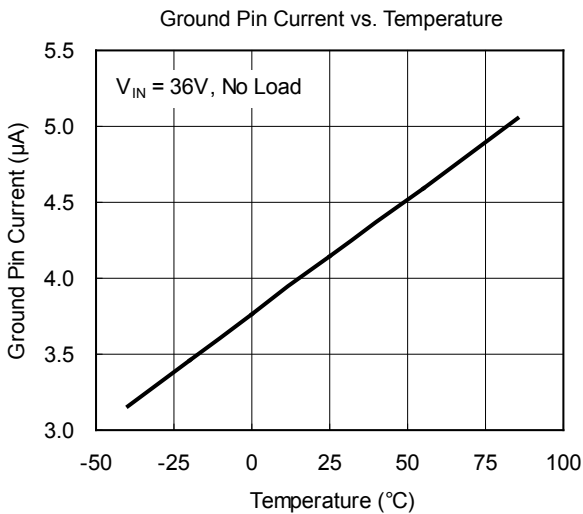
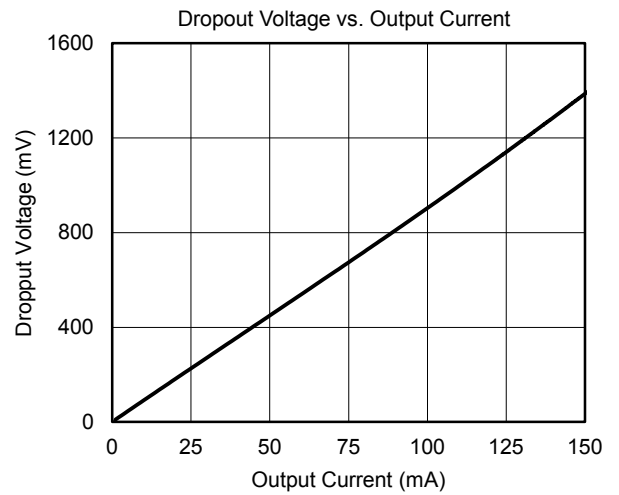
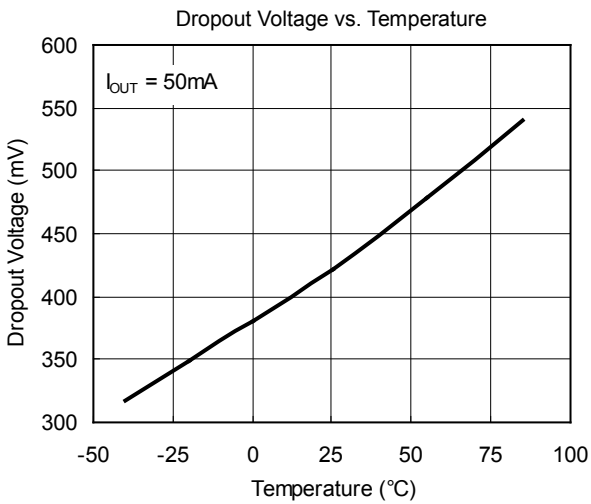
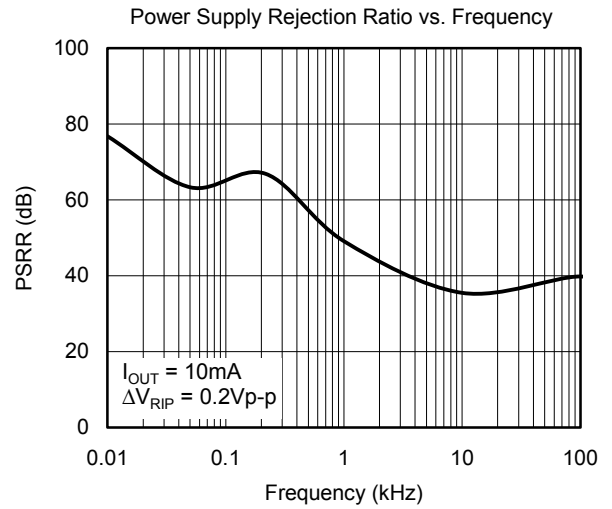
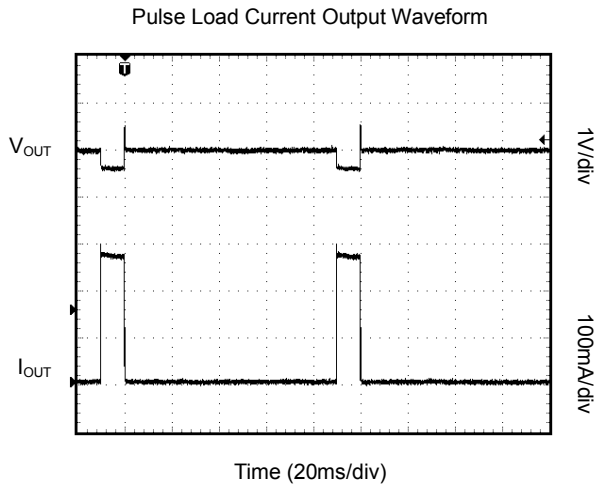

APPLICATION INFORMATION

Input Capacitor and Output Capacitor

For proper operation, place a ceramic capacitor (C_{IN}) between 1 μ F and 10 μ F between the input pin and ground. Larger values in this range will help improve line transient response.

For stable operation, use a ceramic capacitor (C_{OUT}) between 1 μ F and 10 μ F. Larger values in this range will help improve load transient response and reduce noise. Output capacitors of other dielectric types may be used, but are not recommended as their capacitance can deviate greatly from their rated value over temperature.

Thermal Considerations

When the junction temperature is too high, the thermal protection circuitry sends a signal to the control logic that will shutdown the IC. The IC will restart when the temperature has sufficiently cooled down.

The maximum power dissipation is dependent on the thermal resistance of the case and the circuit board, the temperature difference between the die junction and the ambient air, and the rate of air flow. The GND pin must be connected to the ground plane for proper dissipation.

REVISION HISTORY

NOTE: Page numbers for previous revisions may differ from page numbers in the current version.

AUGUST 2017 – REV.A to REV.A.1

Added SOT-23-5 package2-4

Changes from Original (JUNE 2017) to REV.A

Changed from product preview to production data..... All

PACKAGE OUTLINE DIMENSIONS

SOT-23

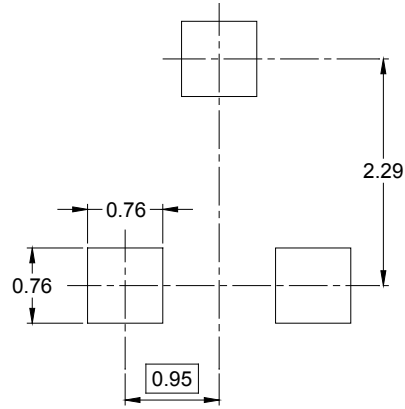
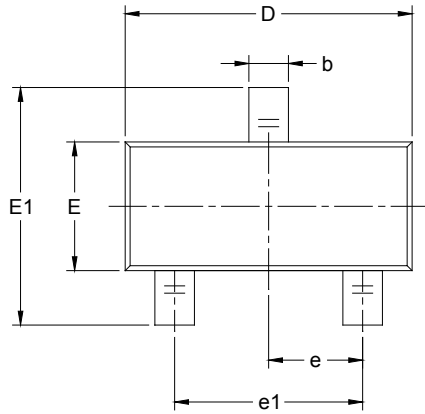

RECOMMENDED LAND PATTERN (Unit: mm)

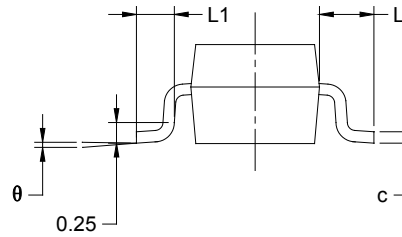
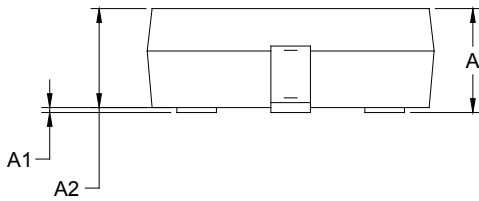

Symbol	Dimensions In Millimeters		Dimensions In Inches	
	MIN	MAX	MIN	MAX
A	0.900	1.150	0.035	0.045
A1	0.000	0.100	0.000	0.004
A2	0.900	1.050	0.035	0.041
b	0.300	0.500	0.012	0.020
c	0.080	0.150	0.003	0.006
D	2.800	3.000	0.110	0.118
E	1.200	1.400	0.047	0.055
E1	2.250	2.550	0.089	0.100
e	0.950 BSC		0.037 BSC	
e1	1.900 BSC		0.075 BSC	
L	0.550 REF		0.022 REF	
L1	0.300	0.500	0.012	0.020
θ	0°	8°	0°	8°

PACKAGE OUTLINE DIMENSIONS

SOT-23-5

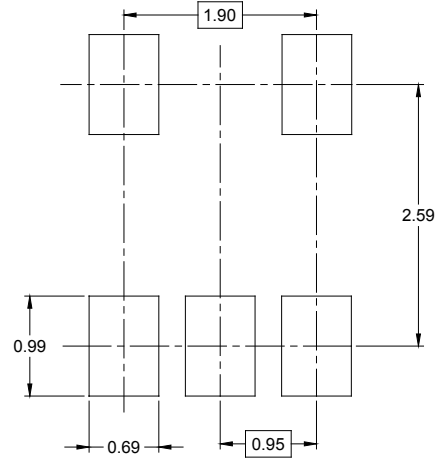
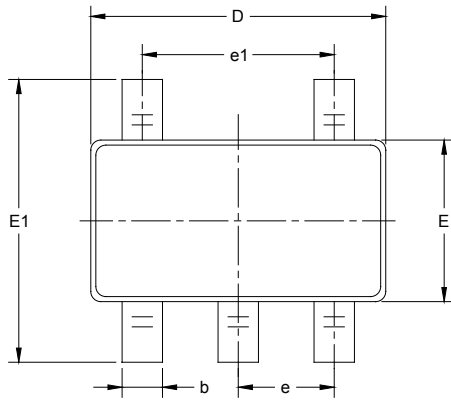

RECOMMENDED LAND PATTERN (Unit: mm)

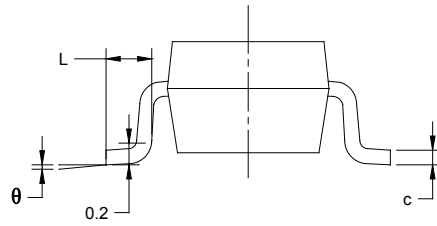
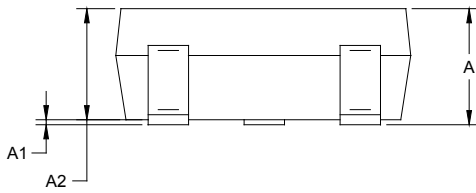

Symbol	Dimensions In Millimeters		Dimensions In Inches	
	MIN	MAX	MIN	MAX
A	1.050	1.250	0.041	0.049
A1	0.000	0.100	0.000	0.004
A2	1.050	1.150	0.041	0.045
b	0.300	0.500	0.012	0.020
c	0.100	0.200	0.004	0.008
D	2.820	3.020	0.111	0.119
E	1.500	1.700	0.059	0.067
E1	2.650	2.950	0.104	0.116
e	0.950 BSC		0.037 BSC	
e1	1.900 BSC		0.075 BSC	
L	0.300	0.600	0.012	0.024
θ	0°	8°	0°	8°

PACKAGE OUTLINE DIMENSIONS

SOT-89-3

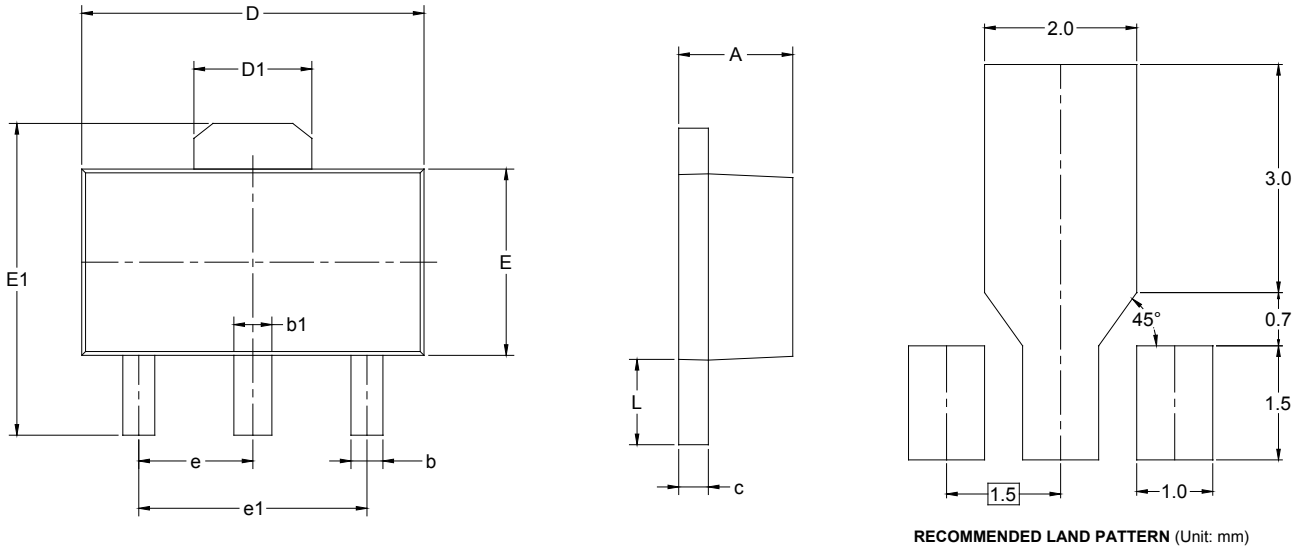

RECOMMENDED LAND PATTERN (Unit: mm)

Symbol	Dimensions In Millimeters		Dimensions In Inches	
	MIN	MAX	MIN	MAX
A	1.400	1.600	0.055	0.063
b	0.320	0.520	0.013	0.020
b1	0.400	0.580	0.016	0.023
c	0.350	0.440	0.014	0.017
D	4.400	4.600	0.173	0.181
D1	1.550 REF		0.061 REF	
E	2.300	2.600	0.091	0.102
E1	3.940	4.250	0.155	0.167
e	1.500 TYP		0.060 TYP	
e1	3.000 TYP		0.118 TYP	
L	0.900	1.200	0.035	0.047

PACKAGE INFORMATION

TAPE AND REEL INFORMATION

REEL DIMENSIONS



TAPE DIMENSIONS



NOTE: The picture is only for reference. Please make the object as the standard.

KEY PARAMETER LIST OF TAPE AND REEL

Package Type	Reel Diameter	Reel Width W1 (mm)	A0 (mm)	B0 (mm)	K0 (mm)	P0 (mm)	P1 (mm)	P2 (mm)	W (mm)	Pin1 Quadrant
SOT-23	7"	9.5	3.15	2.77	1.22	4.0	4.0	2.0	8.0	Q3
SOT-23-5	7"	9.5	3.20	3.20	1.40	4.0	4.0	2.0	8.0	Q3
SOT-89-3	7"	13.2	4.85	4.45	1.85	4.0	8.0	2.0	12.0	Q3

DD0001

PACKAGE INFORMATION

CARTON BOX DIMENSIONS



NOTE: The picture is only for reference. Please make the object as the standard.

KEY PARAMETER LIST OF CARTON BOX

Reel Type	Length (mm)	Width (mm)	Height (mm)	Pizza/Carton
7" (Option)	368	227	224	8
7"	442	410	224	18

DD0002