

OB2358

Freq Shuffling

Current Mode PWM Power Switch

GENERAL INFORMATION

Pin Configuration

The OB2358 is offered in DIP8 package as shown below.

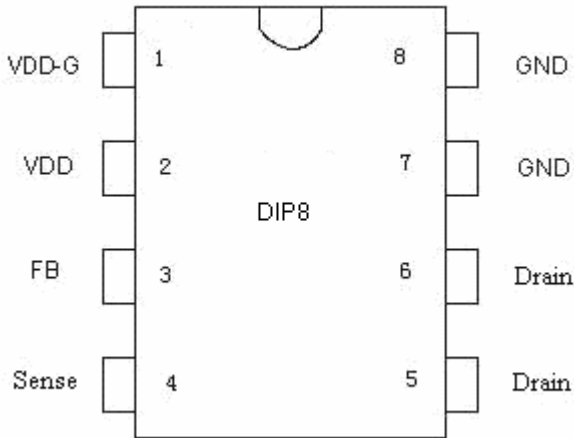

Ordering Information

Part Number	Description
OB2358AP	DIP8, Pb-free

Package Dissipation Rating

Package	R θ JA (°C/W)
DIP8	75

Note: Drain Pin Connected to 100mm² PCB copper clad.

Absolute Maximum Ratings

Parameter	Value
Drain Voltage (off state)	-0.3V to BV _{dss}
VDD Voltage	-0.3V to 30 V
VDD-G Input Voltage	-0.3V to 30 V
VDD Clamp Continuous Current	10mA
FB Input Voltage	-0.3 to 7V
Sense Input Voltage	-0.3 to 7V
Min/Max Operating Junction Temperature T _J	-20 to 150°C
Min/Max Storage Temperature T _{stg}	-55 to 150°C
Lead Temperature (Soldering, 10secs)	260°C

Note: Stresses beyond those listed under "absolute maximum ratings" may cause permanent damage to the device. These are stress ratings only, functional operation of the device at these or any other conditions beyond those indicated under "recommended operating conditions" is not implied. Exposure to absolute maximum-rated conditions for extended periods may affect device reliability.

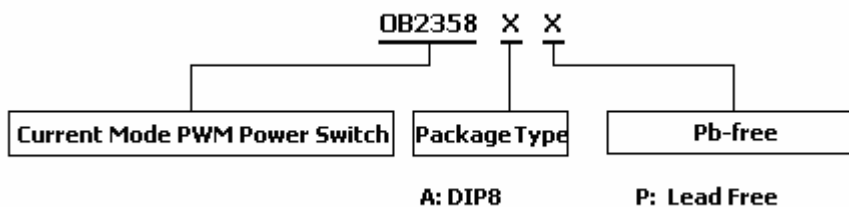

Marking Information

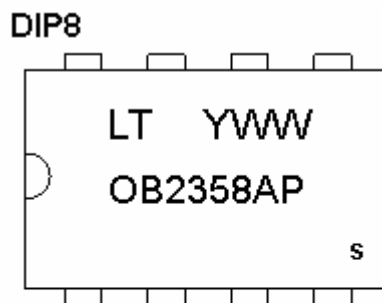

Y: Year Code(0-9)
 WW: Week Code(01-52)
 A: DIP8 Package
 P: Pb-free Package
 S: Internal Code(Optional)

TERMINAL ASSIGNMENTS

Pin Name	I/O	Description
GND	P	Ground
FB	I	Feedback input pin. The PWM duty cycle is determined by voltage level into this pin and the current-sense signal at Pin 4.
VDD-G	P	Internal Gate Driver Power Supply
SENSE	I	Current sense input
VDD	P	IC DC power supply Input
Drain	O	HV MOSFET Drain Pin. The Drain pin is connected to the primary lead of the transformer

BLOCK DIAGRAM

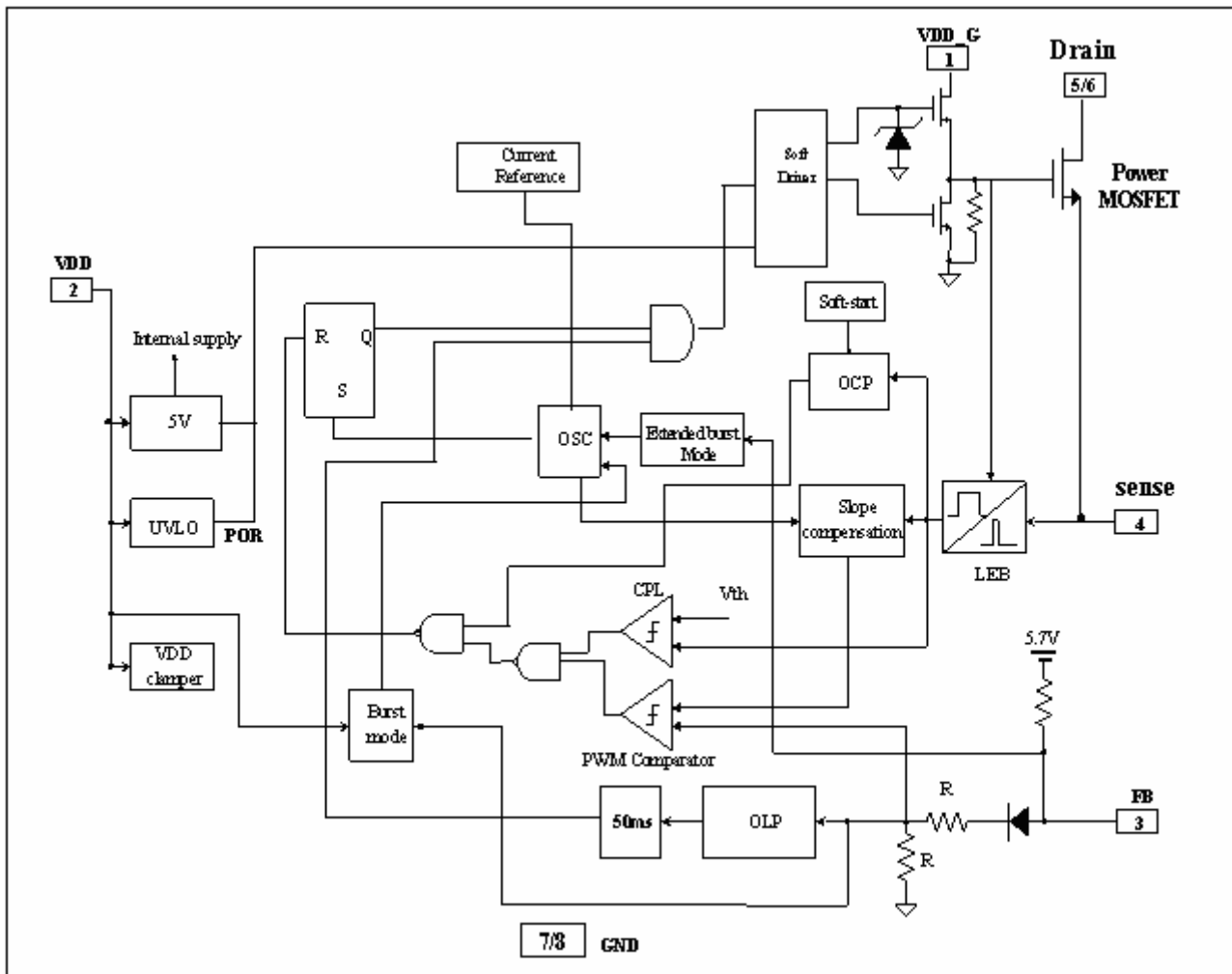

ELECTRICAL CHARACTERISTICS

(T_A = 25°C, VDD=16V, if not otherwise noted)

Symbol	Parameter	Test Conditions	Min	Typ	Max	Unit
Supply Voltage (VDD)						
I _{startup}	VDD Start up Current	VDD=14.5V, Measure Leakage current into VDD		5	20	uA
I _{VDD Operation}	Operation Current	V _{FB} =3V		1.6		mA
UVLO(ON)	VDD Under Voltage Lockout Enter		8.7	9.7	10.7	V
UVLO(OFF)	VDD Under Voltage Lockout Exit (Recovery)		14.6	15.8	17.0	V
OVP(ON)	Over voltage protection voltage	CS=0V,FB=3V Ramp up VDD until gate clock is off	27.0	28.5	30.0	V
VDD_Clamp	VDD Zener Clamp Voltage	I _{DD} = 10 mA		30		V
Feedback Input Section(FB Pin)						
V _{FB_Open}	V _{FB} Open Loop Voltage		5.4	5.7	6.0	V
I _{FB_Short}	FB pin short circuit current	Short FB pin to GND and measure current		1.45		mA
V _{TH_0D}	Zero Duty Cycle FB Threshold Voltage			0.8		V
V _{TH_PL}	Power Limiting FB Threshold Voltage			3.7		V
T _{D_PL}	Power limiting Debounce Time			50		mSec
Z _{FB_IN}	Input Impedance			4		Kohm
Current Sense Input(Sense Pin)						
Soft start time				4		ms
T _{blanking}	Leading edge blanking time			270		ns
Z _{SENSE_IN}	Input Impedance			40		Kohm
T _{D_OC}	Over Current Detection and Control Delay	From Over Current Occurs till the Gatedrive output start to turn off		120		nSec
V _{TH_OC}	Internal Current Limiting Threshold Voltage	FB=3.3V	0.72	0.77	0.82	V
Oscillator						
F _{OSC}	Normal Oscillation Frequency		45	50	55	KHZ
Δf_Temp	Frequency Temperature Stability			5		%

OB2358
Freq Shuffling

Current Mode PWM Power Switch

Δf_{VDD}	Frequency Voltage Stability			5		%
D_max	Maximum duty cycle	FB=3.3V, CS =0V	70	80	90	%
F_Burst	Burst Mode Base Frequency			22		KHZ
Mosfet Section						
BVdss	MOSFET Drain-Source Breakdown Voltage		600			V
Rdson	Static, Id=1.0A			4.4	5.5	Ω
Frequency Shuffling						
Δf_{OSC}	Frequency Modulation range /Base frequency		-4		4	%

CHARACTERIZATION PLOTS

(The characteristic graphs are normalized at Ta=25°C)

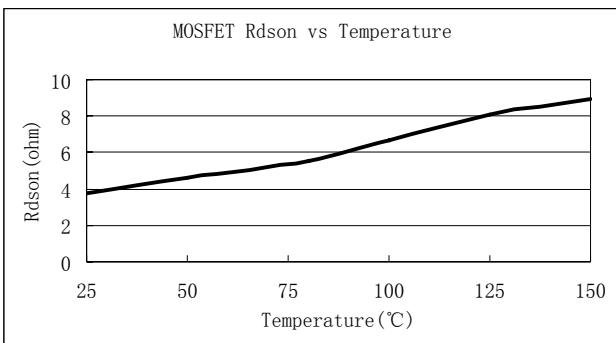
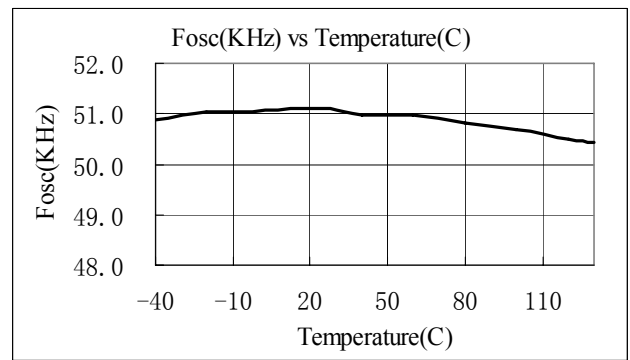
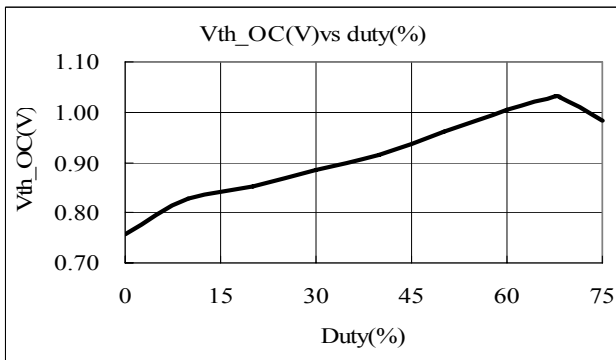
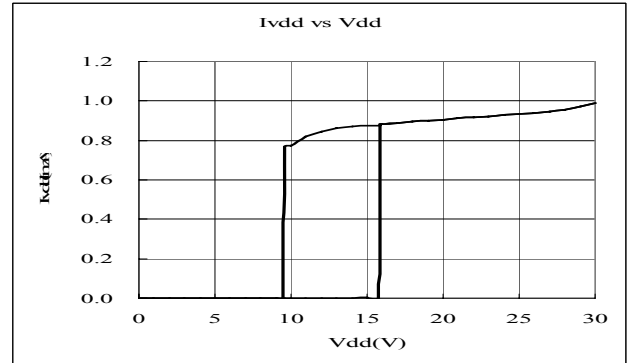
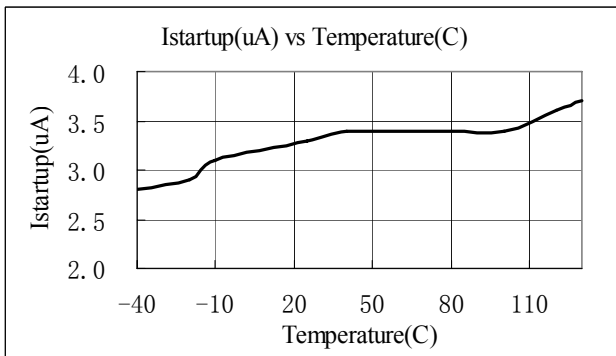
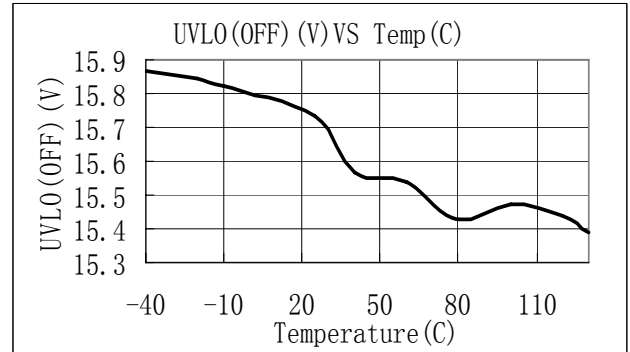
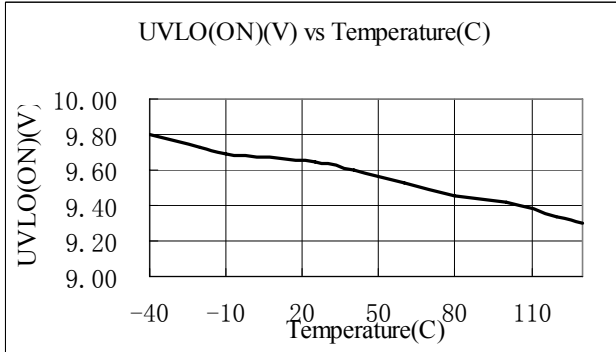

OPERATION DESCRIPTION

The OB2358 is a low power off-line SMPS Switcher optimized for off-line flyback converter applications in sub 27W power range. The 'Extended burst mode' control greatly reduces the standby power consumption and helps the design easily to meet the international power conservation requirements.

- **Startup Current and Start up Control**

Startup current of OB2358 is designed to be very low so that VDD could be charged up above UVLO threshold level and device starts up quickly. A large value startup resistor can therefore be used to minimize the power loss yet achieve a reliable startup in application. For AC/DC adaptor with universal input range design, a 2 M Ω , 1/8 W startup resistor could be used together with a VDD capacitor to provide a fast startup and yet low power dissipation design solution.

- **Operating Current**

The Operating current of OB2358 is low at 2mA. Good efficiency is achieved with OB2358 low operating current together with the 'Extended burst mode' control features.

- **Soft Start**

OB2358 features an internal 4ms soft start to soften the electrical stress occurring in the power supply during startup. It is activated during the power on sequence. As soon as VDD reaches UVLO(OFF), the peak current is gradually increased from nearly zero to the maximum level of 0.77V. Every restart up is followed by a soft start.

- **Frequency shuffling for EMI improvement**

The frequency Shuffling (switching frequency modulation) is implemented in OB2358. The oscillation frequency is modulated so that the tone energy is spread out. The spread spectrum minimizes the conduction band EMI and therefore eases the system design.

- **Extended Burst Mode Operation**

At light load or zero load condition, most of the power dissipation in a switching mode power supply is from switching loss on the MOSFET, the core loss of the transformer and the loss on the snubber circuit. The magnitude of power loss is in proportion to the switching frequency. Lower switching frequency leads to the reduction on the power loss and thus conserves the energy.

The switching frequency is internally adjusted at no load or light load condition. The switch frequency reduces at light/no load condition to improve the conversion efficiency. At light load or no load condition, the FB input drops below burst mode threshold level and device enters Burst Mode control. The Gate drive output switches only when VDD voltage drops below a preset level and FB input is active to output an on state. Otherwise the gate drive remains at off state to minimize the switching loss and reduces the standby power consumption to the greatest extend.

The switching frequency control also eliminates the audio noise at any loading conditions.

- **Oscillator Operation**

The switching frequency of OB2358 is internally fixed at 50KHZ. No external frequency setting components are required for PCB design simplification.

- **Current Sensing and Leading Edge Blanking**

Cycle-by-Cycle current limiting is offered in OB2358 current mode PWM control. The switch current is detected by a sense resistor into the sense pin. An internal leading edge blanking circuit chops off the sensed voltage spike at initial internal power MOSFET on state due to snubber diode reverse recovery and surge gate current of internal power MOSFET so that the external RC filtering on sense input is no longer needed. The current limiting comparator is disabled and cannot turn off the internal power MOSFET during the blanking period. The PWM duty cycle is determined by the current sense input voltage and the FB input voltage.

- **Internal Synchronized Slope Compensation**

Built-in slope compensation circuit adds voltage ramp onto the current sense input voltage for PWM generation. This greatly improves the close loop stability at CCM and prevents the sub-harmonic oscillation and thus reduces the output ripple voltage.

- **Drive**

The internal power MOSFET in OB2358 is driven by a dedicated gate driver for power switch control. Too weak the gate drive strength results in higher conduction and switch loss of MOSFET while too strong gate drive results the compromise of EMI.

A good tradeoff is achieved through the built-in totem pole gate design with right output strength and dead time control. The low idle loss and good EMI system design is easier to achieve with this dedicated control scheme.

In addition to the gate drive control scheme mentioned, the gate drive strength can also be adjusted externally by a resistor connected between VDD and VDDG, the falling edge of the Drain output can be well controlled. It provides great flexibility for system EMI design.

- **Protection Controls**

Good power supply system reliability is achieved with its rich protection features including Cycle-by-

Cycle current limiting (OCP), Over Load Protection (OLP) and over voltage clamp, Under Voltage Lockout on VDD (UVLO).

With On-Bright Proprietary technology, the OCP is line voltage compensated to achieve constant output power limit over the universal input voltage range.

At overload condition when FB input voltage exceeds power limit threshold value for more than TD_PL, control circuit reacts to shut down the switcher. Switcher restarts when VDD voltage drops below UVLO limit.

VDD is supplied by transformer auxiliary winding output. It is clamped when VDD is higher than 30V. The output of OB2358 is shut down when VDD drops below UVLO_ON limit and Switcher enters power on start-up sequence thereafter.

PACKAGE MECHANICAL DATA

8-Pin Plastic DIP

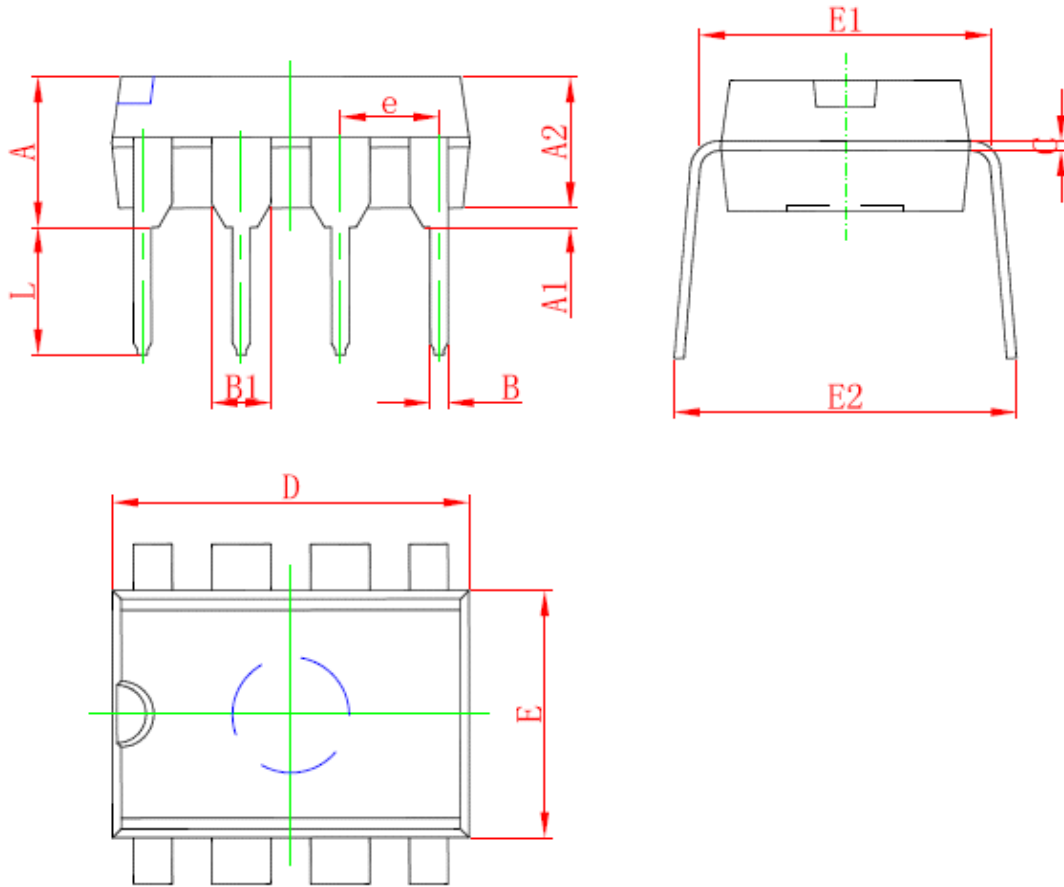

Symbol	Dimensions In Millimeters		Dimensions In Inches	
	Min	Max	Min	Max
A	3.710	4.310	0.146	0.170
A1	0.500		0.020	
A2	3.200	3.600	0.126	0.142
B	0.350	0.650	0.014	0.026
B1	1.524 (BSC)		0.060 (BSC)	
C	0.204	0.360	0.008	0.014
D	9.000	9.500	0.354	0.374
E	6.200	6.600	0.244	0.260
E1	7.320	7.920	0.288	0.312
e	2.540 (BSC)		0.100 (BSC)	
L	3.000	3.600	0.118	0.142
E2	8.200	9.000	0.323	0.354

