

### GENERAL DESCRIPTION

The SGM05UB1B3 is an ultra-low capacitance ESD protection device. As a new generation TVS, it is applied to protect circuits from electrostatic discharge.

### FEATURES

- **High ESD Withstand Voltage:**  
IEC 61000-4-2: ±30kV (Air)  
IEC 61000-4-2: ±30kV (Contact)
- **Low Profile Package:** XTDFN-0.6×0.3-2L and UTDFN-1×0.6-2L
- **Working Voltage:** 5V (MAX)
- **Rated Peak Pulse Current:** 4.2A
- **Channel Input Capacitance:** 0.5pF (TYP)

### APPLICATIONS

Cellular Handsets and Accessories  
Computers and Peripherals  
Audio and Video Equipment  
SIM Card Protection  
Portable Electronics  
10/100Mbit/s Ethernet

### ABSOLUTE MAXIMUM RATINGS

PARAMETER	SYMBOL	VALUE	UNITS
Peak Pulse Current ( $t_p$ : 8/20 $\mu$ s)	$I_{PPM}$	4.2	A
ESD IEC 61000-4-2 (Air)	$V_{ESD}$	±30	kV
ESD IEC 61000-4-2 (Contact)		±30	
Operating Temperature Range	$T_{OP}$	-40 to +125	°C
Storage Temperature Range	$T_{STG}$	-55 to +150	°C
Lead Temperature (Soldering, 10s)		+260	°C

Stresses beyond those listed in Absolute Maximum Ratings may cause permanent damage to the device. Exposure to absolute maximum rating conditions for extended periods may affect reliability.

### PRODUCT SUMMARY

$V_{RWM}$ (MAX)	$I_{PPM}$ (MAX)	$C_{IN}$ (TYP)
5V	4.2A	0.5pF

### PIN CONFIGURATION

(TOP VIEW)

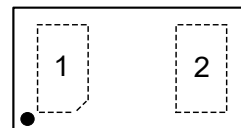

XTDFN-0.6×0.3-2L

(TOP VIEW)

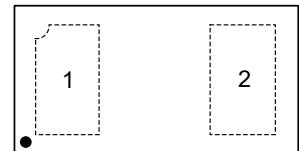

UTDFN-1×0.6-2L

### EQUIVALENT CIRCUIT



**PACKAGE/ORDERING INFORMATION**

MODEL	PACKAGE DESCRIPTION	SPECIFIED TEMPERATURE RANGE	ORDERING NUMBER	PACKAGE MARKING	PACKING OPTION
SGM05UB1B3	XTDFN-0.6×0.3-2L	-40°C to +125°C	SGM05UB1B3XXEI2G/TR	02	Tape and Reel, 10000
	UTDFN-1×0.6-2L	-40°C to +125°C	SGM05UB1B3XUEG2G/TR	00X	Tape and Reel, 10000

**MARKING INFORMATION**

NOTE: Fixed character for 02.

**XTDFN-0.6×0.3-2L**

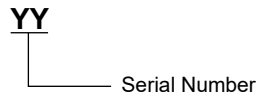

NOTE: X = Date Code.

**UTDFN-1×0.6-2L**

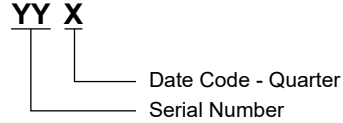

Green (RoHS & HSF): SG Micro Corp defines "Green" to mean Pb-Free (RoHS compatible) and free of halogen substances. If you have additional comments or questions, please contact your SGMICRO representative directly.

**DISCLAIMER**

SG Micro Corp reserves the right to make any change in circuit design, or specifications without prior notice.

**ELECTRICAL PARAMETERS**

SYMBOL	PARAMETER
$V_{RWM}$	Reverse Stand-Off Voltage
$V_{BR}$	Reverse Breakdown Voltage
$I_R$	Reverse Leakage Current
$I_R @ BR$	Reverse Leakage Current @ Breakdown
$V_C$	Clamping Voltage @ $I_{PP}$
$I_{PP}$	Peak Pulse Current
$R_{DYN}$	Dynamic Resistance

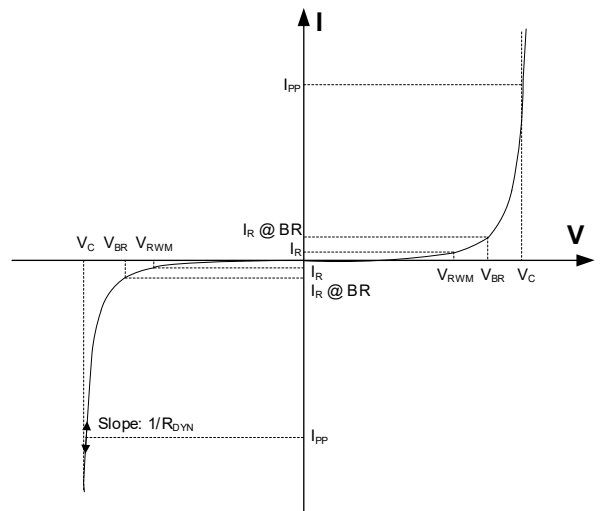

**ELECTRICAL CHARACTERISTICS**

(T<sub>A</sub> = +25°C, unless otherwise noted.)

PARAMETER	SYMBOL	CONDITIONS	MIN	TYP	MAX	UNITS
Reverse Stand-Off Voltage	V <sub>RWM</sub>				5	V
Reverse Breakdown Voltage	V <sub>BR</sub>	I <sub>R</sub> = 1mA	6	7.2	8.5	V
Reverse Leakage Current	I <sub>R</sub>	V <sub>R</sub> = 5V			500	nA
Channel Input Capacitance	C <sub>IN</sub>	V <sub>R</sub> = 0V, f = 1MHz		0.5	0.7	pF
Surge Clamping Voltage <sup>(1)</sup>	V <sub>C-Surge</sub>	I <sub>PPM</sub> = 4.2A		11.1		V
ESD Clamping Voltage <sup>(2)</sup>	V <sub>C</sub>	I <sub>TLP</sub> = 8A (Equivalent IEC 61000-4-2 Contact +4kV)		12		V
		I <sub>TLP</sub> = 16A (Equivalent IEC 61000-4-2 Contact +8kV)		15.5		V
Dynamic Resistance <sup>(2)</sup>	R <sub>DYN</sub>	t <sub>p</sub> = 100ns		0.44		Ω

NOTES:

1. Non-repetitive current pulse 8/20μs exponential decay waveform according to IEC 61000-4-5, 2Ω source impedance.
2. Non-repetitive current pulse. Transmission line pulse (TLP) t<sub>p</sub> = 100ns, square pulse.

Positive 8kV:

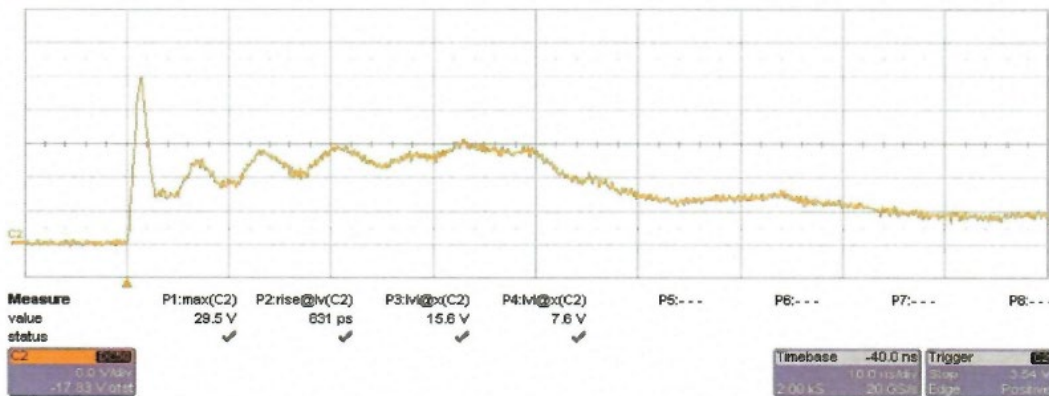

Figure 1. Typical Pulses ESD 8kV Contact per IEC 61000-4-2

Negative 8kV:

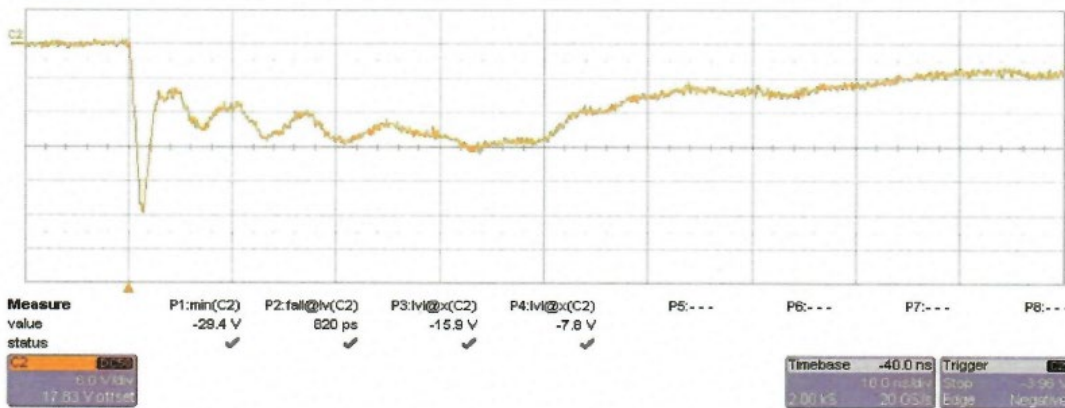
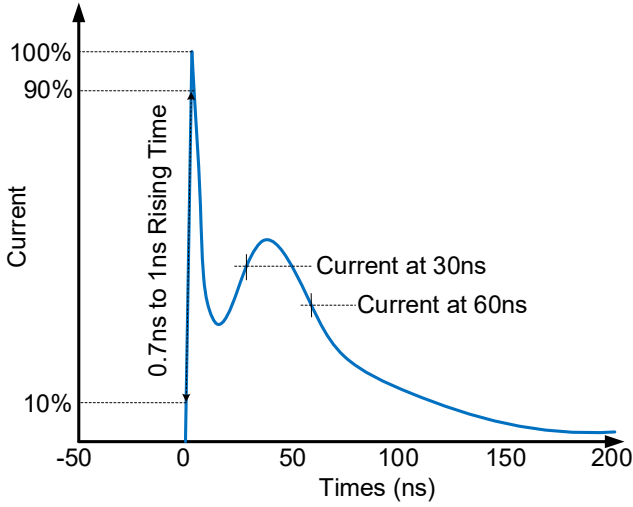

Figure 2. Typical Pulses ESD -8kV Contact per IEC 61000-4-2

TYPICAL PERFORMANCE CHARACTERISTICS

ESD Pulse Waveform per IEC 61000-4-2



8/20µs Waveform per IEC 61000-4-5

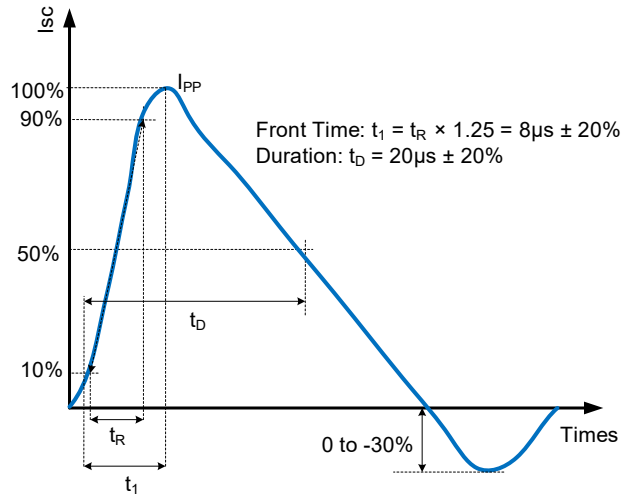

TLP\_Pin1(-) to Pin2(+)

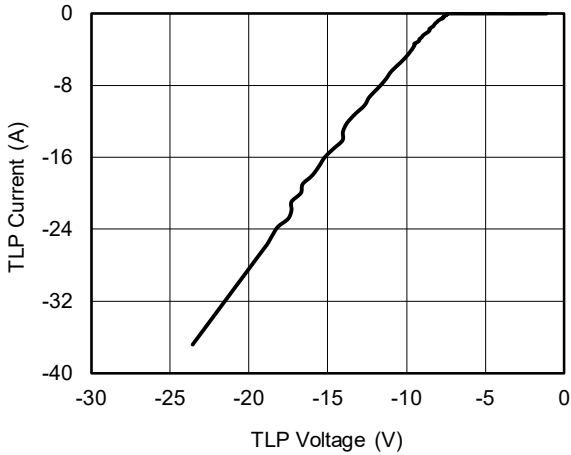

TLP\_Pin1(+) to Pin2(-)

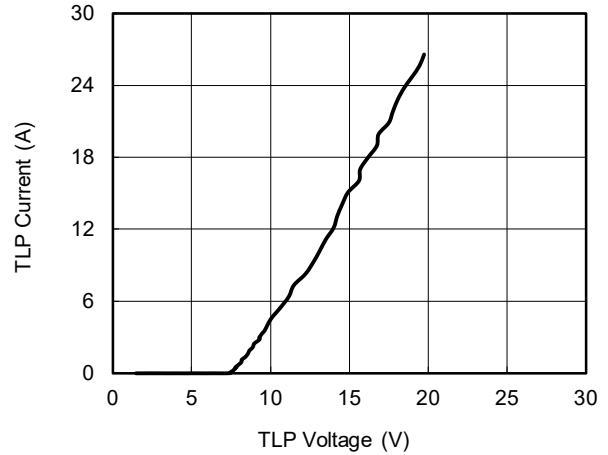

IV Curve

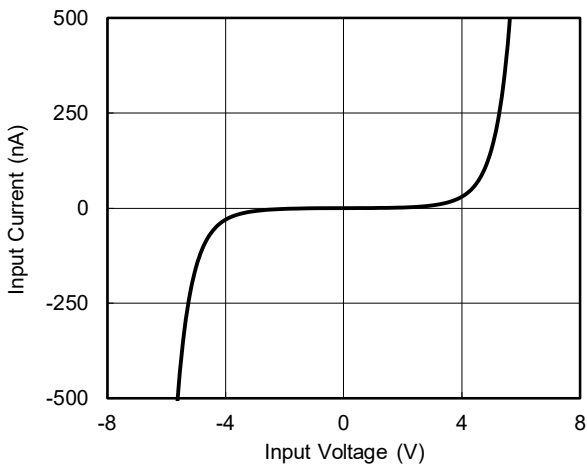

Capacitance vs. Reverse voltage

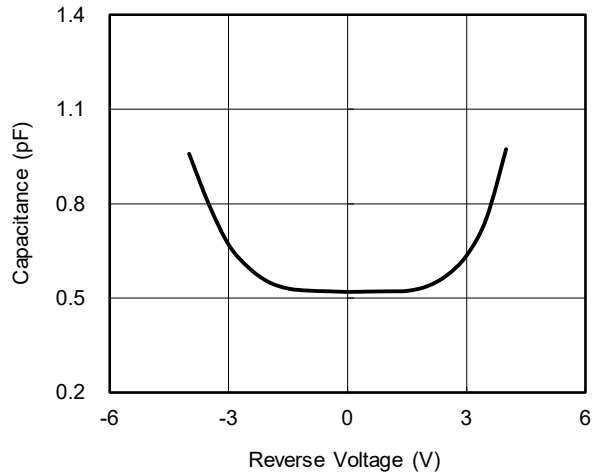

## TYPICAL PERFORMANCE CHARACTERISTICS (continued)

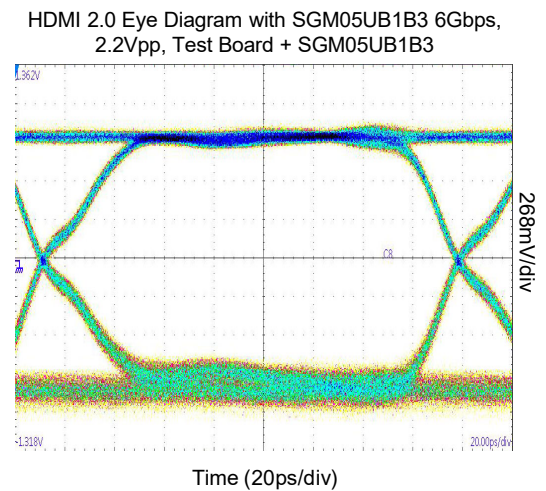
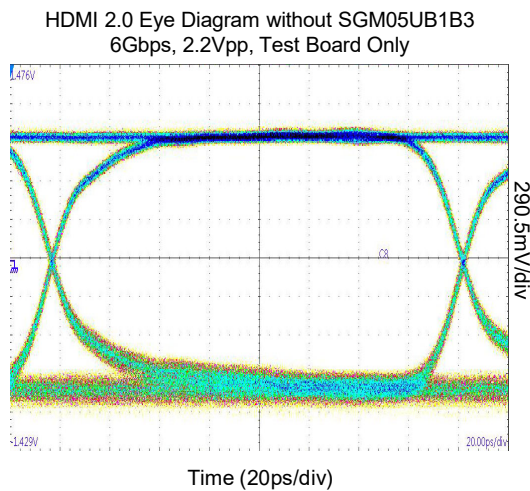

## APPLICATION INFORMATION

The SGM05UB1B3 is applied to offer a bidirectional line in order to eliminate ESD events on high-speed signals. The device is a good choice for lines with positive and negative signal polarity relative to the ground.

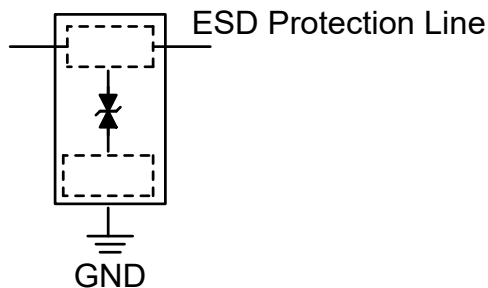

The recommended guidelines are as follows:

### 1. TVS Placement

Place the TVS as close as possible to the input connector.

### 2. TVS's Trace Layout

Avoid running protected traces in parallel with unprotected traces.

Minimize the path length between the TVS and the protected line.

Minimize parallel signal path length.

Route the protected traces as straight as possible.

### 3. GND Layout

Avoid using a common ground point shared with the TVS transient return path.

Minimize the length of the TVS transient return path to ground.

Use ground vias as close as possible to the TVS transient return to ground.

**REVISION HISTORY**

NOTE: Page numbers for previous revisions may differ from page numbers in the current version.

<b>FEBRUARY 2025 – REV.A to REV.A.1</b>	<b>Page</b>
Updated product summary .....	1
Added typical performance characteristics figures .....	5

---

<b>Changes from Original (DECEMBER 2023) to REV.A</b>	<b>Page</b>
Changed from Product Preview to Production Data .....	All

---

PACKAGE OUTLINE DIMENSIONS

XTDFN-0.6x0.3-2L

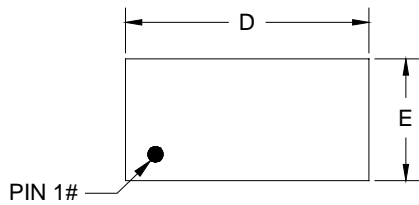

TOP VIEW

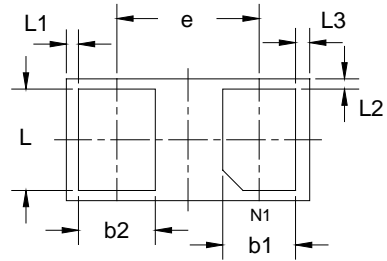

BOTTOM VIEW

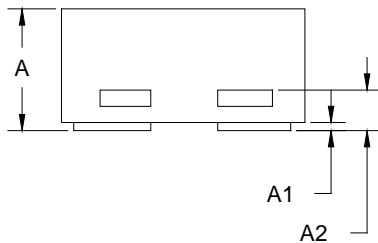

SIDE VIEW

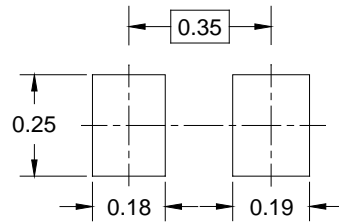

RECOMMENDED LAND PATTERN (Unit: mm)

Symbol	Dimensions In Millimeters		
	MIN	MOD	MAX
A	0.280	0.300	0.320
A1	0.000	0.020	0.050
A2	0.050	0.100	0.150
b1	0.130	0.180	0.230
b2	0.140	0.190	0.240
D	0.550	0.600	0.650
E	0.250	0.300	0.350
e	0.350 BSC		
L	0.200	0.250	0.300
L1	0.030 BSC		
L2	0.025 BSC		
L3	0.035 BSC		

NOTE: This drawing is subject to change without notice.

# PACKAGE INFORMATION

## PACKAGE OUTLINE DIMENSIONS

### UTDFN-1x0.6-2L

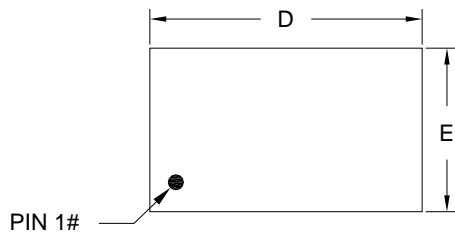

TOP VIEW

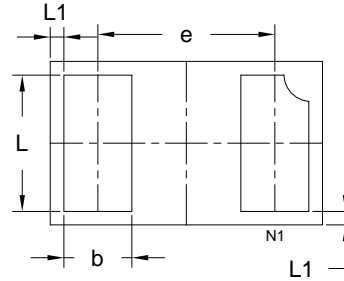

BOTTOM VIEW

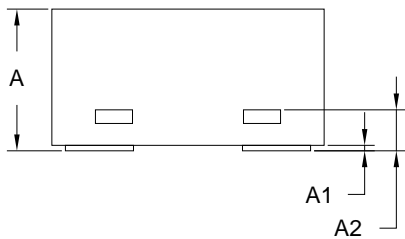

SIDE VIEW

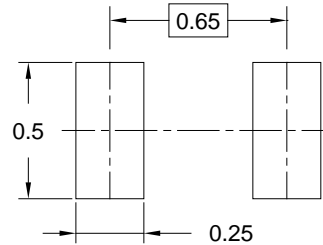

RECOMMENDED LAND PATTERN (Unit: mm)

Symbol	Dimensions In Millimeters		
	MIN	MOD	MAX
A	0.450	0.500	0.550
A1	0.000	-	0.050
A2	0.120	0.150	0.180
b	0.200	0.250	0.300
D	0.950	1.000	1.050
E	0.550	0.600	0.650
e	0.650 BSC		
L	0.450	0.500	0.550
L1	0.050 REF		

NOTE: This drawing is subject to change without notice.

## TAPE AND REEL INFORMATION

### REEL DIMENSIONS

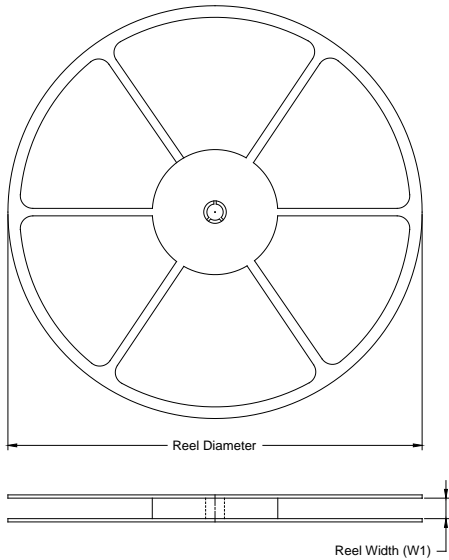

### TAPE DIMENSIONS

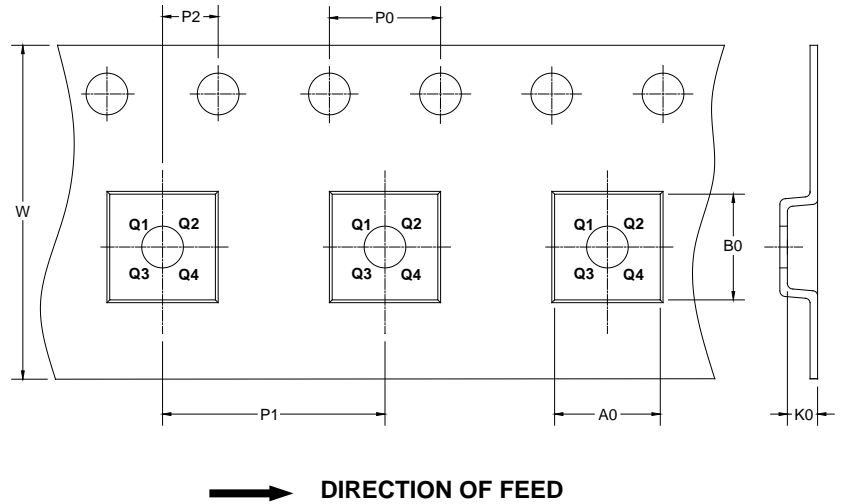

NOTE: The picture is only for reference. Please make the object as the standard.

### KEY PARAMETER LIST OF TAPE AND REEL

Package Type	Reel Diameter	Reel Width W1 (mm)	A0 (mm)	B0 (mm)	K0 (mm)	P0 (mm)	P1 (mm)	P2 (mm)	W (mm)	Pin1 Quadrant
XTDFN-0.6x0.3-2L	7"	8.6	0.37	0.67	0.34	4.0	2.0	2.0	8.0	Q1
UTDFN-1x0.6-2L	7"	8.6	0.70	1.15	0.57	4.0	2.0	2.0	8.0	Q1

D00001

# PACKAGE INFORMATION

## CARTON BOX DIMENSIONS

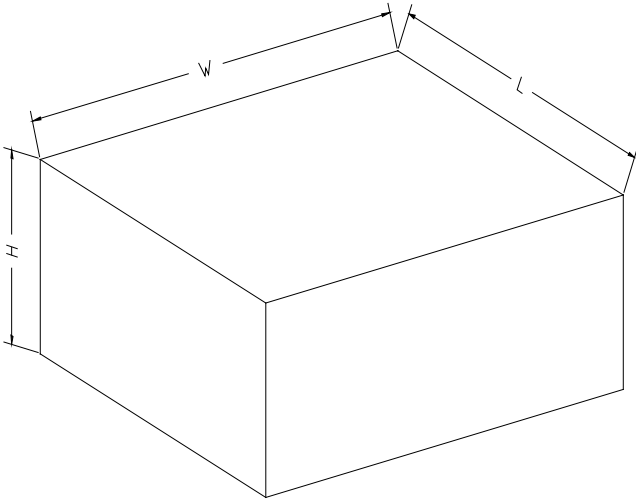

NOTE: The picture is only for reference. Please make the object as the standard.

## KEY PARAMETER LIST OF CARTON BOX

Reel Type	Length (mm)	Width (mm)	Height (mm)	Pizza/Carton
7" (Option)	368	227	224	8
7"	442	410	224	18

DD0002