



# SGM8713A-1/SGM8713B-1

## Nano-Power, Small Size, Low Voltage Comparators

### GENERAL DESCRIPTION

The SGM8713A-1 and SGM8713B-1 are single, nano-power, small size comparators. They are optimized for low voltage operation from 1.6V to 5.5V single supply, and consume only 300nA quiescent current. Both devices are packaged in a space-saving XTDFN package, which is 0.8mm × 0.8mm. The combination of these features makes them good choices for smart battery-powered equipment. Meanwhile, the SGM8713A-1 and SGM8713B-1 also have a great trade-off between low power and high speed, whose propagation delay is only 5μs. This results in a continuous system monitoring and quick respond to fault conditions without too much battery power dissipation.

These devices have different output structures. The SGM8713A-1 has a push-pull output structure, which can easily drive the LED, resistive or capacitive load with the ability of sourcing or sinking the current for the level of milliamp. The SGM8713B-1 has an open-drain output structure, which needs an external pull-up resistor to output a high level of  $V_S$  or a voltage below  $V_S$ . So it enables conversion from bipolar to single-ended signals and level translation. A clamp diode is designed between the OUT pin and the + $V_S$  pin to avoid the SGM8713A-1 and SGM8713B-1 being damaged when the output voltage exceeds the power supply.

The SGM8713A-1 and SGM8713B-1 are both available in a Green XTDFN-0.8×0.8-4L package. They are rated over the -40 °C to +125 °C operating temperature range.

### FEATURES

- **Ultra-Low Supply Current: 300nA (TYP)**
- **Low Propagation Delay: 5μs (TYP)**
- **Supply Voltage Range: 1.6V to 5.5V**
- **Rail-to-Rail Input Common Mode Voltage**
- **Different Output Structures**
  - ◆ **Push-Pull Output: SGM8713A-1**
  - ◆ **Open-Drain Output: SGM8713B-1**
- **Internal Hysteresis: 6mV (TYP)**
- **-40°C to +125°C Operating Temperature Range**
- **Available in a Green XTDFN-0.8×0.8-4L Package**

### APPLICATIONS

Cell Phones  
Battery-Powered Equipment  
IR Receivers

**PACKAGE/ORDERING INFORMATION**

| MODEL      | PACKAGE DESCRIPTION | SPECIFIED TEMPERATURE RANGE | ORDERING NUMBER     | PACKAGE MARKING | PACKING OPTION       |
|------------|---------------------|-----------------------------|---------------------|-----------------|----------------------|
| SGM8713A-1 | XTDFN-0.8×0.8-4L    | -40°C to +125°C             | SGM8713A-1XXEB4G/TR | AX              | Tape and Reel, 10000 |
| SGM8713B-1 | XTDFN-0.8×0.8-4L    | -40°C to +125°C             | SGM8713B-1XXEB4G/TR | BX              | Tape and Reel, 10000 |

**MARKING INFORMATION**

NOTE: X = Date Code.

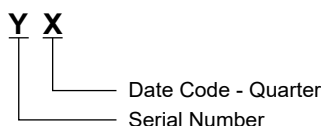

Green (RoHS & HSF): SG Micro Corp defines "Green" to mean Pb-Free (RoHS compatible) and free of halogen substances. If you have additional comments or questions, please contact your SGMICRO representative directly.

**ABSOLUTE MAXIMUM RATINGS**

- Supply Voltage, +V<sub>S</sub> to -V<sub>S</sub> ..... 6V
- Voltage at Input/Output Pins ..... (-V<sub>S</sub>) - 0.3V to (+V<sub>S</sub>) + 0.3V
- Differential Input Voltage, |V<sub>ID</sub>| ..... V<sub>S</sub>
- Junction Temperature ..... +150°C
- Storage Temperature Range ..... -65°C to +150°C
- Lead Temperature (Soldering, 10s) ..... +260°C
- ESD Susceptibility
- HBM ..... 8000V
- CDM ..... 1000V

**RECOMMENDED OPERATING CONDITIONS**

- Supply Voltage Range ..... 1.6V to 5.5V
- Operating Temperature Range ..... -40°C to +125°C

**OVERSTRESS CAUTION**

Stresses beyond those listed in Absolute Maximum Ratings may cause permanent damage to the device. Exposure to absolute maximum rating conditions for extended periods

may affect reliability. Functional operation of the device at any conditions beyond those indicated in the Recommended Operating Conditions section is not implied.

**ESD SENSITIVITY CAUTION**

This integrated circuit can be damaged if ESD protections are not considered carefully. SGMICRO recommends that all integrated circuits be handled with appropriate precautions. Failure to observe proper handling and installation procedures can cause damage. ESD damage can range from subtle performance degradation to complete device failure. Precision integrated circuits may be more susceptible to damage because even small parametric changes could cause the device not to meet the published specifications.

**DISCLAIMER**

SG Micro Corp reserves the right to make any change in circuit design, or specifications without prior notice.

**PIN CONFIGURATION**

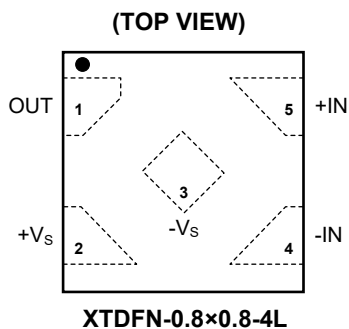

**PIN DESCRIPTION**

| PIN | NAME | FUNCTION               |
|-----|------|------------------------|
| 1   | OUT  | Output.                |
| 2   | +Vs  | Positive Power Supply. |
| 3   | -Vs  | Negative Power Supply. |
| 4   | -IN  | Inverting Input.       |
| 5   | +IN  | Non-Inverting Input.   |

**ELECTRICAL CHARACTERISTICS**

( $V_S = 1.6V$  to  $5V$ ,  $V_{CM} = V_S/2$ , Full =  $-40^\circ C$  to  $+125^\circ C$ , typical values are at  $T_A = +25^\circ C$ , unless otherwise noted.)

| PARAMETER  | SYMBOL     | CONDITIONS  | TEMP          | MIN    | TYP   | MAX   | UNITS |
|--|------------|---|---------------|--------|-------|-------|-------|
| Input Offset Voltage                                       | $V_{OS}$   | $V_{CM} = V_S/2$  | $+25^\circ C$ |        | 1     | 10    | mV    |
|  |            |   | Full          |        |       | 12    |       |
| Hysteresis   | $V_{HYST}$ | $V_{CM} = V_S/2$  | $+25^\circ C$ | 3      | 6     | 8     | mV    |
|  |            |   | Full          | 1.5    |       | 10    |       |
| Input Common Mode Voltage Range                            | $V_{CM}$   |   | Full          | $-V_S$ |       | $V_S$ | V     |
| Input Bias Current   | $I_B$      | $V_S = 5V, V_{CM} = V_S/2$                                    | $+25^\circ C$ |        | 15    |       | pA    |
| Input Offset Current                                       | $I_{OS}$   | $V_S = 5V, V_{CM} = V_S/2$                                    | $+25^\circ C$ |        | 10    |       | pA    |
| Output Voltage High<br>(for SGM8713A-1 Only)               | $V_{OH}$   | $V_S = 5V, I_{OUT} = 3mA$                                     | $+25^\circ C$ | 4.79   | 4.855 |       | V     |
|  |            |   | Full          | 4.75   |       |       |       |
| Output Voltage Low   | $V_{OL}$   | $V_S = 5V, I_{OUT} = -3mA$                                    | $+25^\circ C$ |        | 85    | 150   | mV    |
|  |            |   | Full          |        |       | 175   |       |
| Open-Drain Output Leakage Current<br>(for SGM8713B-1 Only) | $I_{LKG}$  | $V_S = 5V, V_{ID} = +0.1V$ (output high), $V_{PULL-UP} = V_S$ | $+25^\circ C$ |        | 30    |       | pA    |
| Common Mode Rejection Ratio                                | CMRR       | $-V_S < V_{CM} < V_S$   | $+25^\circ C$ | 52     | 69    |       | dB    |
|  |            |   | Full          | 45     |       |       |       |
| Power Supply Rejection Ratio                               | PSRR       | $V_S = 1.6V$ to $5.5V, V_{CM} = V_S/2$                        | $+25^\circ C$ | 66     | 88    |       | dB    |
|  |            |   | Full          | 61     |       |       |       |
| Short-Circuit Current                                      | $I_{SC}$   | $V_S = 5V$ , sourcing (for SGM8713A-1 only)                   | $+25^\circ C$ | 27     | 36    |       | mA    |
|  |            | $V_S = 5V$ , sinking  | $+25^\circ C$ | 39     | 60    |       |       |
| Quiescent Current  | $I_Q$      | $V_S = 5V, I_{OUT} = 0A, V_{ID} = -0.1V$ (output low)         | $+25^\circ C$ |        | 300   | 540   | nA    |
|  |            |   | Full          |        |       | 755   |       |

**SWITCHING CHARACTERISTICS**

( $V_S = 5V, V_{CM} = 2.5V, C_L = 15pF$ , input overdrive =  $100mV$ , typical values are at  $T_A = +25^\circ C$ , unless otherwise noted.)

| PARAMETER                           | SYMBOL    | CONDITIONS                                | TEMP          | MIN | TYP | MAX | UNITS   |
|-------------------------------------|-----------|---|---------------|-----|-----|-----|---------|
| Propagation Delay Time, High-to-Low | $t_{PHL}$ | ( $R_P = 2.5k\Omega$ for SGM8713B-1 only) | $+25^\circ C$ |     | 3   |     | $\mu s$ |
| Propagation Delay Time, Low-to-High | $t_{PLH}$ | ( $R_P = 2.5k\Omega$ for SGM8713B-1 only) | $+25^\circ C$ |     | 5   |     | $\mu s$ |
| Rise Time (for SGM8713A-1 Only)     | $t_R$     | 20% to 80%                                | $+25^\circ C$ |     | 7   |     | ns      |
| Fall Time                           | $t_F$     | 80% to 20%                                | $+25^\circ C$ |     | 15  |     | ns      |
| Power-Up Time                       | $t_{ON}$  |   | $+25^\circ C$ |     | 1   |     | ms      |

**TIMING DIAGRAM**

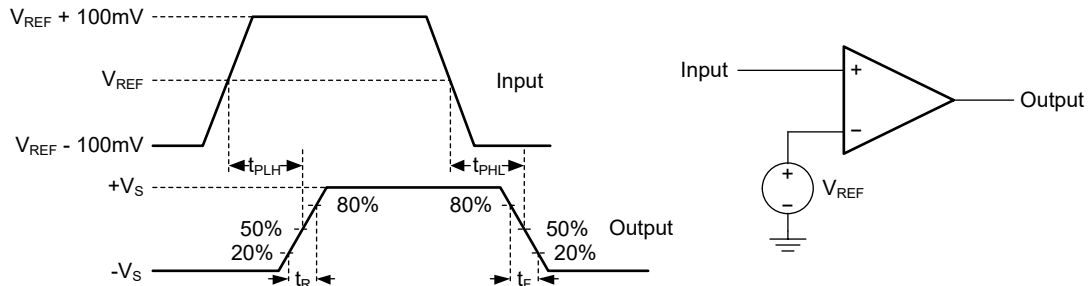

NOTE: The offset voltage and the hysteresis result in the propagation delay of the comparator output.

Figure 1. Propagation Delay Timing Diagram

**TYPICAL PERFORMANCE CHARACTERISTICS**

At  $T_A = +25^\circ\text{C}$ , unless otherwise noted.

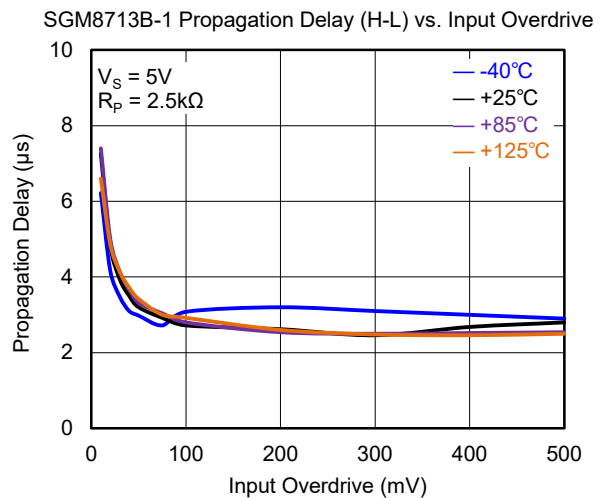
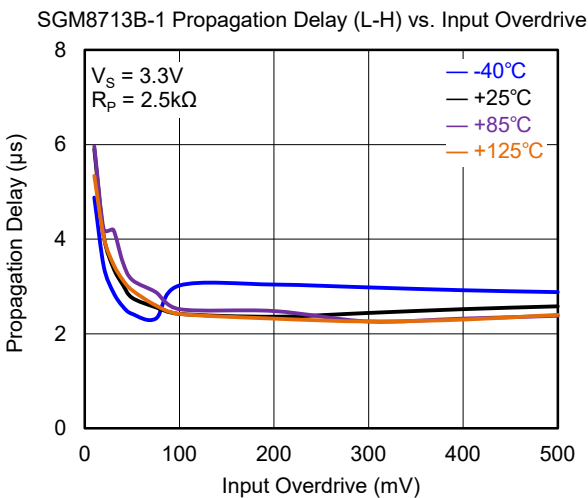
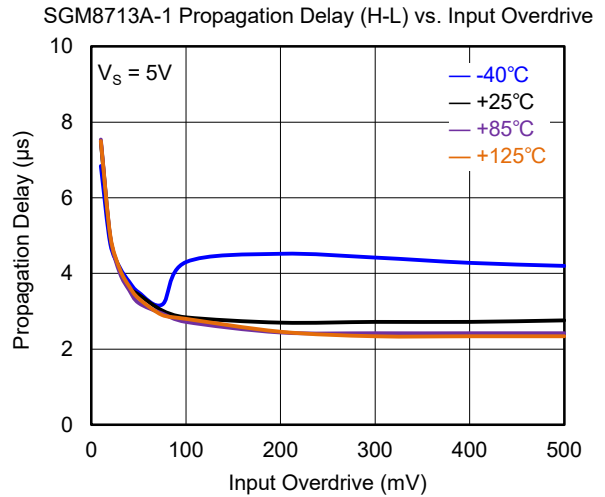
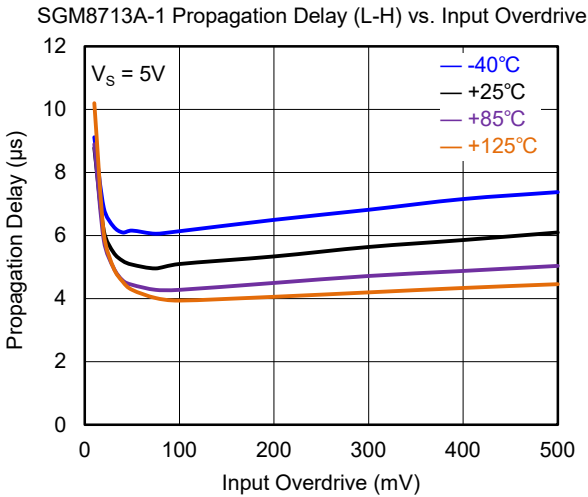
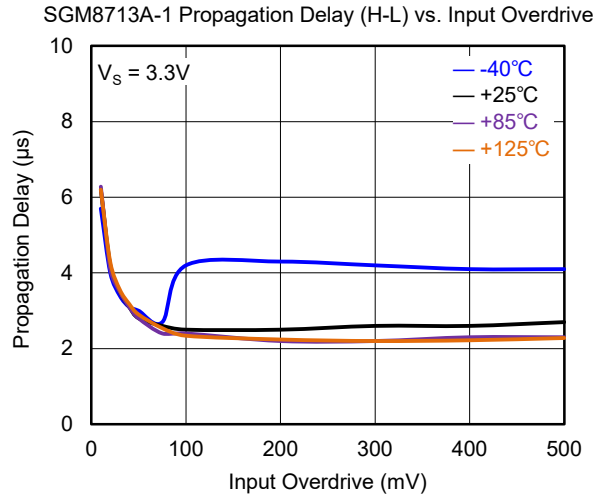
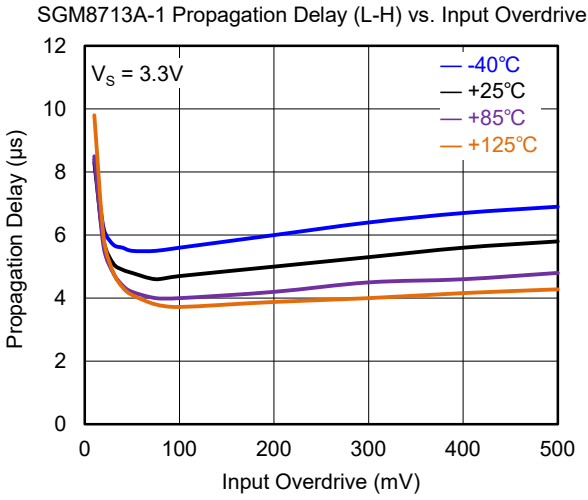

**TYPICAL PERFORMANCE CHARACTERISTICS (continued)**

At  $T_A = +25^\circ\text{C}$ , unless otherwise noted.

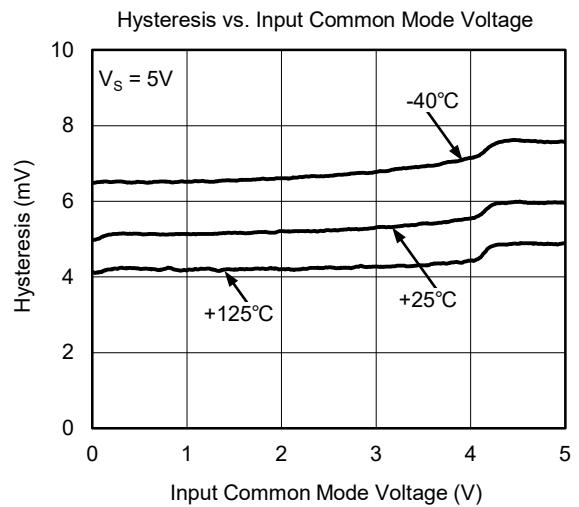
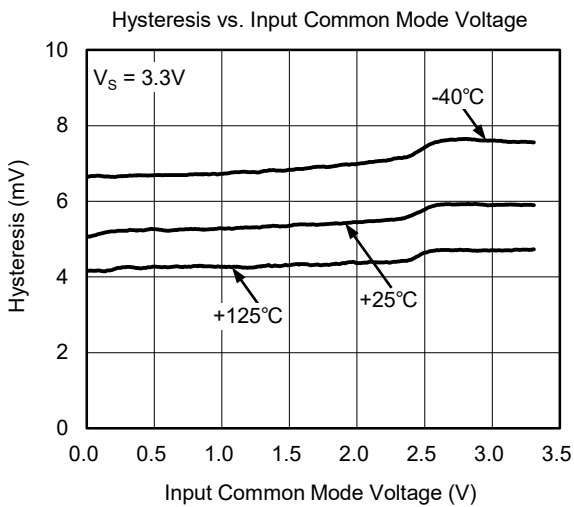
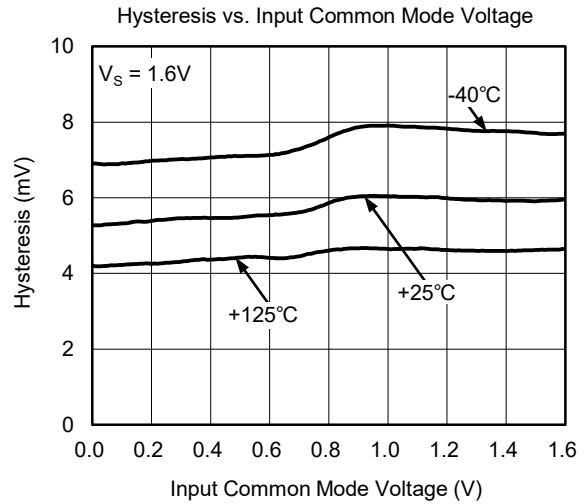
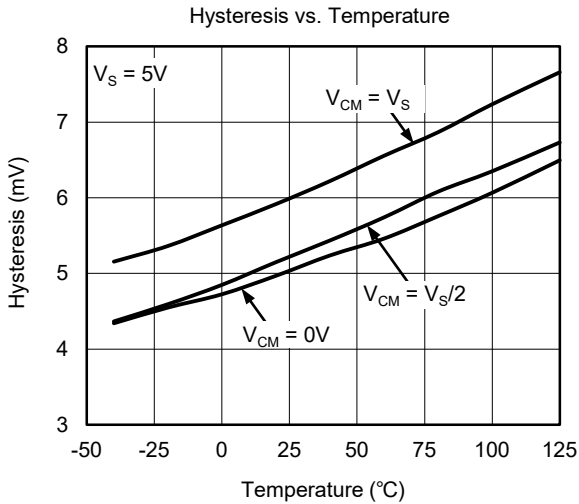
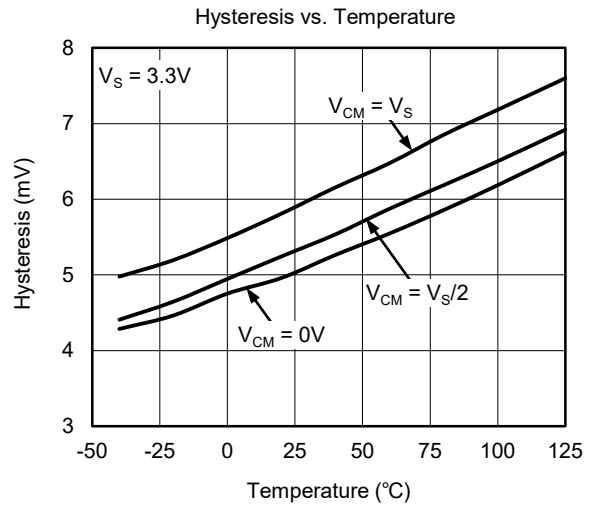
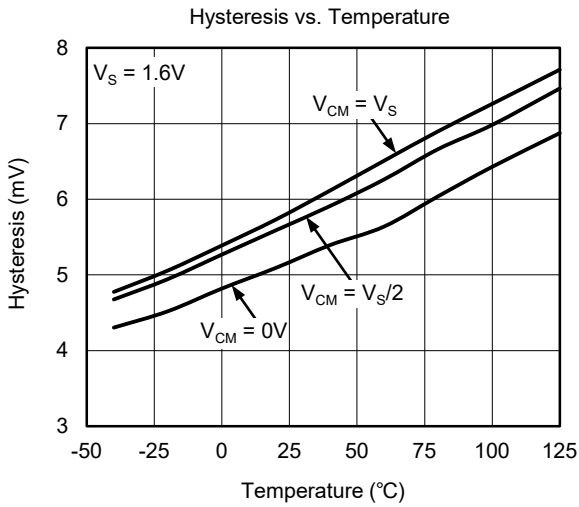

**TYPICAL PERFORMANCE CHARACTERISTICS (continued)**

At  $T_A = +25^\circ\text{C}$ , unless otherwise noted.

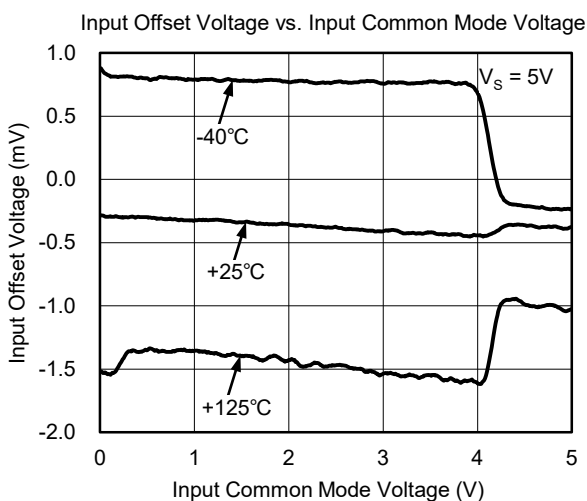
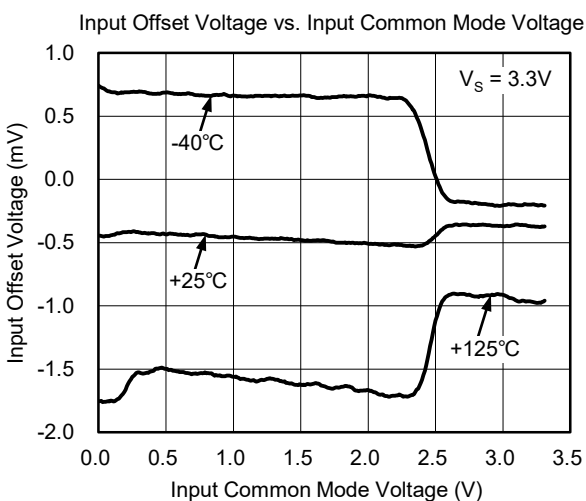
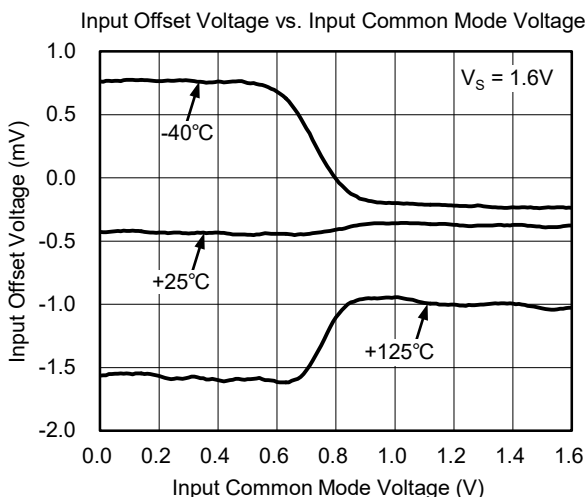
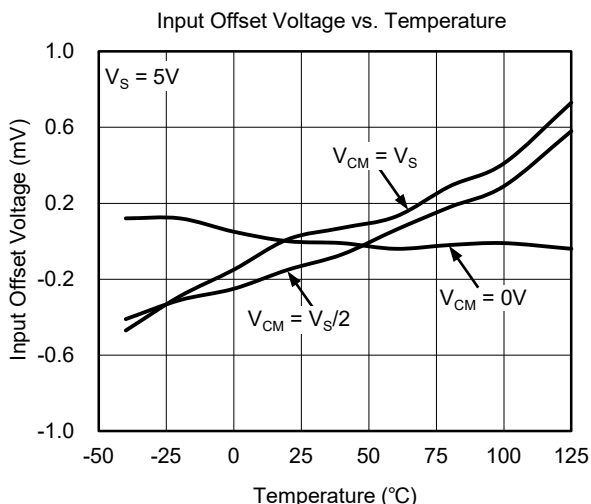
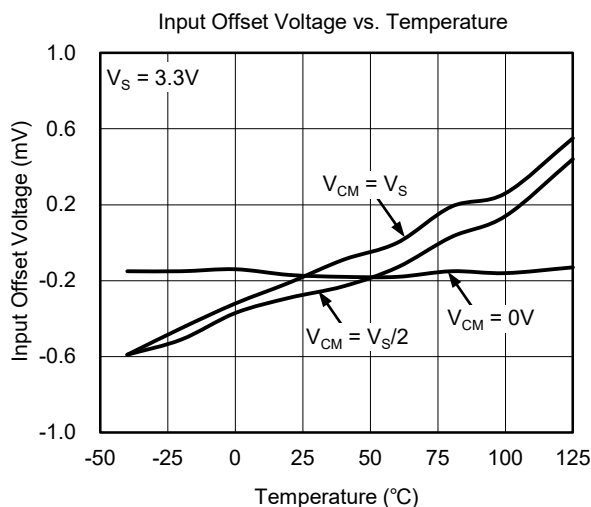
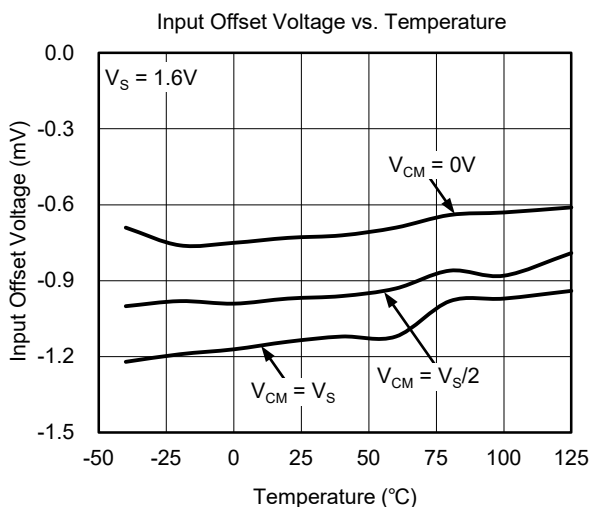

**TYPICAL PERFORMANCE CHARACTERISTICS (continued)**

At  $T_A = +25^\circ\text{C}$ , unless otherwise noted.

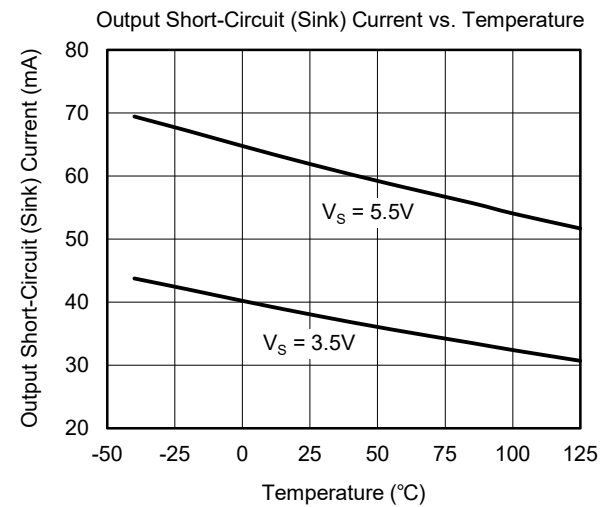
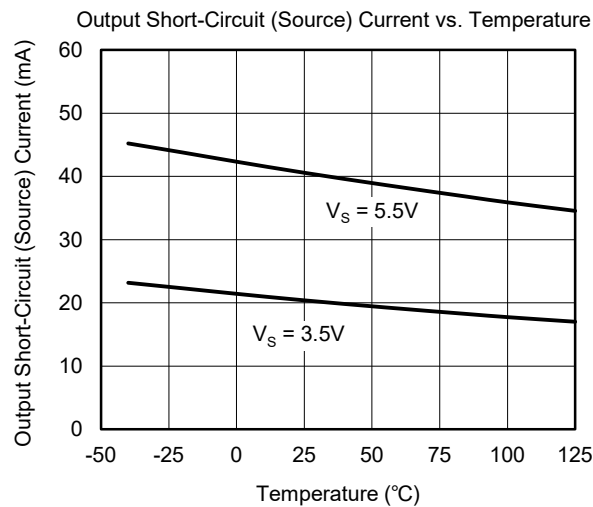
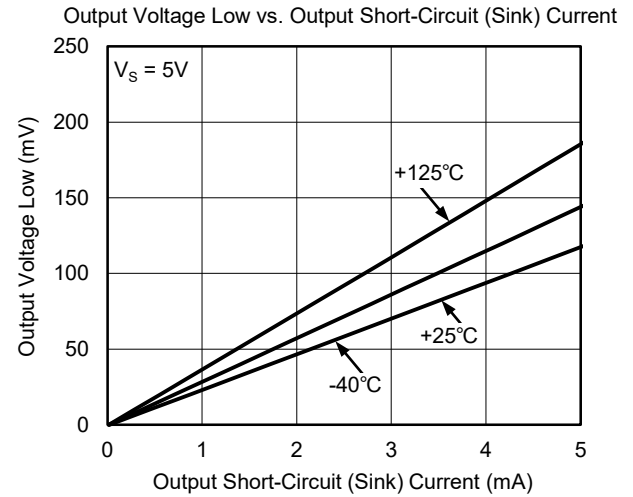
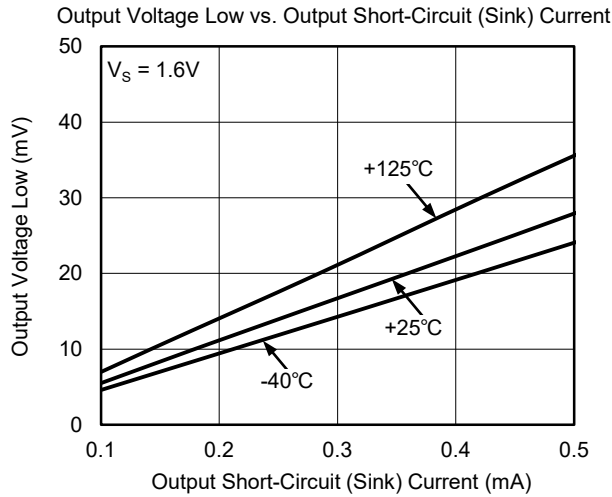
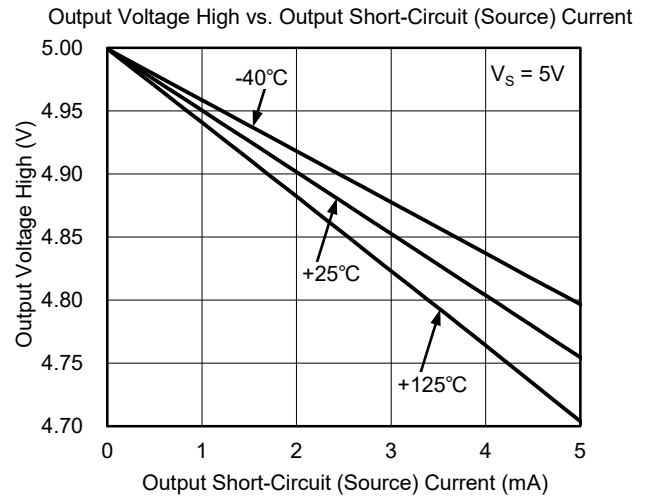
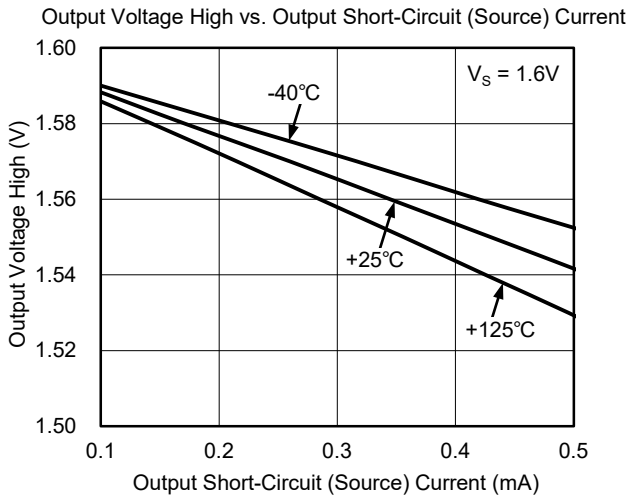

**TYPICAL PERFORMANCE CHARACTERISTICS (continued)**

At  $T_A = +25^\circ\text{C}$ , unless otherwise noted.

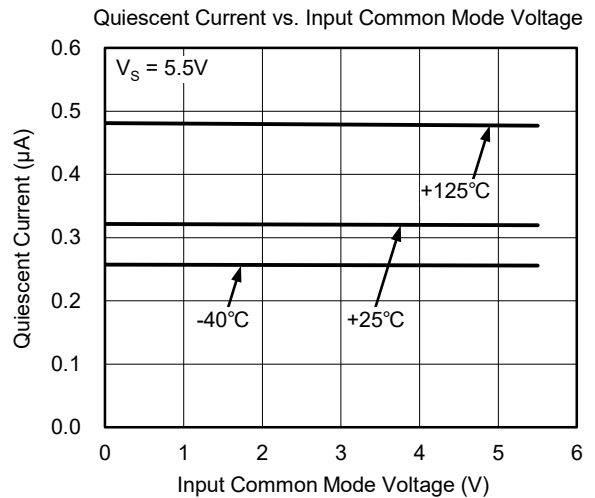
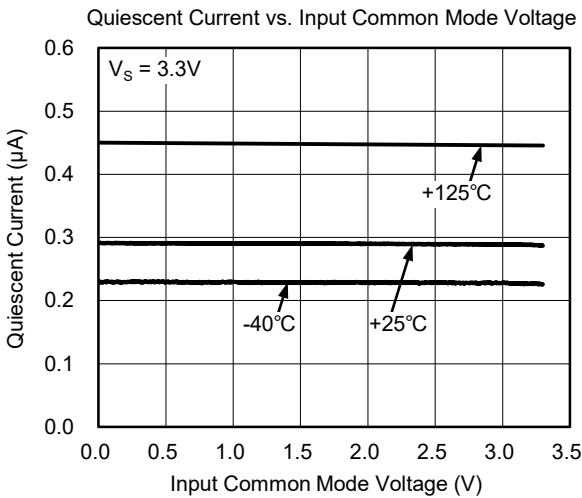
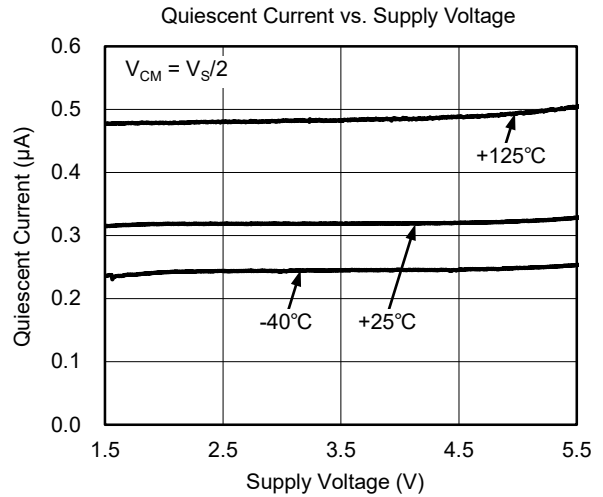
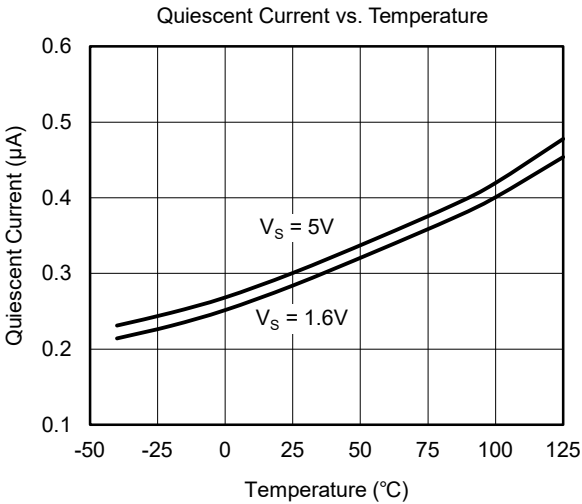
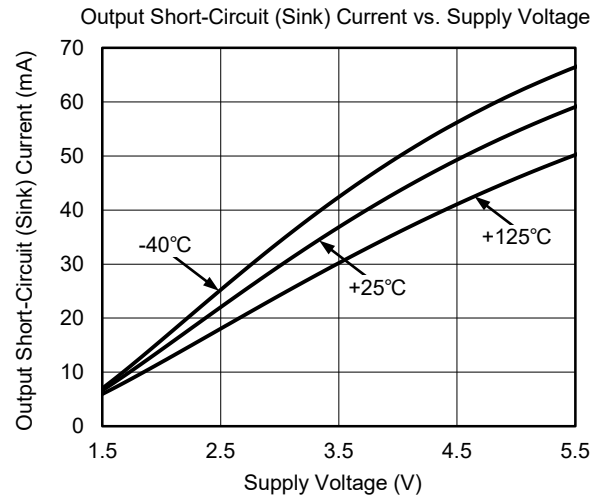
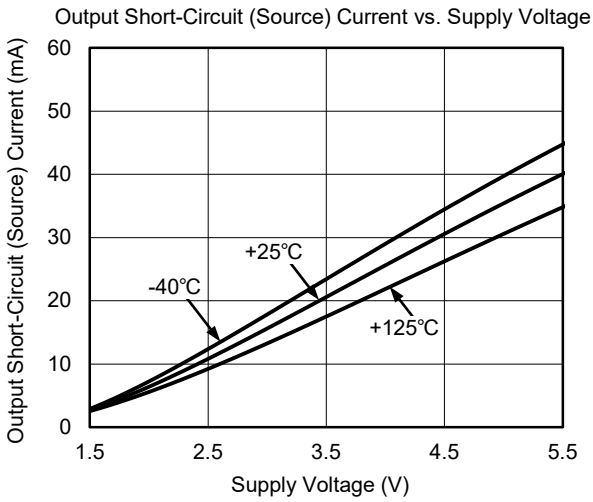

**TYPICAL PERFORMANCE CHARACTERISTICS (continued)**

At  $T_A = +25^\circ\text{C}$ , unless otherwise noted.

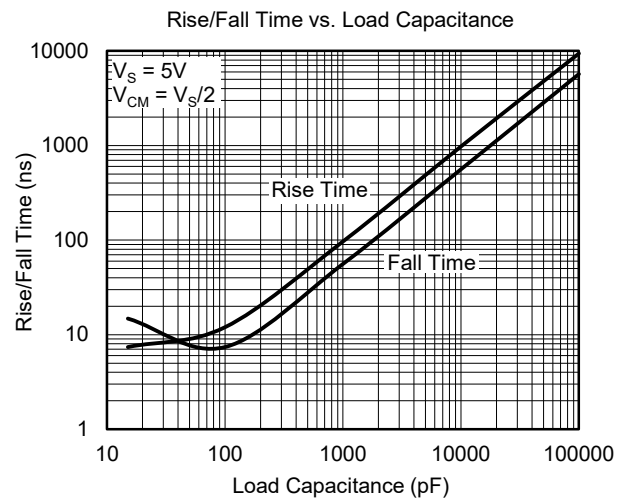
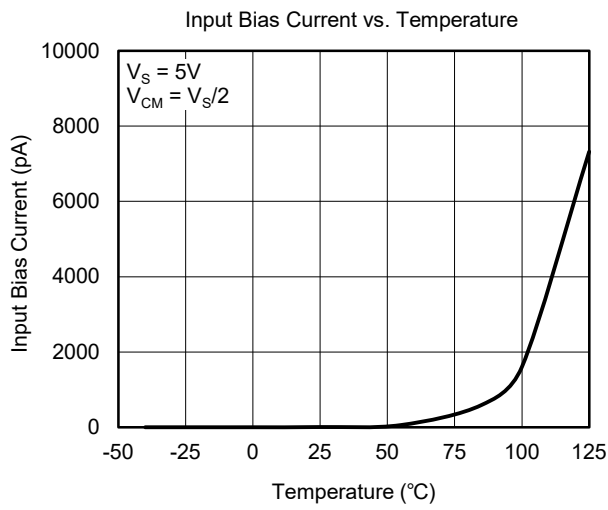

**DETAILED DESCRIPTION**

The SGM8713A-1 and SGM8713B-1 are single, nano-power, rail-to-rail input and small size comparators. They are optimized for low voltage operation from 1.6V to 5.5V single supply, consuming only 300nA quiescent current. The output stage of the comparator is open-drain and push-pull. Both devices are packaged in a space-saving XTDFN package, which makes them good choices for portable devices.

**Device Function**

**Inputs**

The maximum input common mode voltage range of the comparator is from  $-V_S$  to  $V_S$ .

To protect the inputs of the comparator from going out of range, the internal diode connected to  $-V_S$  is taken into account. To explain, the internal diode can be forward biased if the input voltage is below  $-V_S$  and the input bias current of the comparator is increasing exponentially at this situation.

**Output**

To save the PCB space by eliminating the external open-drain resistor, the SGM8713A-1 provides the output stage of push-pull. Also, the SGM8713B-1 provides the output of open-drain for the specific applications.

**Internal Hysteresis**

The hysteresis curve is shown in Figure 2. The following three components are related to the hysteresis of the SGM8713A-1 and SGM8713B-1, which are  $V_{TH}$ ,  $V_{OS}$ , and  $V_{HYST}$ .

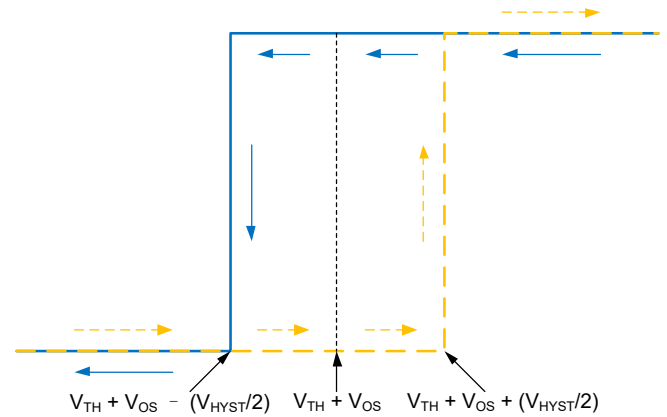

**NOTES:**

- $V_{TH}$  is the trip voltage or set voltage of the comparator.
- $V_{OS}$  is defined as the input offset voltage between  $V_{IN+}$  and  $V_{IN-}$  when  $V_{OUT} = 0V$ . This offset voltage is considered into the influence of the hysteresis which can affect the respond of the output.
- $V_{HYST}$  is used to decrease the sensitivity to the noisy input voltage ( $V_{HYST} = 6mV$  for both SGM8713A-1 and SGM8713B-1).

**Figure 2. Hysteresis Transfer Curve**

**APPLICATION INFORMATION**

The SGM8713A-1 and SGM8713B-1 are single, nano-power, rail to rail input and small size comparators. The above advantages make these comparators operated well in the battery-powered system. Also, the input rail-to-rail hysteresis can manage the input signal which is higher than the positive power supply with the internal hysteresis. The positive feedback should be taken into account for the applications of higher hysteresis. The power-budget can be reduced by the structure of push-pull for SGM8713A-1. The ability of open-drain for SGM8713B-1 is suitable for the condition of level shifting or wire-ORing.

**Inverting Comparator with Hysteresis for SGM8713A-1**

Figure 3 illustrates how SGM8713A-1 works with the external hysteresis. If the level of  $V_{IN}$  is lower than  $V_{A1}$ , the  $V_{OUT}$  is in high position and it can be seen that  $V_{OUT} = V_S$ . For the special distribution of the feedback resistors, it can be seen as  $R_1//R_2$  in series with  $R_3$ . The

threshold ( $V_{A1}$ ) of high-to-low transition is shown in Equation 1.

$$V_{A1} = V_S \times \frac{R_3}{(R_1 \parallel R_2) + R_3} \tag{1}$$

After  $V_{IN}$  reaches the level of  $V_{A1}$  and still increases, the level of  $V_{OUT}$  is in low position. For this situation, as the output voltage at this case is closed to GND, the feedback resistance network can be seen as  $R_1$  in series with  $R_2//R_3$ . The threshold ( $V_{A2}$ ) of low-to-high transition is shown in Equation 2.

$$V_{A2} = V_S \times \frac{R_2 \parallel R_3}{R_1 + (R_2 \parallel R_3)} \tag{2}$$

The hysteresis caused by the circuit is shown in Equation 3.

$$\Delta V_A = V_{A1} - V_{A2} \tag{3}$$

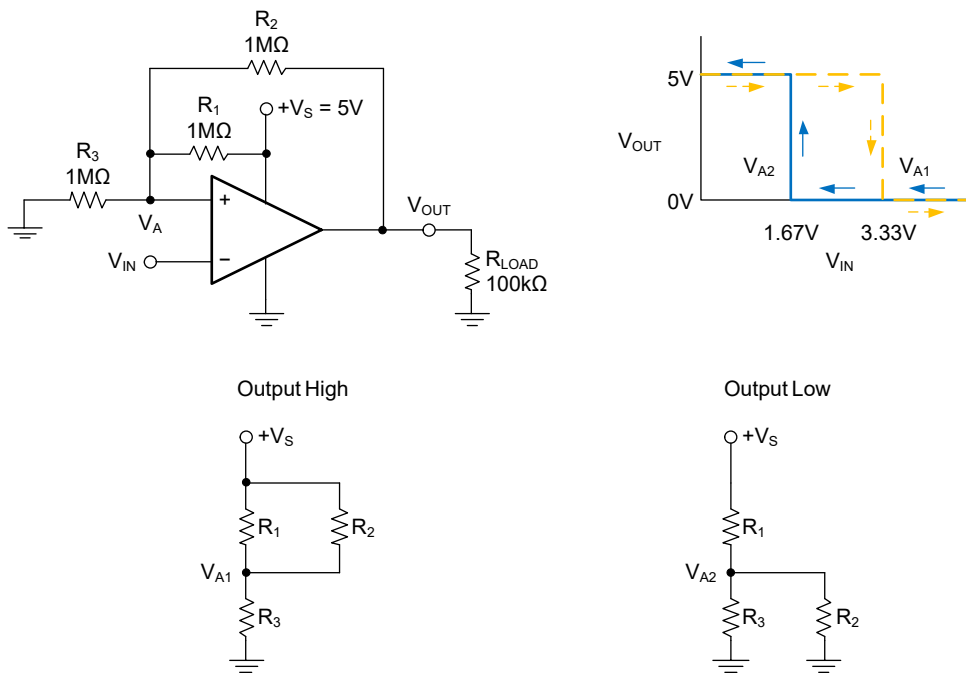

**Figure 3. SGM8713A-1 in an Inverting Configuration with Hysteresis**

**APPLICATION INFORMATION (continued)**

**Non-Inverting Comparator with Hysteresis for SGM8713A-1**

Figure 4 illustrates the non-inverting circuit with external hysteresis. To explain, the output remains in low position when the input of the circuit is below the threshold  $V_{IN1}$ . However, the output of the circuit will change to high position if the input voltage is larger than  $V_{IN1}$ . The value of  $V_{IN1}$  is shown as below:

$$V_{IN1} = R_1 \times \frac{V_{REF}}{R_2} + V_{REF} \tag{4}$$

As the increasing of  $V_{IN}$ , the output remains at high position. Moreover, if  $V_{IN}$  is lower than  $V_{IN2}$ , the output will go back to low state again. The value of  $V_{IN2}$  is shown as below:

$$V_{IN2} = \frac{V_{REF} \times (R_1 + R_2) - V_S \times R_1}{R_2} \tag{5}$$

The hysteresis caused by the non-inverting circuit is shown in Equation 6.

$$\Delta V_{IN} = V_S \times \frac{R_1}{R_2} \tag{6}$$

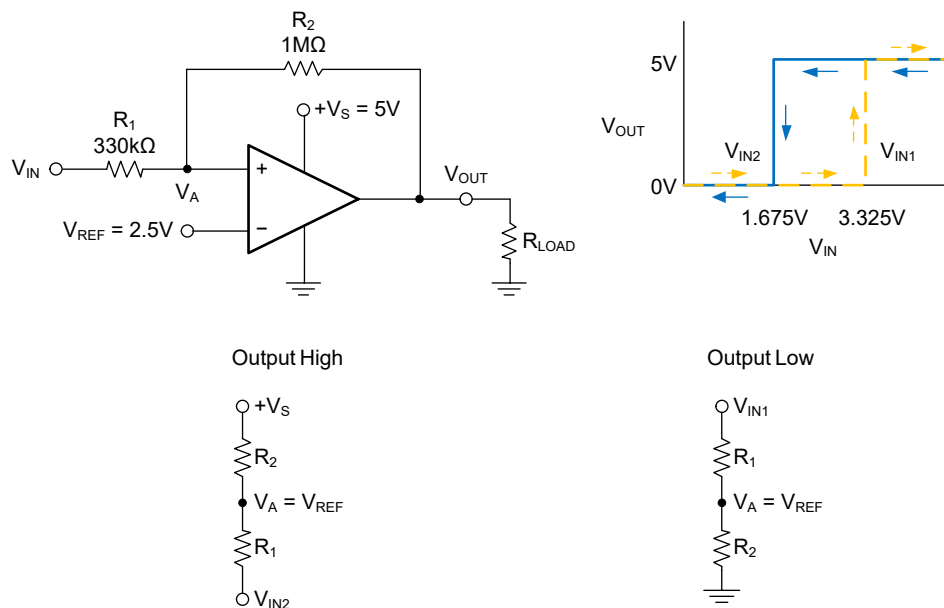
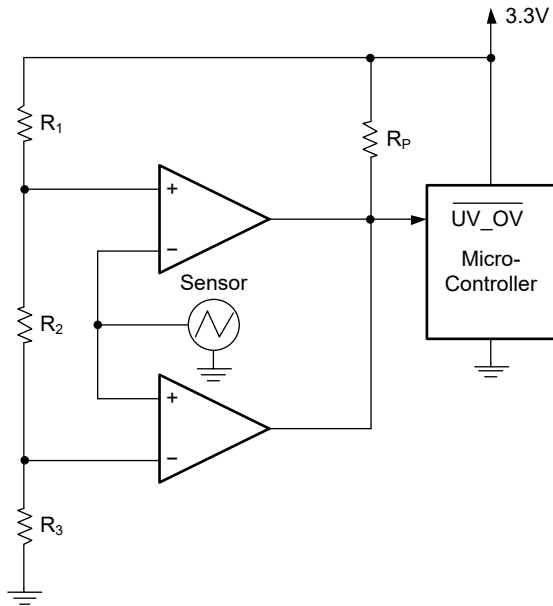

**Figure 4. SGM8713A-1 in a Non-Inverting Configuration with Hysteresis**

**APPLICATION INFORMATION (continued)**

**Window Comparator**

The application of window comparator of SGM8713B-1 is shown in Figure 5, and it is used for detecting the under-voltage or over-voltage situation.



**Figure 5. SGM8713B-1 Based Window Comparator**

**Design Requirements**

The parameters of the above circuit are illustrated:

- ◆ The alert of logic low will be triggered if  $V_{IN}$  is lower than 1.1V.
- ◆ The alert of logic low will be triggered if  $V_{IN}$  is lower than 2.2V.
- ◆ The alert happens when the output of the circuit is low.
- ◆ Powered by 3.3V DC voltage.

**Detailed Design Procedure**

For the detail of SGM8713B-1, the pins of  $+V_S$  and  $-V_S$  are connected to +3.3V and GND respectively. Set the value of  $R_1$ ,  $R_2$  and  $R_3$  equals to 10M $\Omega$  so that the two thresholds of the circuit are equals to +1.1V and +2.2V respectively. The reason for using large resistors is that the power consumption can be reduced dramatically. From the circuit in Figure 5, the output of the sensor is connected to the non-inverting and inverting inputs of the circuit respectively. The open-drain configuration of the outputs is used, and the two outputs are wire-ORed. If the level of input signal is lower than 1.1V or higher than 2.2V, the output of the circuit is in low state. Also, the output voltage remains high if the input voltage is within the range of 1.1V and 2.2V.

**Application Curve**

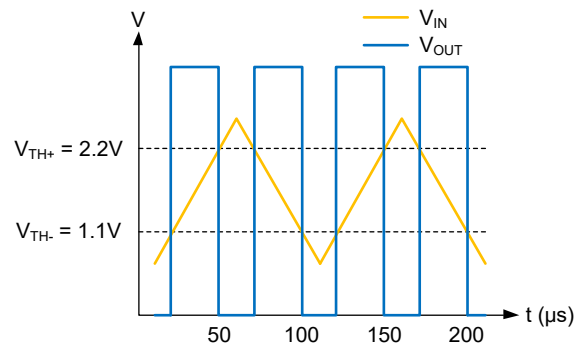
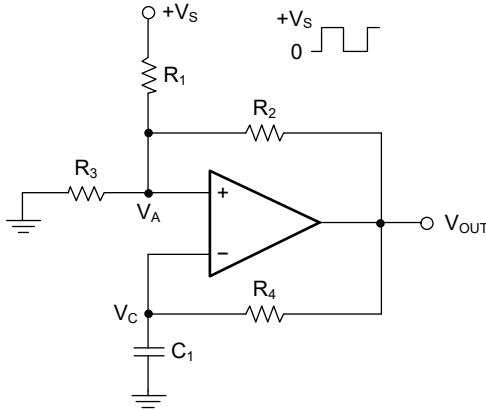

**Figure 6. Window Comparator Results**

**APPLICATION INFORMATION (continued)**

**Square-Wave Oscillator**

The following circuit is widely used for the applications of low-cost timing reference or clock source of the system.



**Figure 7. Square-Wave Oscillator**

**Design Requirements**

For the circuit in Figure 7, the period of the square wave is determined by the time constant  $R_4C_1$ . There are two parameters that limit the frequency of the square wave, which are the propagation delay of the comparator and the capacitance of the load. For a specific oscillation frequency, the feedback resistor  $R_4$  can be larger when considering using small capacitor as the extreme low bias current of the input.

**Detailed Design Procedure**

The time constant  $R_4C_1$  determines the oscillated frequency of the circuit.

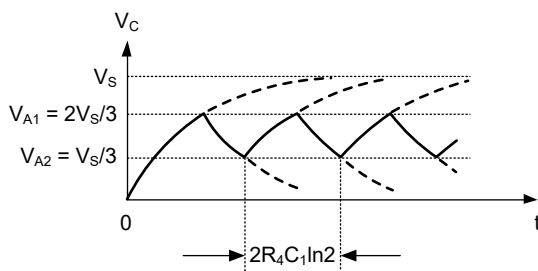

**Figure 8. Square-Wave Oscillator Timing and Thresholds**

To explain the operation of the circuit, first, it can be assumed that  $V_{OUT}$  is in high position. Then, the capacitor  $C_1$  is charged by  $V_{OUT}$  at this stage until the value of  $V_C$  reaches the value of  $V_{A1}$ . The following equation illustrates the threshold  $V_{A1}$  for the above case:

$$V_{A1} = \frac{V_S \times R_3}{R_3 + R_1 \parallel R_2}$$

$$V_{A1} = V_S \times \frac{R_2}{(R_1 \parallel R_3) + R_2} \tag{7}$$

If  $R_1 = R_2 = R_3$ , then  $V_{A1} = 2V_S/3$ .

Once the value of  $V_C > V_{A1}$ , the output of the comparator will be in low position (GND). The following equation illustrates the threshold  $V_{A2}$ :

$$V_{A2} = \frac{V_S \times (R_2 \parallel R_3)}{R_1 + R_2 \parallel R_3} \tag{8}$$

If  $R_1 = R_2 = R_3$ , then  $V_{A2} = V_S/3$ .

Once  $V_A < V_C$ , the capacitor  $C_1$  will discharge until the value of  $V_C$  reaches the threshold  $V_{A2}$ . As the decreasing of  $V_C$ , the output will switch back to high position again. To calculate the time period of oscillation, it is considered as the value of  $V_C$  changes from  $2V_S/3$  to  $V_S/3$ , and then goes back to  $2V_S/3$  again, and the result equals to  $2R_4C_1 \ln 2$ . To calculate the frequency of oscillation, the equation is shown as below:

$$f = 1 / (2 \times R_4 \times C_1 \times \ln 2) \tag{9}$$

**APPLICATION INFORMATION (continued)**

**Power Supply**

In general, a single power supply ranged from 1.6V to 5.5V is recommended, the output of comparator is high ( $V_{OUT} = V_S$ ) or low ( $V_{OUT} = GND$ ). Sometimes, bipolar power supply is also used by SGM8713A-1 and SGM8713B-1 in level shifting application, for example, bipolar supply voltages of 2.5V and -2.5V are used for power comparators. If the bipolar mode of the comparator is taken into account, the logic high is  $V_S$  and logic low is  $-V_S$  for this situation.

**Power Supply Decoupling**

It is recommended that the value of chosen bypass capacitor is equal to 100nF to improve the performance of the SGM8713A-1 and SGM8713B-1 for the situations of long trace, noisy and high output impedance of the power supply. Also, if the output of the comparator needs to drive capacitive load and long trace, the bypass capacitor is recommended as well. Because of the high ability of sinking or sourcing output current and high rise or fall edge rate at the output of the comparator, a decoupling capacitor connected to the power supply pin is necessary as the high demand of the current.

**REVISION HISTORY**

NOTE: Page numbers for previous revisions may differ from page numbers in the current version.

| <b>AUGUST 2023 – REV.A.3 to REV.A.4</b>                   | <b>Page</b> |
|---|-------------|
| Updated General Description section.....                  | 1           |
| <hr/>   |             |
| <b>OCTOBER 2022 – REV.A.2 to REV.A.3</b>                  | <b>Page</b> |
| Updated Package Outline Dimensions section .....          | 17          |
| <hr/>   |             |
| <b>OCTOBER 2021 – REV.A.1 to REV.A.2</b>                  | <b>Page</b> |
| Updated Package Outline Dimensions section .....          | 17          |
| <hr/>   |             |
| <b>AUGUST 2021 – REV.A to REV.A.1</b>                     | <b>Page</b> |
| Updated Absolute Maximum Ratings section.....             | 2           |
| Updated Electrical Characteristics section .....          | 4           |
| Updated Typical Performance Characteristics section ..... | 11          |
| Updated Package Outline Dimensions section .....          | 18          |
| <hr/>   |             |
| <b>Changes from Original (NOVEMBER 2020) to REV.A</b>     | <b>Page</b> |
| Changed from product preview to production data.....      | All         |

PACKAGE OUTLINE DIMENSIONS

XTDFN-0.8×0.8-4L

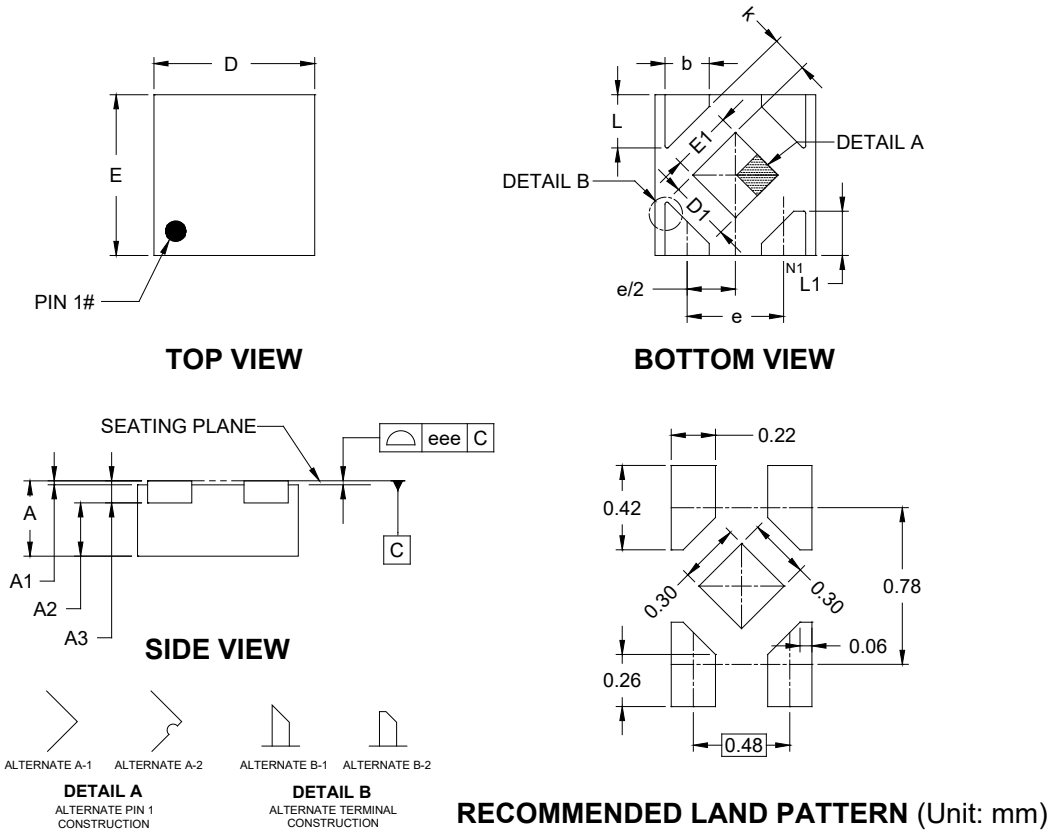

RECOMMENDED LAND PATTERN (Unit: mm)

| Symbol | Dimensions In Millimeters |       |       |
|--------|---------------------------|-------|-------|
|        | MIN                       | NOM   | MAX   |
| A      | 0.320                     | 0.375 | 0.430 |
| A1     | 0.000                     | -     | 0.050 |
| A2     | -                         | 0.265 | -     |
| A3     | 0.110 REF                 |       |       |
| b      | 0.150                     | 0.220 | 0.290 |
| D      | 0.700                     | 0.800 | 0.900 |
| E      | 0.700                     | 0.800 | 0.900 |
| D1     | 0.200                     | 0.300 | 0.400 |
| E1     | 0.200                     | 0.300 | 0.400 |
| L      | 0.150                     | 0.265 | 0.320 |
| L1     | 0.150                     | 0.220 | 0.270 |
| e      | 0.480 BSC                 |       |       |
| k      | 0.150 MIN                 |       |       |
| eee    | 0.050                     |       |       |

NOTE: This drawing is subject to change without notice.

**TAPE AND REEL INFORMATION**

**REEL DIMENSIONS**

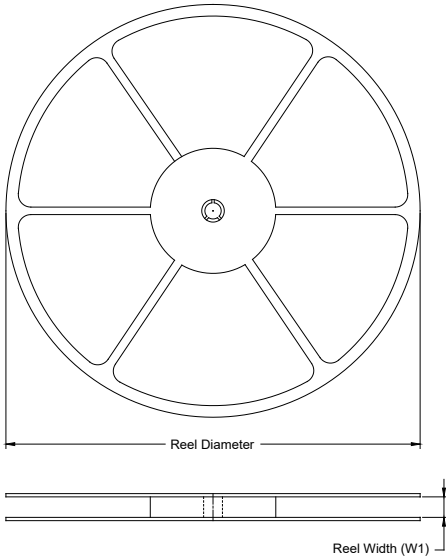

**TAPE DIMENSIONS**

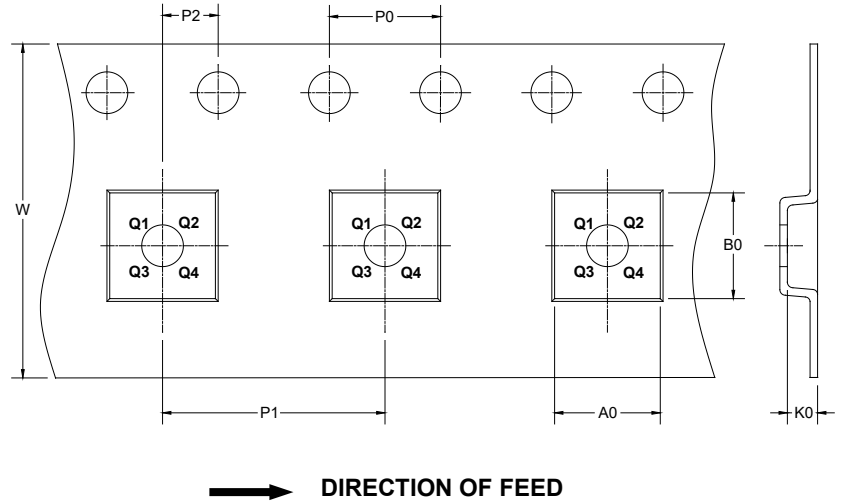

NOTE: The picture is only for reference. Please make the object as the standard.

**KEY PARAMETER LIST OF TAPE AND REEL**

| Package Type     | Reel Diameter | Reel Width W1 (mm) | A0 (mm) | B0 (mm) | K0 (mm) | P0 (mm) | P1 (mm) | P2 (mm) | W (mm) | Pin1 Quadrant |
|------------------|---------------|--------------------|---------|---------|---------|---------|---------|---------|--------|---------------|
| XTDFN-0.8×0.8-4L | 7"            | 9.5                | 0.94    | 0.94    | 0.50    | 4.0     | 2.0     | 2.0     | 8.0    | Q1            |

DD0001

# PACKAGE INFORMATION

## CARTON BOX DIMENSIONS

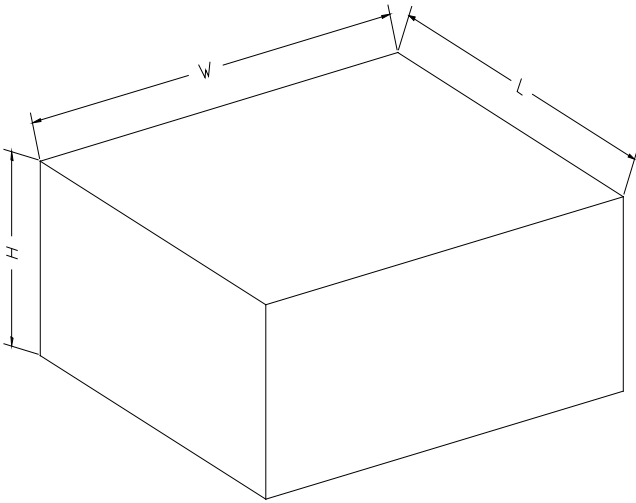

NOTE: The picture is only for reference. Please make the object as the standard.

## KEY PARAMETER LIST OF CARTON BOX

| Reel Type   | Length (mm) | Width (mm) | Height (mm) | Pizza/Carton |
|-------------|-------------|------------|-------------|--------------|
| 7" (Option) | 368         | 227        | 224         | 8            |
| 7"          | 442         | 410        | 224         | 18           |

D00002