

LM358

Dual Operational Amplifier

GENERAL DESCRIPTION

The LM358 consists of two independent, high-gain frequency-compensated operational amplifiers designed to operate from a single supply or dual supplies over a wide range of voltages.

The LM358 is available in Green SOIC-8 and MSOP-8 packages. It is specified over the 0°C to +70°C temperature range.

APPLICATIONS

Blu-ray Players and Home Theaters
Chemical and Gas Sensors
DVD Recorders and Players
Digital Multimeter: Bench and Systems
Digital Multimeter: Handhelds
Field Transmitter: Temperature Sensors
Motor Control: AC Induction, Brushed DC, Brushless DC, High-Voltage, Low-Voltage, Permanent Magnet, and Stepper Motors
Oscilloscopes
TV: LCD and Digital
Temperature Sensors or Controllers Using Modbus
Weigh Scales

FEATURES

- **Wide Supply Ranges**
 - **Single Supply: 3V to 32V**
 - **Dual Supplies: $\pm 1.5V$ to $\pm 16V$**
- **Low Quiescent Current: 440 μ A (TYP)**
- **Gain-Bandwidth Product: 1.1MHz**
- **Input Common Mode Voltage Range Includes Ground, Allowing Direct Sensing Near Ground**
- **Low Input Offset Voltage: 5.8mV (MAX)**
- **Low Input Offset Current: 20pA (TYP)**
- **Low Input Bias Current: 10pA (TYP)**
- **Differential Input Voltage Range Equal to Maximum-Rated Supply Voltage: 32V**
- **Open-Loop Differential Voltage Gain: 111dB (TYP)**
- **Internal Frequency Compensation**
- **0°C to +70°C Operating Temperature Range**
- **Available in Green SOIC-8 and MSOP-8 Packages**

PACKAGE/ORDERING INFORMATION

MODEL	PACKAGE DESCRIPTION	SPECIFIED TEMPERATURE RANGE	ORDERING NUMBER	PACKAGE MARKING	PACKING OPTION
LM358	SOIC-8	0°C to +70°C	LM358ZS8G/TR	LM 358ZS8 XXXXX	Tape and Reel, 4000
	MSOP-8	0°C to +70°C	LM358ZMS8G/TR	LM358 ZMS8 XXXXX	Tape and Reel, 4000

MARKING INFORMATION

NOTE: XXXXX = Date Code, Trace Code and Vendor Code.

XXXXX

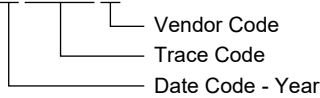

Green (RoHS & HSF): SG Micro Corp defines "Green" to mean Pb-Free (RoHS compatible) and free of halogen substances. If you have additional comments or questions, please contact your SGMICRO representative directly.

ABSOLUTE MAXIMUM RATINGS

Supply Voltage, V_s ⁽¹⁾	-0.3V to 32V
Differential Input Voltage, V_{ID} ⁽²⁾	-32V to 32V
Input Voltage (Either Input)	-0.3V to 32V
Junction Temperature	+150°C
Storage Temperature Range	-65°C to +150°C
Lead Temperature (Soldering, 10s)	+260°C
ESD Susceptibility	
HBM	6000V
CDM	1000V

RECOMMENDED OPERATING CONDITIONS

Input Common Mode Voltage Range	-0.1V to $V_s - 1.5V$
Operating Temperature Range	0°C to +70°C

NOTES:

- All voltage values (except differential voltages and V_s specified for the measurement of I_{sc}) are with respect to the network GND.
- Differential voltages are at +IN, with respect to -IN.

OVERSTRESS CAUTION

Stresses beyond those listed in Absolute Maximum Ratings may cause permanent damage to the device. Exposure to absolute maximum rating conditions for extended periods may affect reliability. Functional operation of the device at any conditions beyond those indicated in the Recommended Operating Conditions section is not implied.

ESD SENSITIVITY CAUTION

This integrated circuit can be damaged by ESD if you don't pay attention to ESD protection. SGMICRO recommends that all integrated circuits be handled with appropriate precautions. Failure to observe proper handling and installation procedures can cause damage. ESD damage can range from subtle performance degradation to complete device failure. Precision integrated circuits may be more susceptible to damage because very small parametric changes could cause the device not to meet its published specifications.

DISCLAIMER

SG Micro Corp reserves the right to make any change in circuit design, or specifications without prior notice.

PIN CONFIGURATION

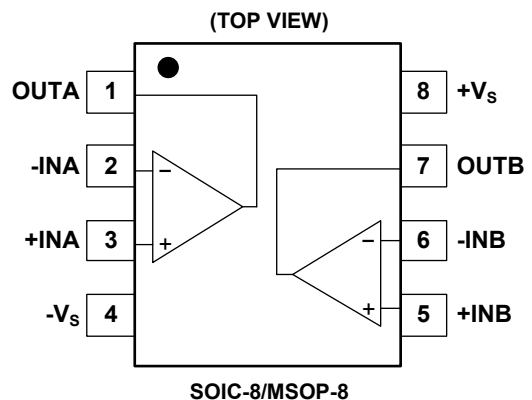

ELECTRICAL CHARACTERISTICS

(At $T_A = +25^\circ\text{C}$, $V_S = 3\text{V}$ to 32V , $R_L = 10\text{k}\Omega$ connected to $V_S/2$, $-0.1\text{V} < V_{CM} < V_S - 1.5\text{V}$, Full = 0°C to $+70^\circ\text{C}$, unless otherwise noted.)

PARAMETER	SYMBOL	CONDITIONS	TEMP	MIN	TYP	MAX	UNITS
Input Characteristics							
Input Offset Voltage	V_{OS}		+25°C		1.2	5.8	mV
			Full			6.6	
Input Bias Current	I_B	$V_{CM} = V_S/2$	+25°C		10		pA
Input Offset Current	I_{OS}	$V_{CM} = V_S/2$	+25°C		20		pA
Maximum Differential Input Voltage	$ V_{ID} $		Full			V_S	V
Input Common Mode Voltage Range	V_{CM}		Full	-0.1		$V_S - 1.5$	V
Common Mode Rejection Ratio	CMRR	$-0.1\text{V} < V_{CM} < V_S - 1.5\text{V}$	+25°C	82	118		dB
			Full	80			
Open-Loop Voltage Gain	A_{OL}	$R_L = 10\text{k}\Omega$ to $V_S/2$	+25°C	92	111		dB
			Full	90			
Output Characteristics							
High-Level Output Voltage	V_{OH}	$R_L = 10\text{k}\Omega$	+25°C		42	60	mV
			Full			70	
Low-Level Output Voltage	V_{OL}	$R_L = 10\text{k}\Omega$	+25°C		110	190	mV
			Full			210	
Output Short-Circuit Current	I_{SC}		+25°C	12	18		mA
Power Supply							
Operating Voltage Range	V_S		Full	3		32	V
Quiescent Current	I_Q	$I_{OUT} = 0$	+25°C		440	680	μA
			Full			800	
Power Supply Rejection Ratio	PSRR		+25°C	102	122		dB
			Full	100			
Turn-On Time		$G = +1$	+25°C		42		μs
Dynamic Performance ($C_{LOAD} = 100\text{pF}$)							
Gain-Bandwidth Product	GBP		+25°C		1.1		MHz
Slew Rate	SR	$G = +1$	+25°C		0.35		$\text{V}/\mu\text{s}$
Overload Recovery Time	ORT	$V_{IN} \times G > V_S$	+25°C		2.3		μs
Phase Margin			+25°C		60		°
Noise							
Input Voltage Noise		$f = 0.1\text{Hz}$ to 10Hz	+25°C		8.7		μV_{P-P}
Input Voltage Noise Density	e_n	$f = 1\text{kHz}$	+25°C		36		$\text{nV}/\sqrt{\text{Hz}}$

TYPICAL PERFORMANCE CHARACTERISTICS

At $T_A = +25^\circ\text{C}$, $V_{CM} = V_S/2$, unless otherwise noted.

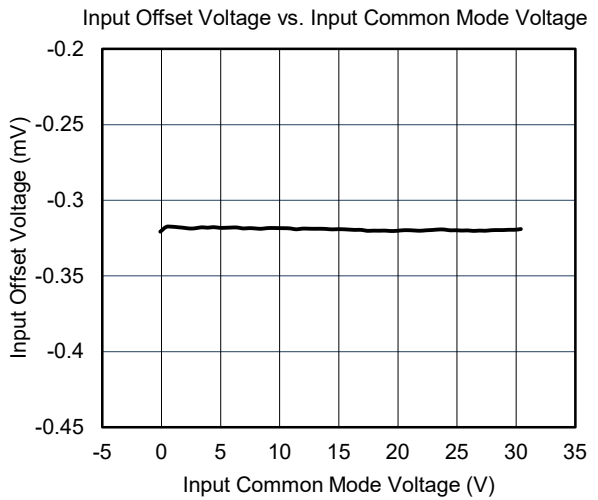
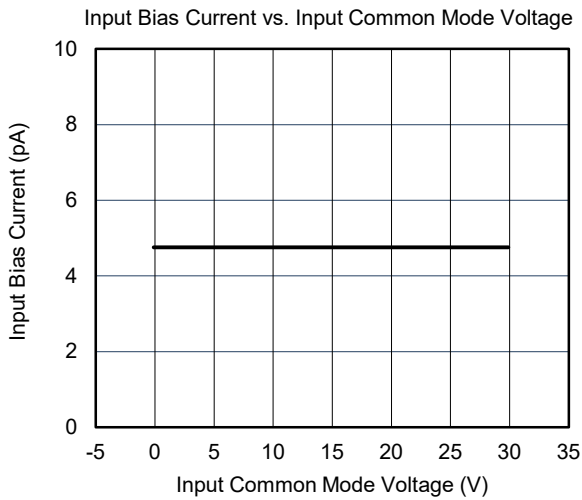
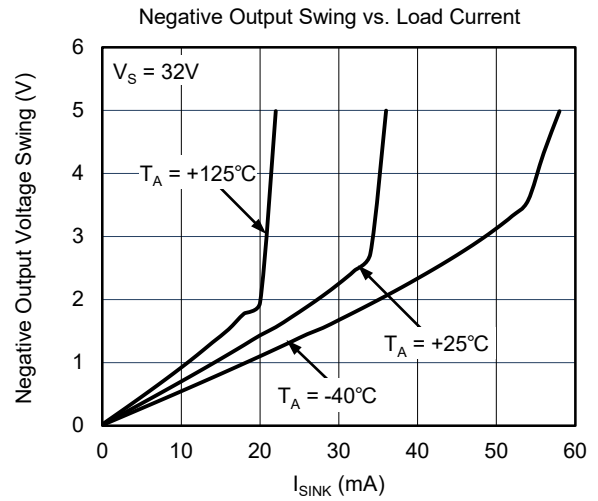
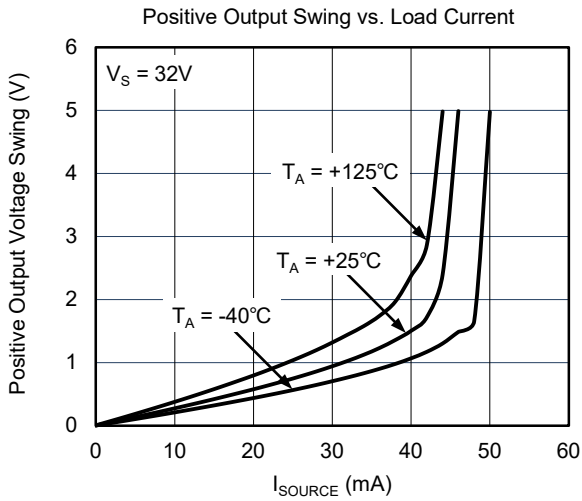
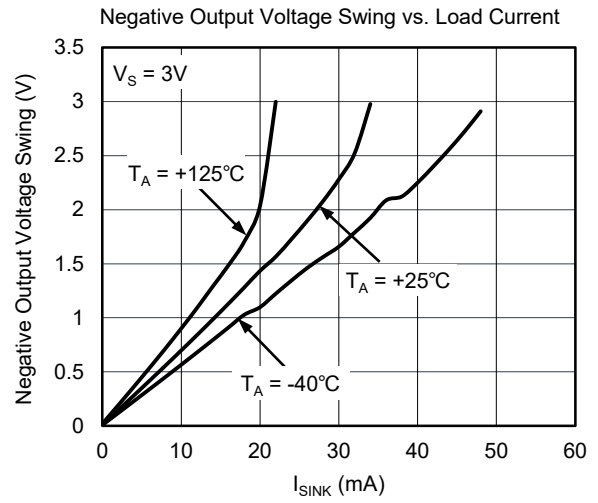
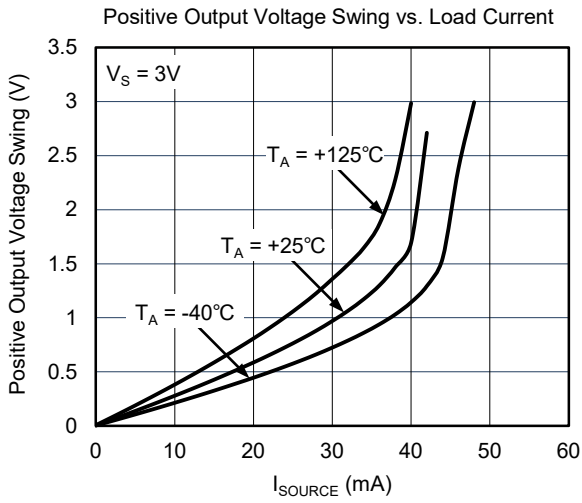

TYPICAL PERFORMANCE CHARACTERISTICS (continued)

At $T_A = +25^\circ\text{C}$, $V_{CM} = V_S/2$, unless otherwise noted.

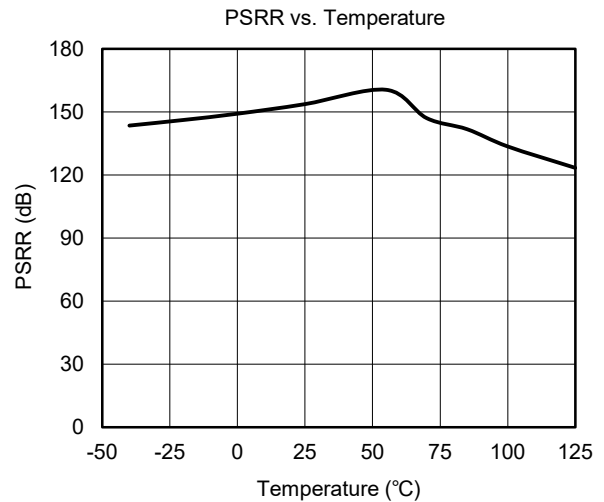
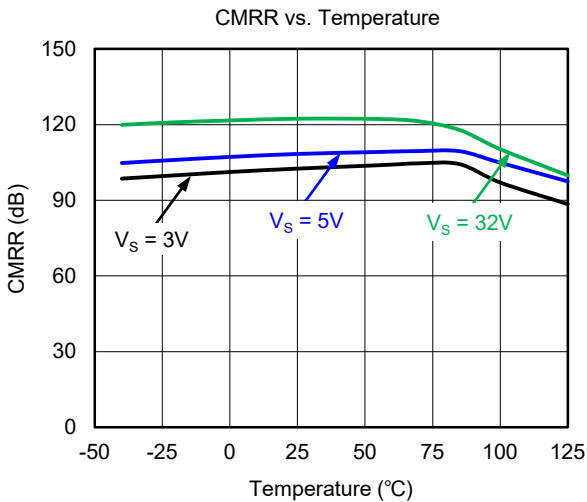
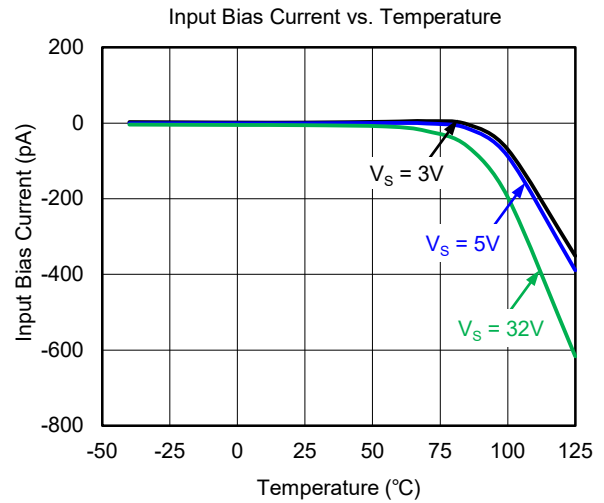
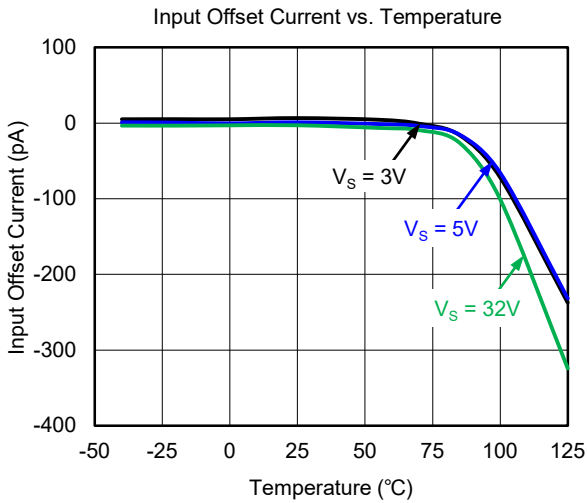
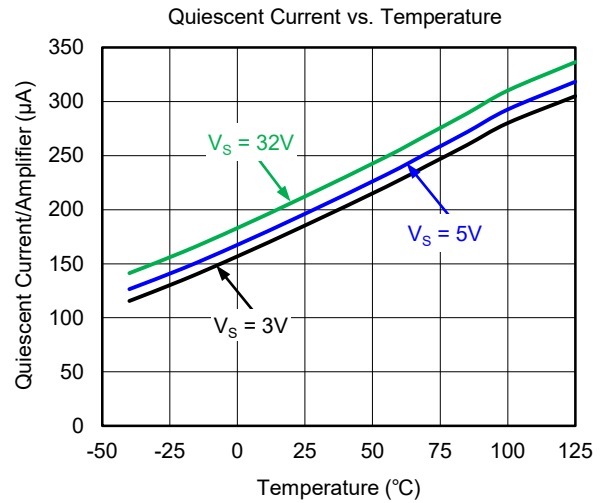
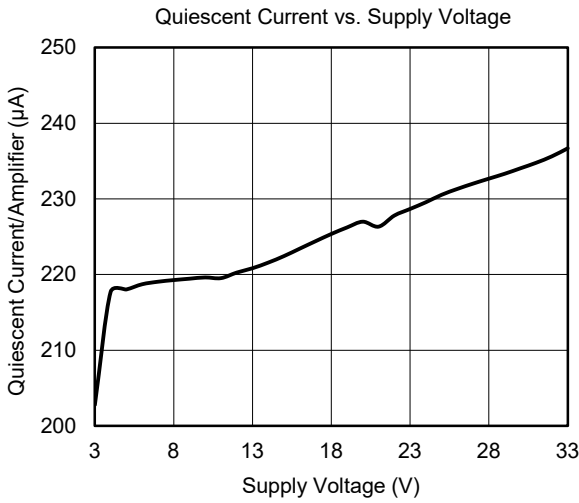

TYPICAL PERFORMANCE CHARACTERISTICS (continued)

At $T_A = +25^\circ\text{C}$, $V_{CM} = V_S/2$, unless otherwise noted.

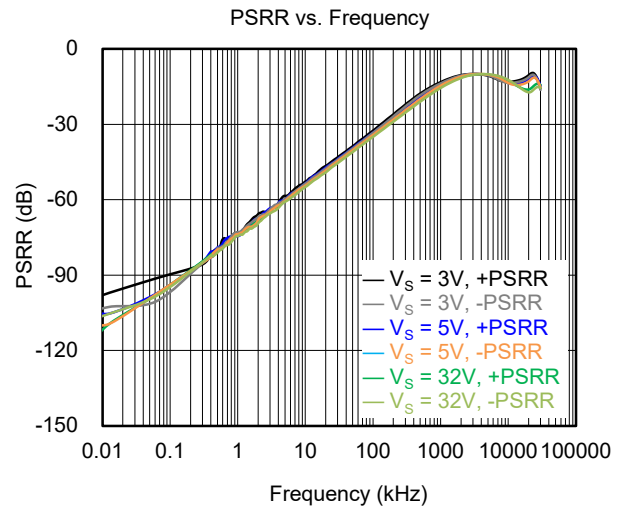
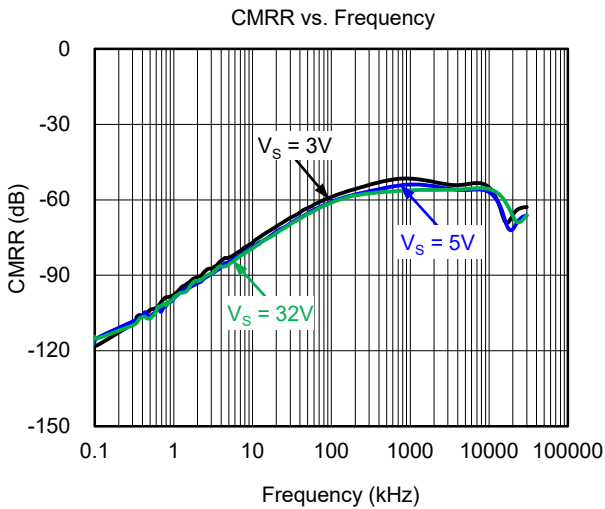
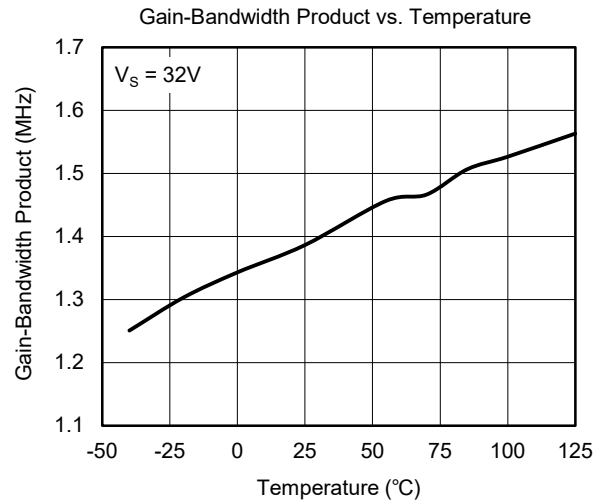
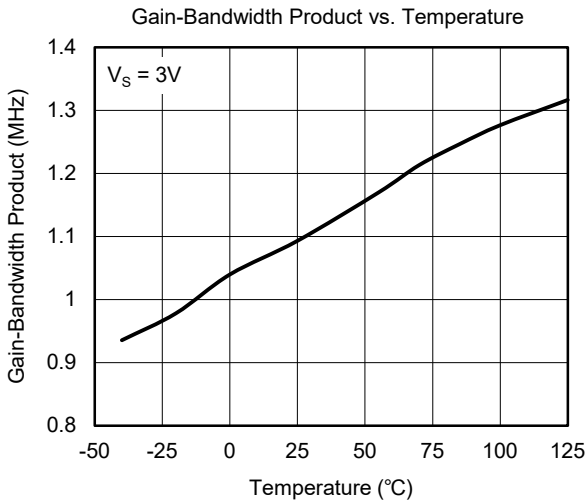
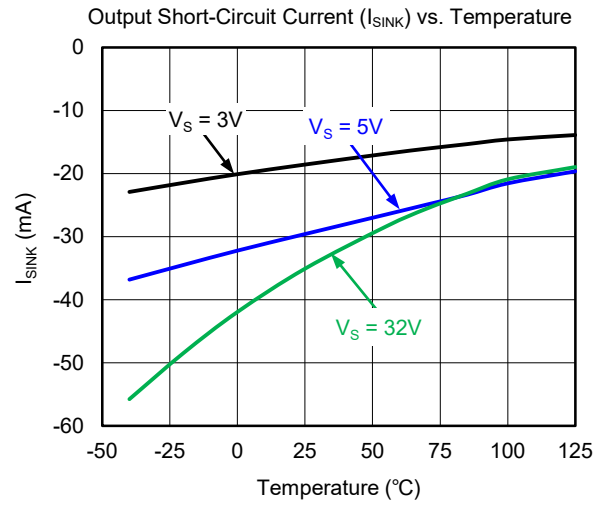
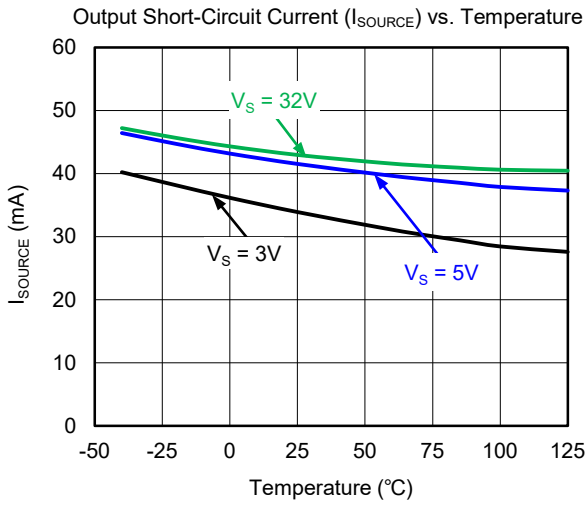

TYPICAL PERFORMANCE CHARACTERISTICS (continued)

At $T_A = +25^\circ\text{C}$, $V_{CM} = V_S/2$, unless otherwise noted.

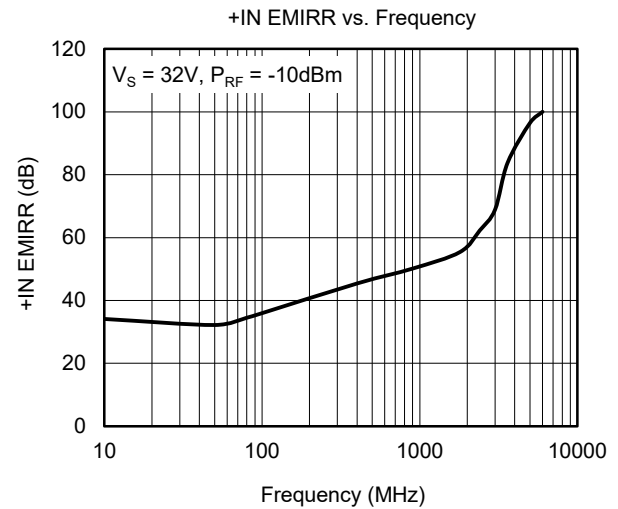
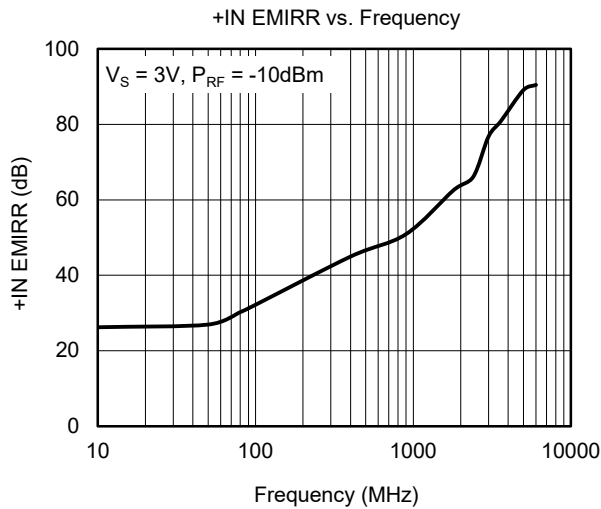
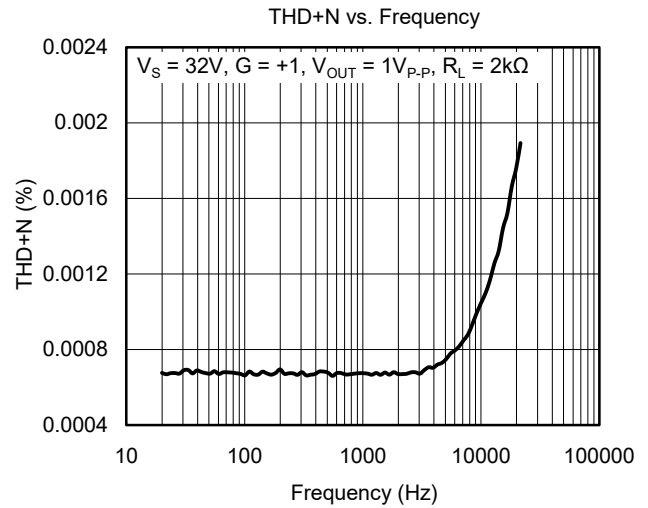
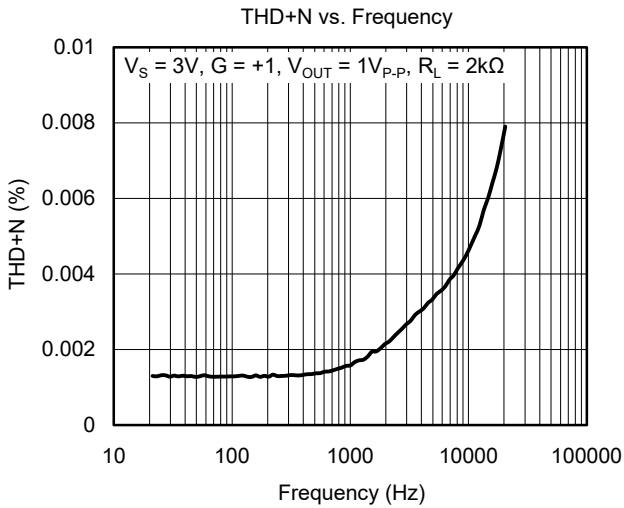
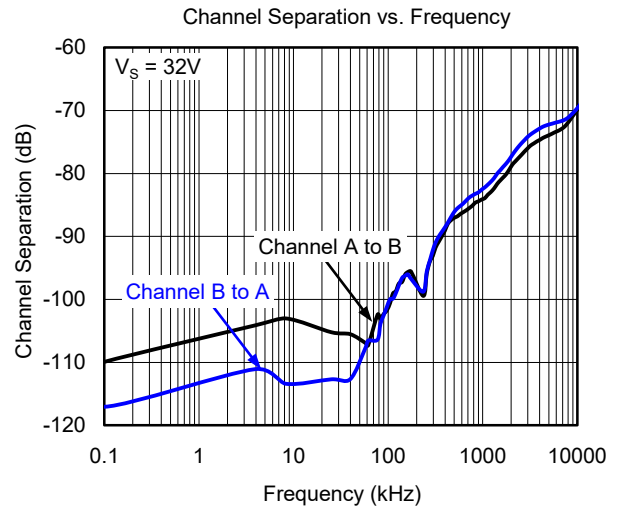
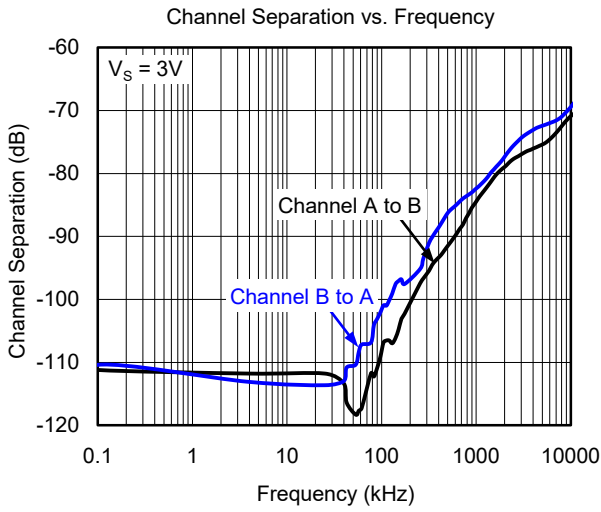

TYPICAL PERFORMANCE CHARACTERISTICS (continued)

At $T_A = +25^\circ\text{C}$, $V_{CM} = V_S/2$, unless otherwise noted.

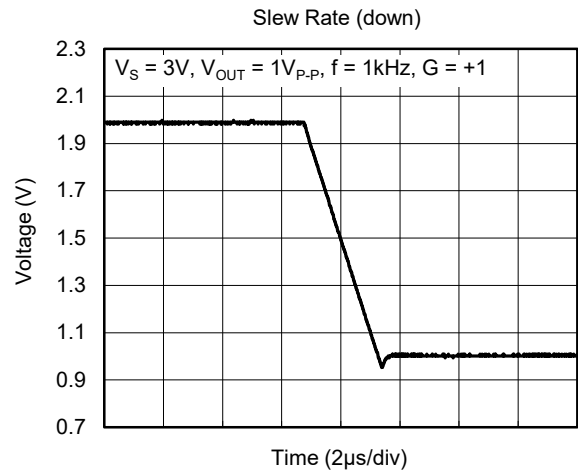
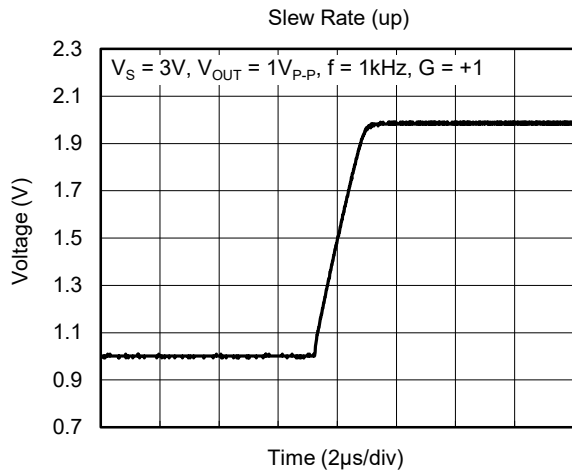
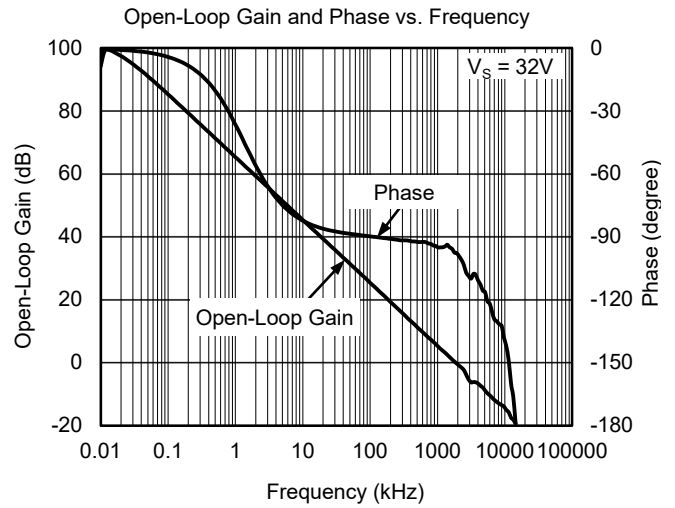
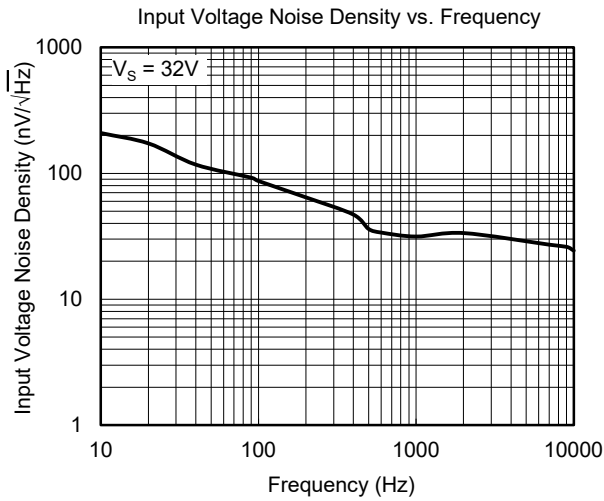
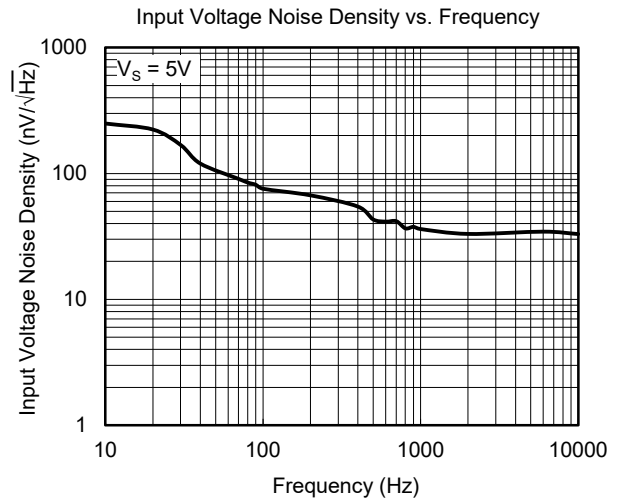
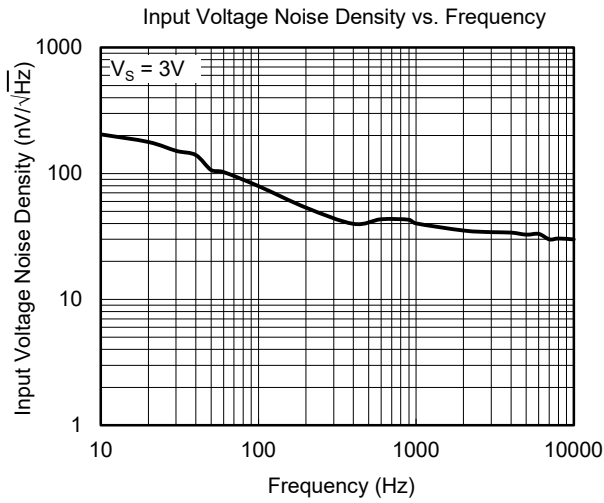

TYPICAL PERFORMANCE CHARACTERISTICS (continued)

At $T_A = +25^\circ\text{C}$, $V_{CM} = V_S/2$, unless otherwise noted.

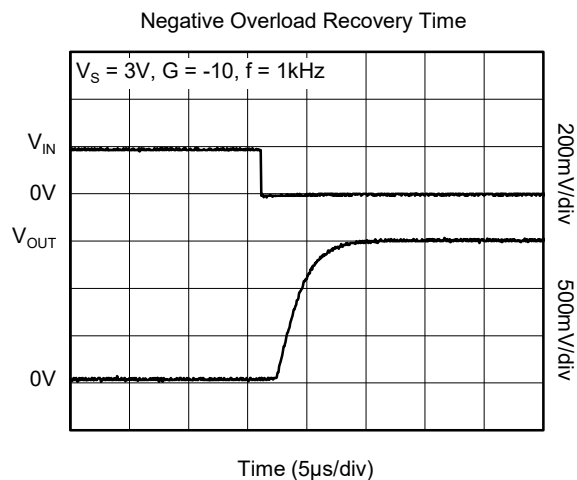
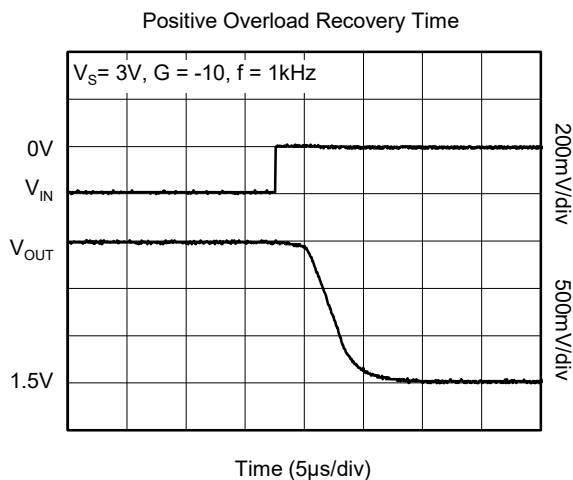
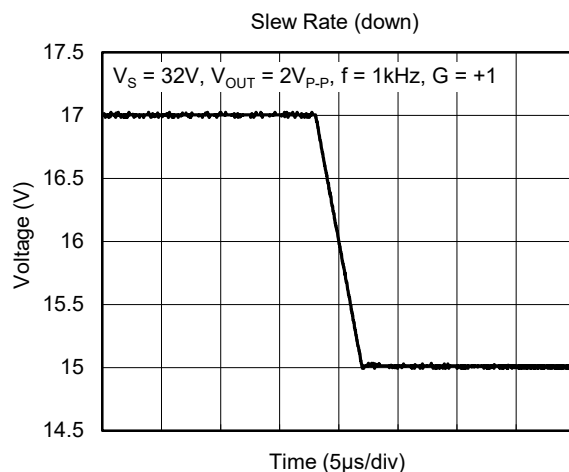
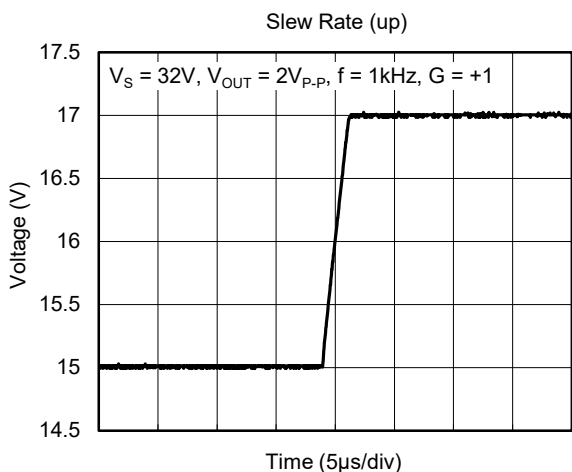
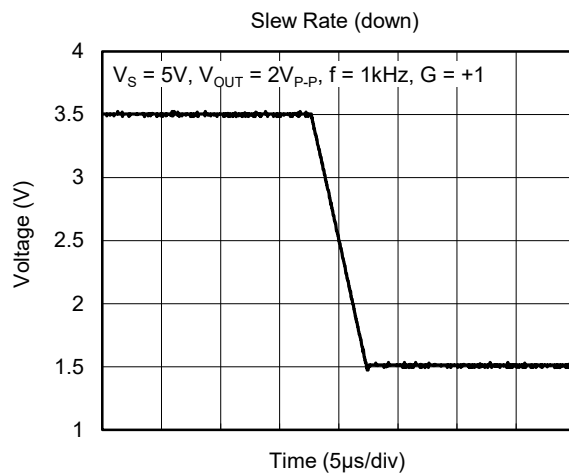
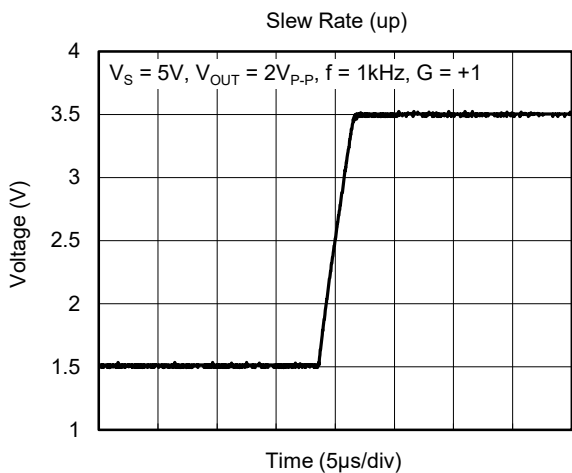

TYPICAL PERFORMANCE CHARACTERISTICS (continued)

At $T_A = +25^\circ\text{C}$, $V_{CM} = V_S/2$, unless otherwise noted.

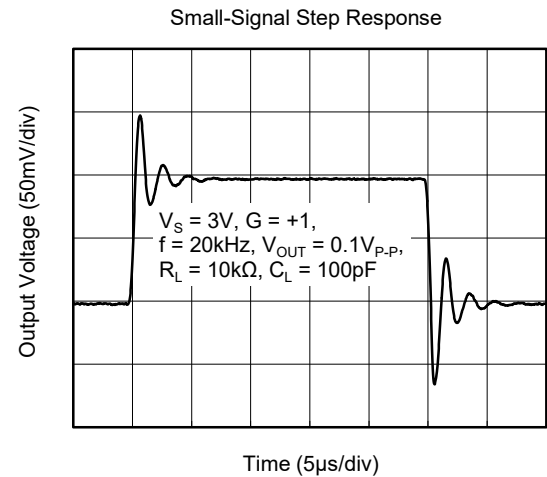
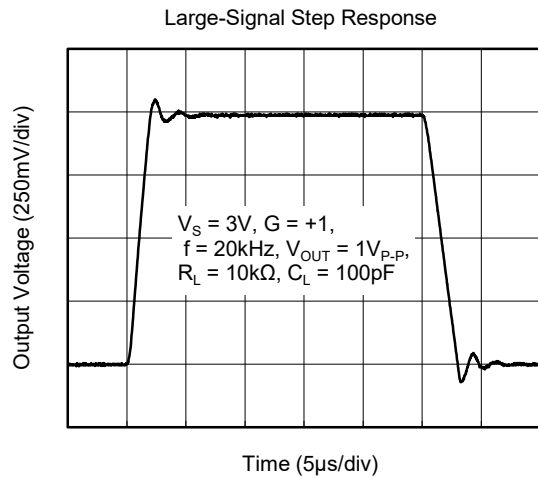
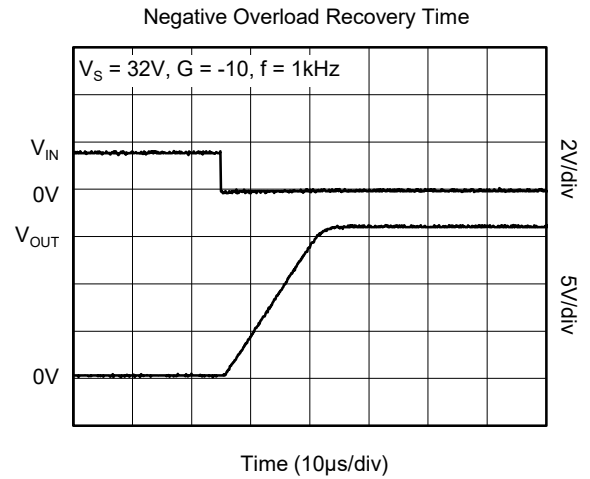
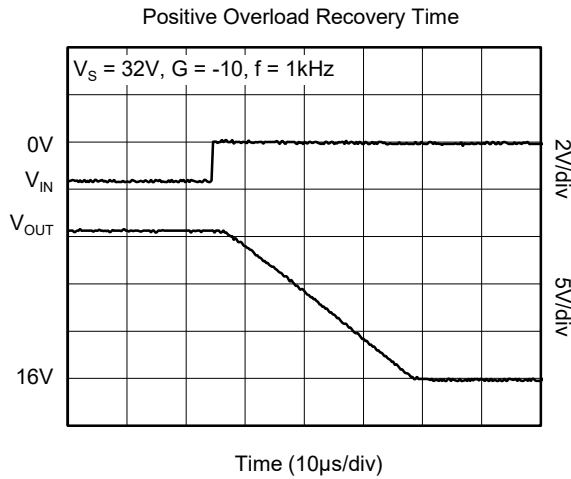
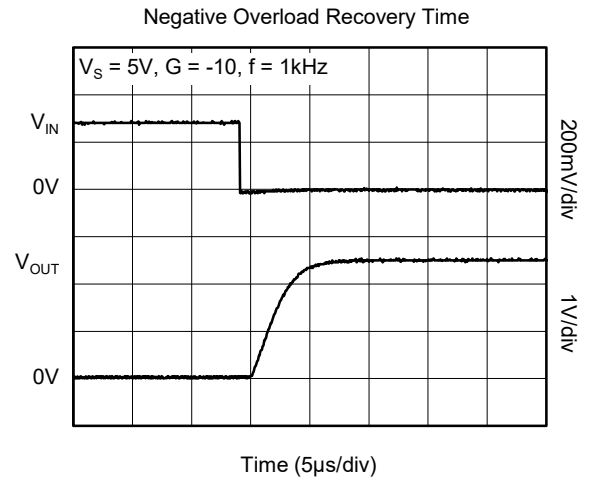
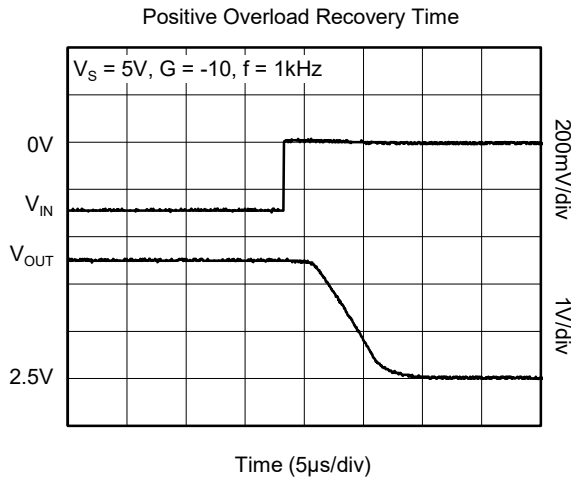

TYPICAL PERFORMANCE CHARACTERISTICS (continued)

At $T_A = +25^\circ\text{C}$, $V_{CM} = V_S/2$, unless otherwise noted.

Large-Signal Step Response

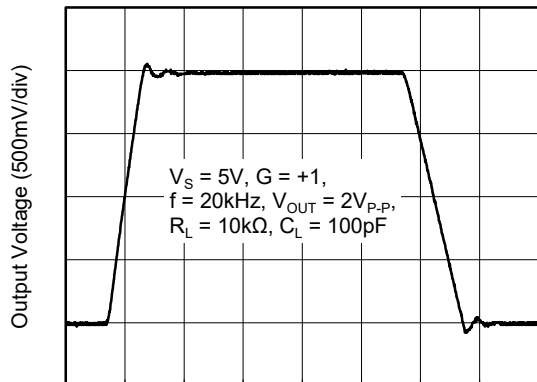

Time (5µs/div)

Small-Signal Step Response

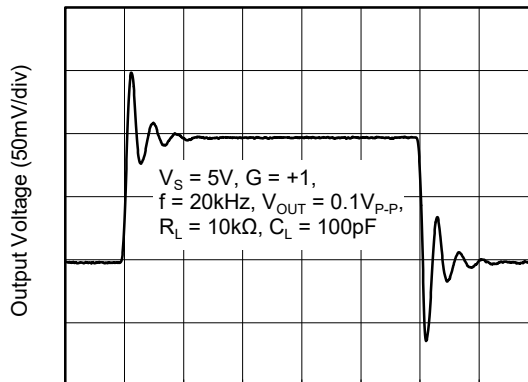

Time (5µs/div)

Large-Signal Step Response

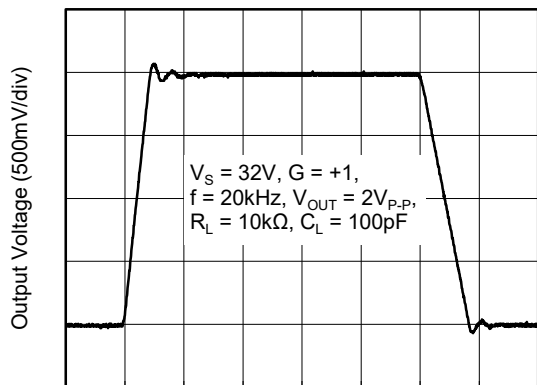

Time (5µs/div)

Small-Signal Step Response

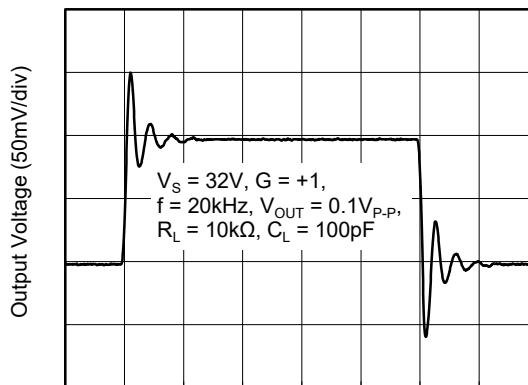

Time (5µs/div)

Turn-On Time

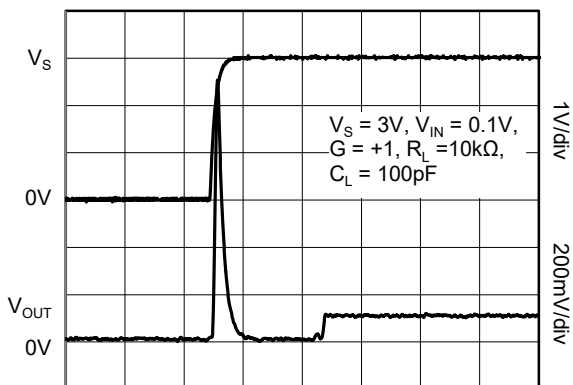

Time (20µs/div)

Turn-On Time

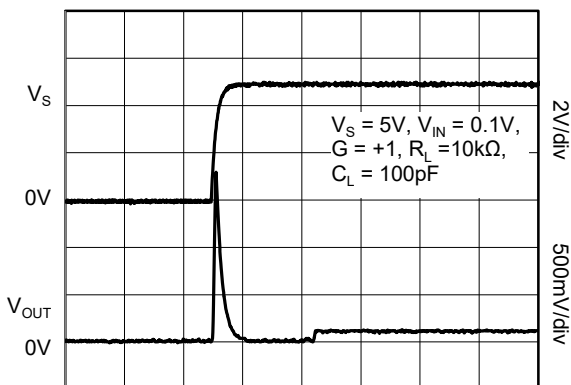

Time (20µs/div)

TYPICAL PERFORMANCE CHARACTERISTICS (continued)

At $T_A = +25^\circ\text{C}$, $V_{CM} = V_S/2$, unless otherwise noted.

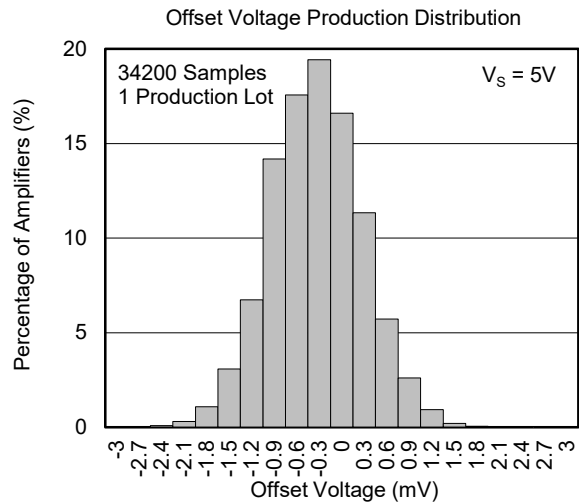
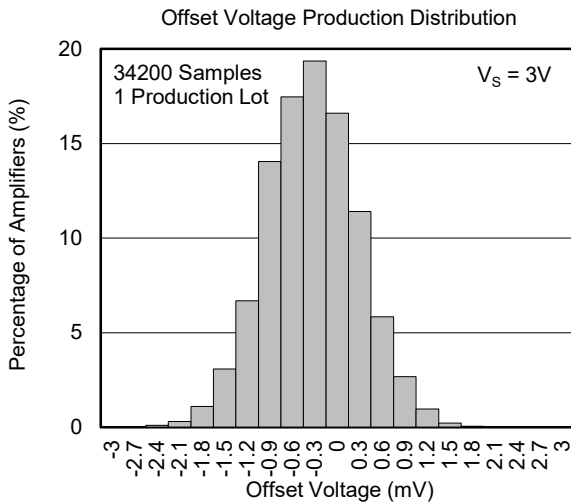
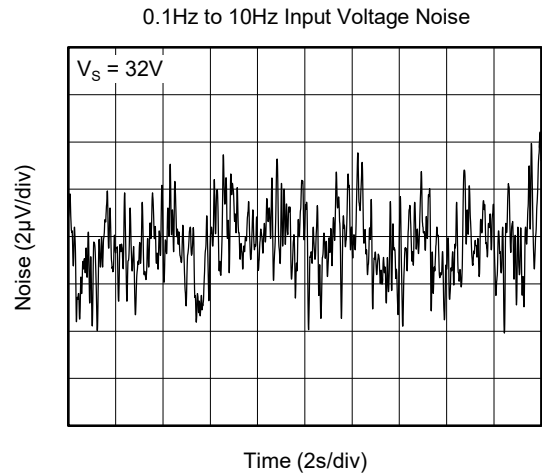
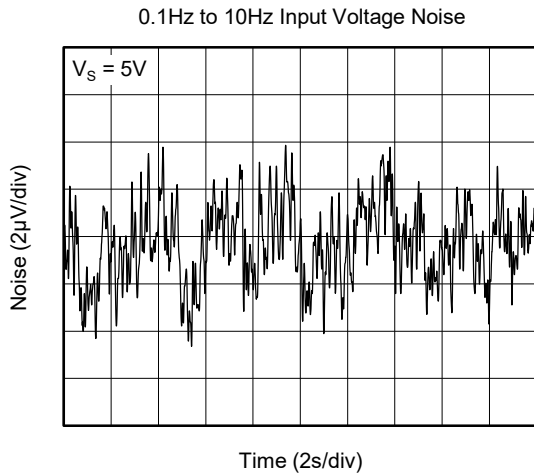
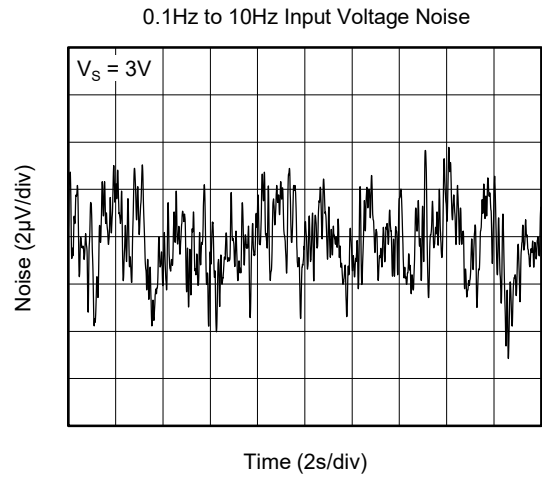
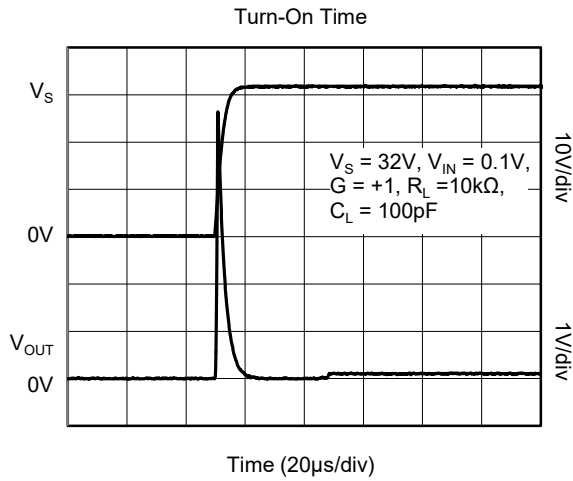

TYPICAL PERFORMANCE CHARACTERISTICS (continued)

At $T_A = +25^\circ\text{C}$, $V_{CM} = V_S/2$, unless otherwise noted.

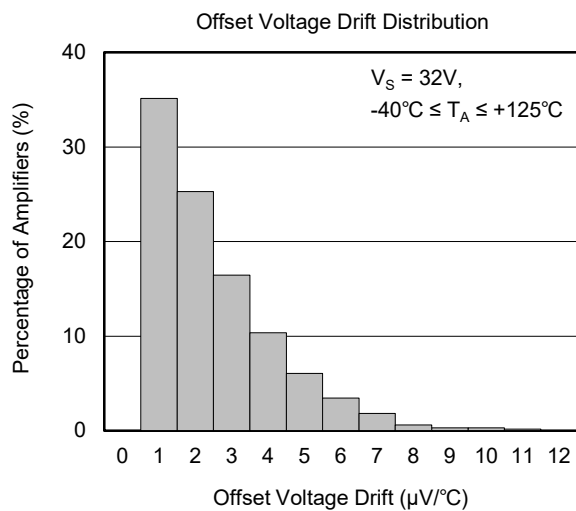
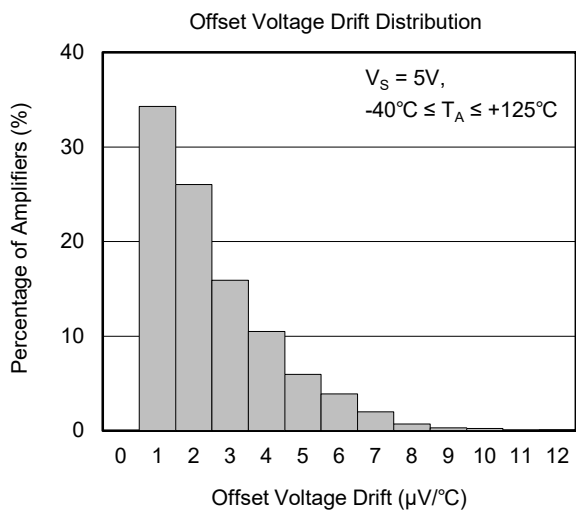
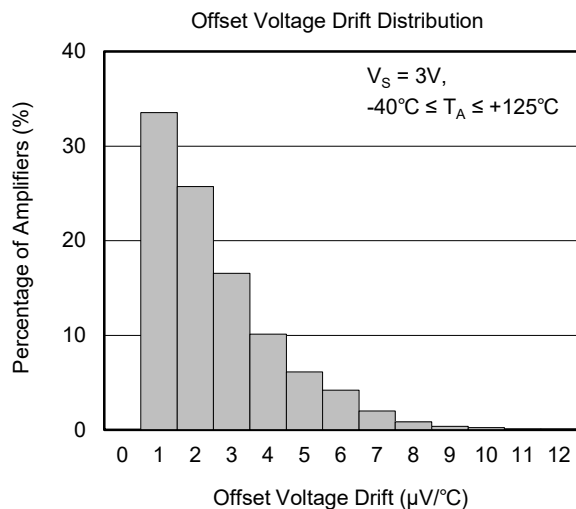
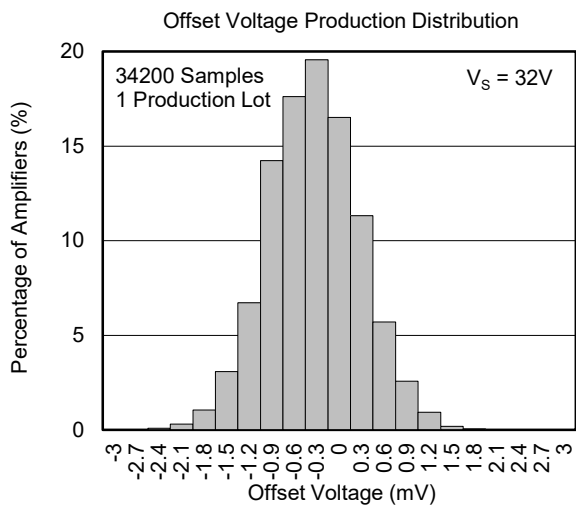

DETAILED DESCRIPTION

The LM358 consists of two independent, high-gain frequency-compensated operational amplifiers designed to operate from a single supply over a wide range of voltages. Operation from dual supplies is also possible if the difference between the two supplies is 3V to 32V, and V_S is at least 1.5V more positive than the input common mode voltage.

Applications include transducer amplifiers, DC amplification blocks, and all the conventional operational amplifier circuits that now can be implemented more easily in single-supply-voltage systems. For example, the device can be operated directly from the standard 5V supply used in digital systems and can easily provide the required interface electronics without additional $\pm 5V$ supplies.

Unity-Gain Bandwidth

The unity-gain bandwidth is the frequency up to which an amplifier with a unity gain may be operated without greatly distorting the signal. The device has a 1.1MHz unity-gain bandwidth.

APPLICATION INFORMATION

The LM358 operational amplifier is useful in a wide range of signal conditioning applications. Inputs can be powered before V_S for flexibility in multiple supply circuits.

Typical Application

A typical application for an operational amplifier is an inverting amplifier. This amplifier takes a positive voltage on the input and makes it a negative voltage of the same magnitude. In the same manner, it also makes negative voltages positive.

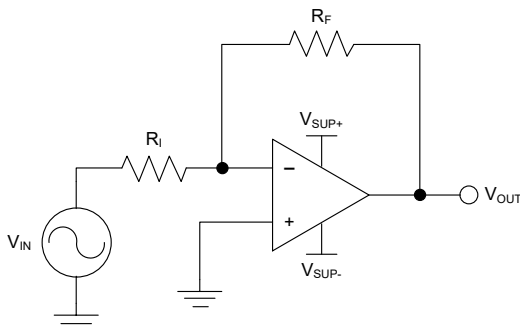

Figure 1. Application Schematic

Slew Rate

The slew rate is the rate at which an operational amplifier can change its output when there is a change on the input. The device has a 0.35V/ μs slew rate.

Input Common Mode Voltage Range

The valid common mode voltage range is from device ground to $V_S - 1.5V$. Inputs may exceed V_S up to the maximum V_S without device damage. At least one input must be in the valid input common mode voltage range for output to be correct phase. If both inputs exceed valid range then output phase is undefined. If either input is less than $-0.3V$ then input current should be limited to 1mA and output phase is undefined.

Device Functional Modes

The device is powered on when the supply is connected. This device can be operated as a single-supply operational amplifier or dual-supply amplifier depending on the application.

The supply voltage must be chosen such that it is larger than the input voltage range and output range. For instance, this application will scale a signal of $\pm 0.5V$ to $\pm 1.8V$. Setting the supply at $\pm 12V$ is sufficient to accommodate this application.

Determine the gain required by the inverting amplifier using Equation 1 and Equation 2:

$$A_v = \frac{V_{OUT}}{V_{IN}} \tag{1}$$

$$A_v = \frac{1.8}{-0.5} = -3.6 \tag{2}$$

Once the desired gain is determined, choose a value for R_I or R_F . Choosing a value in the $k\Omega$ range is desirable because the amplifier circuit will use currents in the milliamp range. This ensures the part will not draw too much current. This example will choose $10k\Omega$ for R_I which means $36k\Omega$ will be used for R_F . This was determined by Equation 3.

$$A_v = -\frac{R_F}{R_I} \tag{3}$$

REVISION HISTORY

NOTE: Page numbers for previous revisions may differ from page numbers in the current version.

Changes from Original (JUNE 2019) to REV.A	Page
Changed from product preview to production data.....	All

PACKAGE INFORMATION

PACKAGE OUTLINE DIMENSIONS

SOIC-8

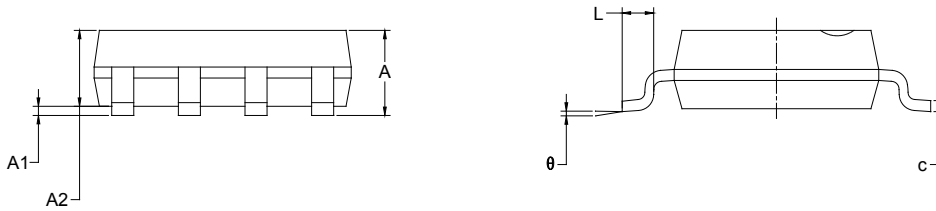
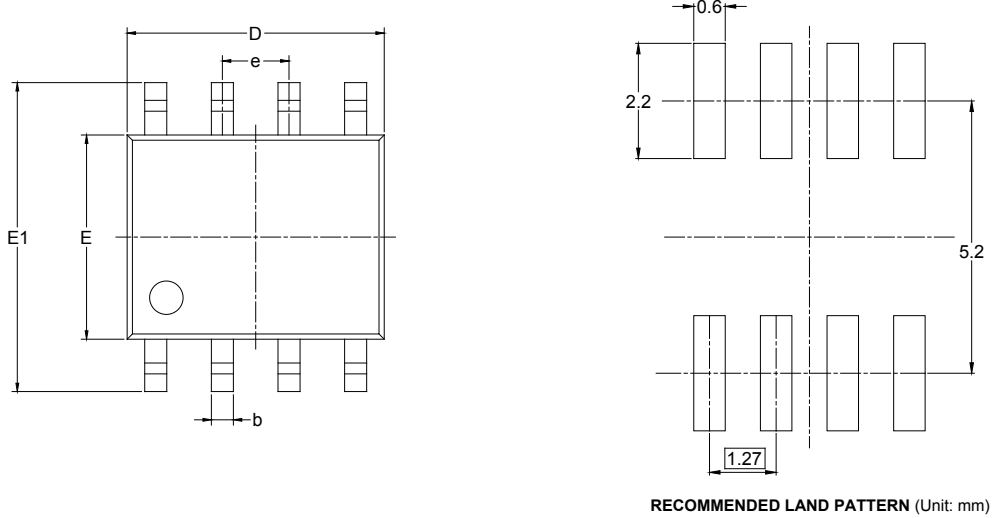

Symbol	Dimensions In Millimeters		Dimensions In Inches	
	MIN	MAX	MIN	MAX
A	1.350	1.750	0.053	0.069
A1	0.100	0.250	0.004	0.010
A2	1.350	1.550	0.053	0.061
b	0.330	0.510	0.013	0.020
c	0.170	0.250	0.006	0.010
D	4.700	5.100	0.185	0.200
E	3.800	4.000	0.150	0.157
E1	5.800	6.200	0.228	0.244
e	1.27 BSC		0.050 BSC	
L	0.400	1.270	0.016	0.050
θ	0°	8°	0°	8°

PACKAGE OUTLINE DIMENSIONS

MSOP-8



RECOMMENDED LAND PATTERN (Unit: mm)

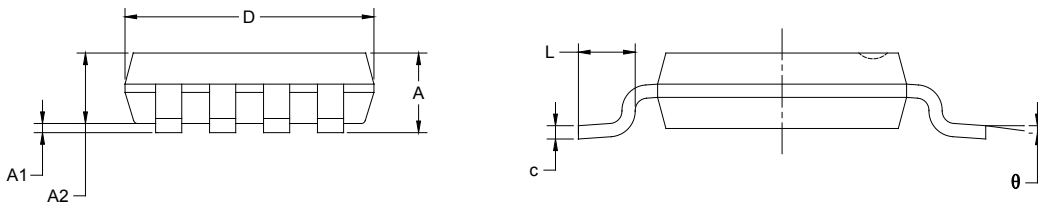

Symbol	Dimensions In Millimeters		Dimensions In Inches	
	MIN	MAX	MIN	MAX
A	0.820	1.100	0.032	0.043
A1	0.020	0.150	0.001	0.006
A2	0.750	0.950	0.030	0.037
b	0.250	0.380	0.010	0.015
c	0.090	0.230	0.004	0.009
D	2.900	3.100	0.114	0.122
E	2.900	3.100	0.114	0.122
E1	4.750	5.050	0.187	0.199
e	0.650 BSC		0.026 BSC	
L	0.400	0.800	0.016	0.031
θ	0°	6°	0°	6°

PACKAGE INFORMATION

TAPE AND REEL INFORMATION

REEL DIMENSIONS



TAPE DIMENSIONS



NOTE: The picture is only for reference. Please make the object as the standard.

KEY PARAMETER LIST OF TAPE AND REEL

Package Type	Reel Diameter	Reel Width W1 (mm)	A0 (mm)	B0 (mm)	K0 (mm)	P0 (mm)	P1 (mm)	P2 (mm)	W (mm)	Pin1 Quadrant
SOIC-8	13"	12.4	6.40	5.40	2.10	4.0	8.0	2.0	12.0	Q1
MSOP-8	13"	12.4	5.20	3.30	1.50	4.0	8.0	2.0	12.0	Q1

DD0001

PACKAGE INFORMATION

CARTON BOX DIMENSIONS



NOTE: The picture is only for reference. Please make the object as the standard.

KEY PARAMETER LIST OF CARTON BOX

Reel Type	Length (mm)	Width (mm)	Height (mm)	Pizza/Carton
13"	386	280	370	5

DD0002