

# SGM8968-1/SGM8968-2/SGM8968-4

## 1.6mA, 10MHz, High Precision, Rail-to-Rail I/O, Low Noise, CMOS Operational Amplifiers

---

### GENERAL DESCRIPTION

The SGM8968-1/2/4 are a family of single, dual and quad rail-to-rail input and output operational amplifiers with 10MHz gain-bandwidth product and 20V/ $\mu$ s slew rate, while consuming only 1.6mA quiescent current per amplifier at 5.5V.

The SGM8968-1/2/4 feature a 240 $\mu$ V maximum input offset, and the devices are optimized for low voltage operation from 1.8V to 5.5V.

The single SGM8968-1 is available in Green SOT-23-5 and SOIC-8 packages. The dual SGM8968-2 is available in Green SOIC-8 and MSOP-8 packages. The quad SGM8968-4 is available in Green SOIC-14 and TSSOP-14 packages. They are specified over the extended industrial temperature range (-40°C to +125°C).

### FEATURES

- Rail-to-Rail Input and Output
- Input Offset Voltage: 240 $\mu$ V (MAX)
- High Gain-Bandwidth Product: 10MHz
- High Slew Rate: 20V/ $\mu$ s
- Settling Time to 0.1% with 2V Step: 280ns
- Overload Recovery Time: 100ns
- Low Noise: 8nV/ $\sqrt{\text{Hz}}$  at 10kHz
- Supply Voltage Range: 1.8V to 5.5V
- Input Voltage Range: -0.1V to 5.6V with  $V_S = 5.5V$
- Low Power:
  - Supply Current: 1.6mA/Amplifier (TYP)
- -40°C to +125°C Operating Temperature Range
- Small Packaging:
  - SGM8968-1 Available in Green SOT-23-5 and SOIC-8 Packages
  - SGM8968-2 Available in Green SOIC-8 and MSOP-8 Packages
  - SGM8968-4 Available in Green SOIC-14 and TSSOP-14 Packages

### APPLICATIONS

Sensor  
Audio  
Active Filter  
A/D Converter  
Communication  
Test Equipment  
Cellular and Cordless Phone  
Laptop and PDA  
Photodiode Amplification  
Battery-Powered Instrumentation



**PIN CONFIGURATIONS**

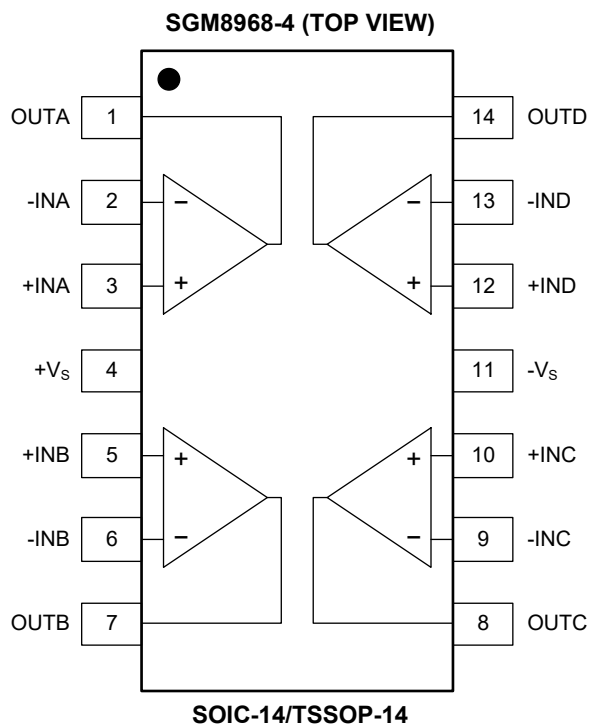
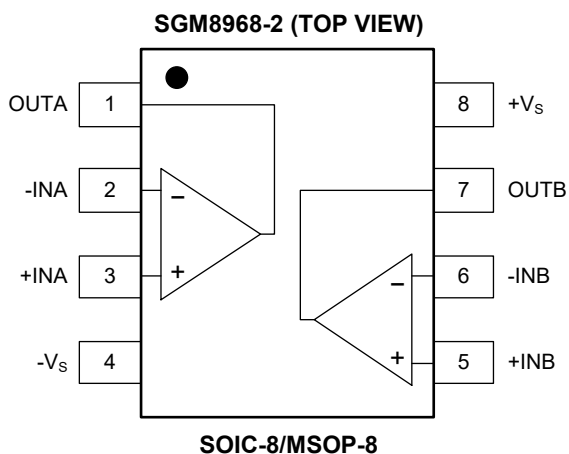
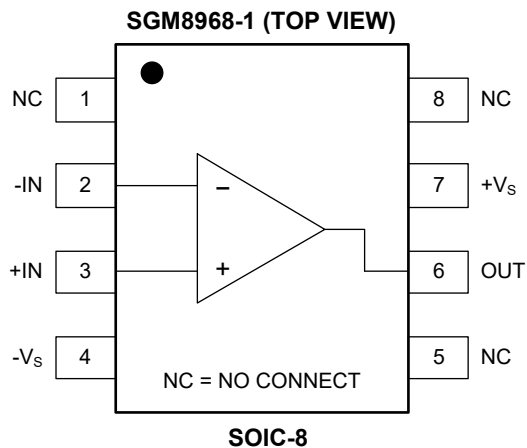
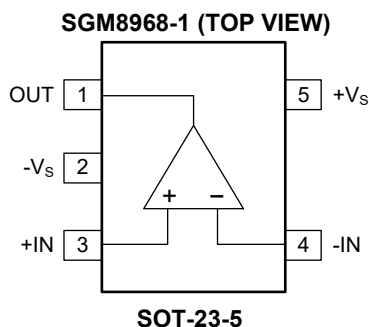

## ELECTRICAL CHARACTERISTICS

(At  $T_A = +25^\circ\text{C}$ ,  $V_S = 1.8\text{V}$  to  $5.5\text{V}$  or  $\pm 0.9\text{V}$  to  $\pm 2.75\text{V}$ ,  $V_{CM} = V_S/2$  and  $R_L = 10\text{k}\Omega$  connected to  $V_S/2$ , Full =  $-40^\circ\text{C}$  to  $+125^\circ\text{C}$ , unless otherwise noted.)

PARAMETER	SYMBOL	CONDITIONS	TEMP	MIN	TYP	MAX	UNITS
<b>Input Characteristics</b>							
Input Offset Voltage	$V_{OS}$		+25°C		50	240	$\mu\text{V}$
			Full			700	
Input Bias Current	$I_B$		+25°C		6	120	$\text{pA}$
			Full			6500	
Input Offset Current	$I_{OS}$		+25°C		6	120	$\text{pA}$
			Full			1500	
Input Common Mode Voltage Range	$V_{CM}$		Full	$(-V_S) - 0.1$		$(+V_S) + 0.1$	V
Common Mode Rejection Ratio	CMRR	$V_S = 5.5\text{V}$ , $V_{CM} = -0.1\text{V}$ to $5.6\text{V}$	+25°C	84	95		dB
			Full	81			
		$V_S = 1.8\text{V}$ , $V_{CM} = -0.1\text{V}$ to $1.9\text{V}$	+25°C	75	94		
			Full	71			
Open-Loop Voltage Gain	$A_{OL}$	$V_S = \pm 0.9\text{V}$ , $R_L = 1\text{k}\Omega$ , $(-V_S) + 0.25\text{V} < V_{OUT} < (+V_S) - 0.25\text{V}$	+25°C	90	117		dB
			Full	87			
		$V_S = \pm 2.75\text{V}$ , $R_L = 1\text{k}\Omega$ , $(-V_S) + 0.25\text{V} < V_{OUT} < (+V_S) - 0.25\text{V}$	+25°C	102	130		
			Full	99			
		$V_S = \pm 0.9\text{V}$ , $R_L = 10\text{k}\Omega$ , $(-V_S) + 0.15\text{V} < V_{OUT} < (+V_S) - 0.15\text{V}$	+25°C	93	117		
			Full	90			
		$V_S = \pm 2.75\text{V}$ , $R_L = 10\text{k}\Omega$ , $(-V_S) + 0.15\text{V} < V_{OUT} < (+V_S) - 0.15\text{V}$	+25°C	102	128		
			Full	99			
<b>Output Characteristics</b>							
Output Voltage Swing from Rail	$V_{OUT}$	$V_S = 5.5\text{V}$ , $R_L = 1\text{k}\Omega$	+25°C		60	80	$\text{mV}$
			Full			88	
		$V_S = 5.5\text{V}$ , $R_L = 10\text{k}\Omega$	+25°C		8	13	
			Full			15	
Output Current ( $I_{OUT}$ )	$I_{OUT}$	$V_S = 5.5\text{V}$	+25°C	31	80		$\text{mA}$
			Full	19			
<b>Power Supply</b>							
Operating Voltage Range	$V_S$		Full	1.8		5.5	V
Power Supply Rejection Ratio	PSRR	$V_S = 1.8\text{V}$ to $5.5\text{V}$ , $V_{CM} = (-V_S) + 0.5\text{V}$	+25°C	89	110		dB
			Full	86			
Quiescent Current/Amplifier	$I_Q$	$I_{OUT} = 0$	+25°C		1.6	2.1	$\text{mA}$
			Full			2.2	
<b>Dynamic Performance</b>							
Gain-Bandwidth Product	GBP	$V_S = 5\text{V}$	+25°C		10		MHz
Phase Margin	$\phi_O$	$V_S = 5\text{V}$	+25°C		60		°
Slew Rate	SR	$V_S = 5\text{V}$ , $G = +1$ , 2V output step	+25°C		20		V/ $\mu\text{s}$
Settling Time to 0.1%	$t_S$	$V_S = 5\text{V}$ , $G = +1$ , 2V output step	+25°C		280		ns
Overload Recovery Time		$V_S = 5\text{V}$ , $V_{IN} \times G = V_S$	+25°C		100		ns
Total Harmonic Distortion + Noise	THD+N	$V_{OUT} = 4V_{P-P}$ , $G = +1$ , $f = 10\text{kHz}$ , BW = 22Hz to 80kHz	+25°C		0.0005		%
<b>Noise Performance</b>							
Input Voltage Noise Density	$e_n$	$f = 1\text{kHz}$	+25°C		18		$\text{nV}/\sqrt{\text{Hz}}$
		$f = 10\text{kHz}$	+25°C		8		

**TYPICAL PERFORMANCE CHARACTERISTICS**

At  $T_A = +25^\circ\text{C}$ ,  $V_S = \pm 2.75\text{V}$  and  $R_L = 10\text{k}\Omega$ , unless otherwise noted.

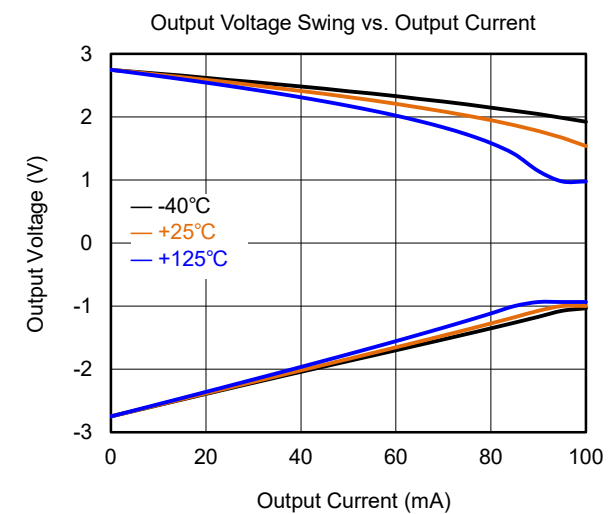
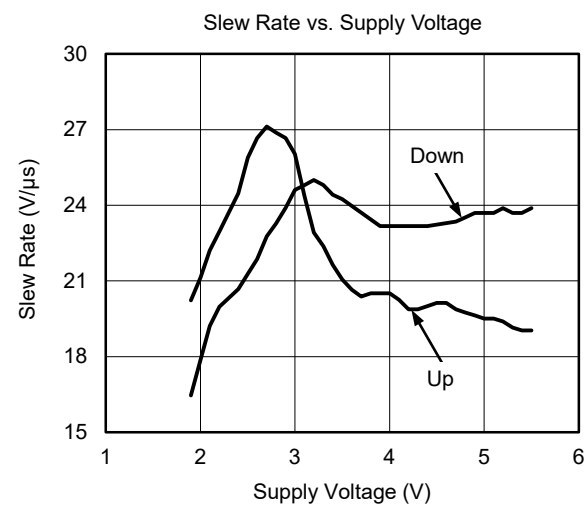
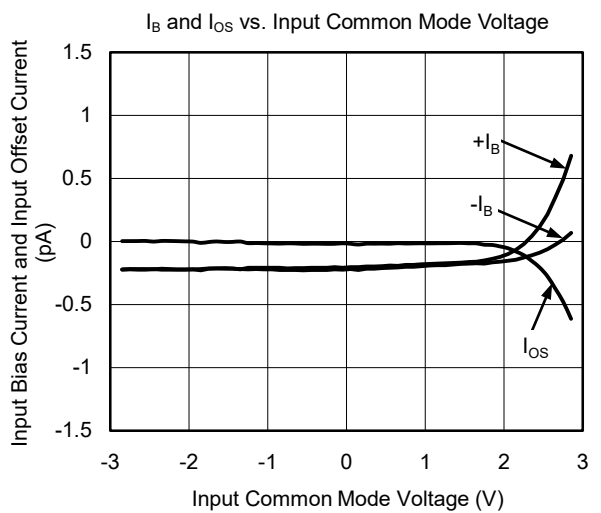
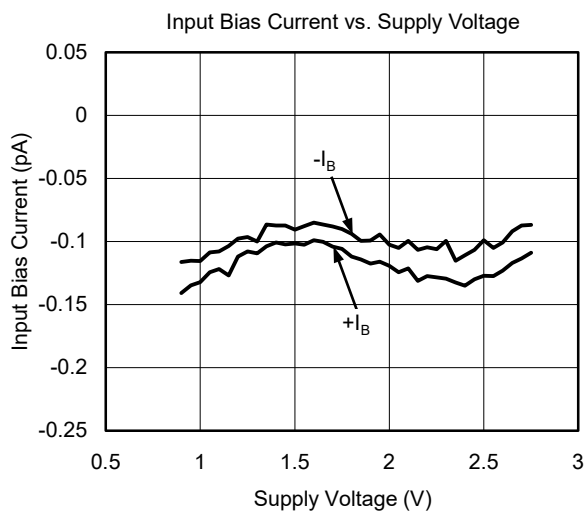
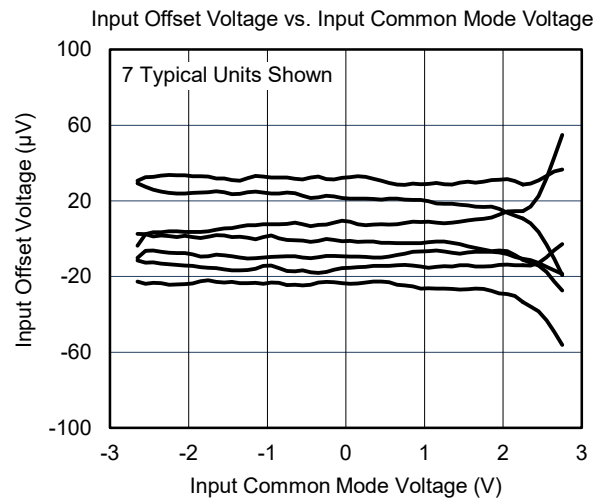
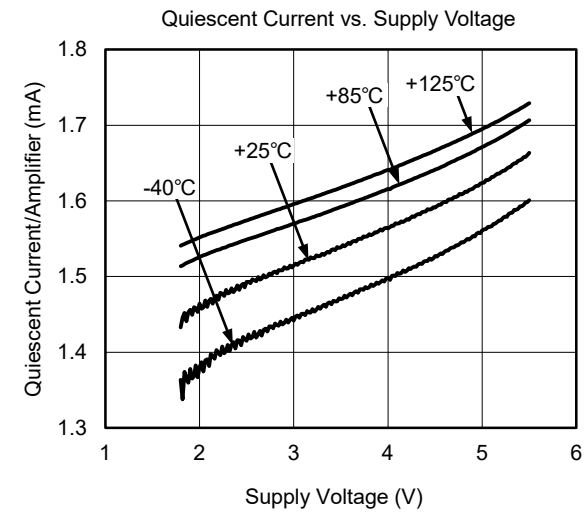

**TYPICAL PERFORMANCE CHARACTERISTICS (continued)**

At  $T_A = +25^\circ\text{C}$ ,  $V_S = \pm 2.75\text{V}$  and  $R_L = 10\text{k}\Omega$ , unless otherwise noted.

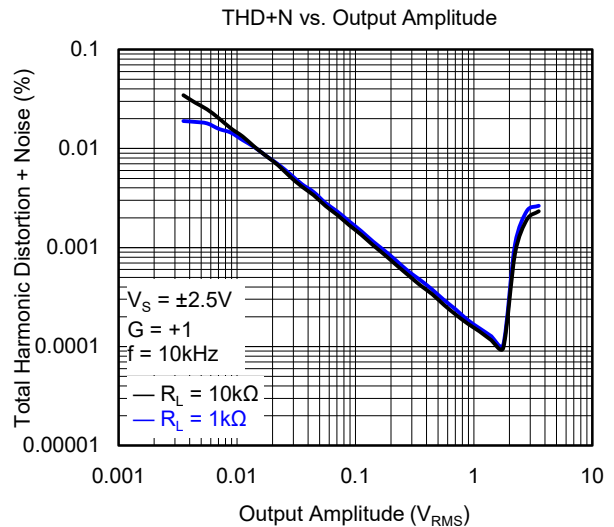
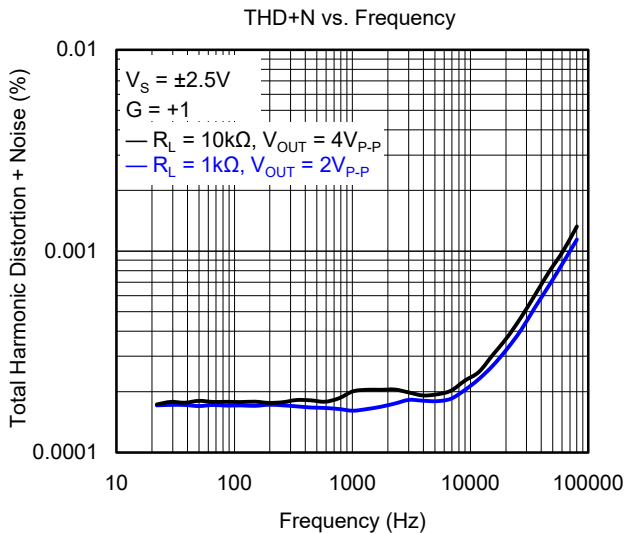
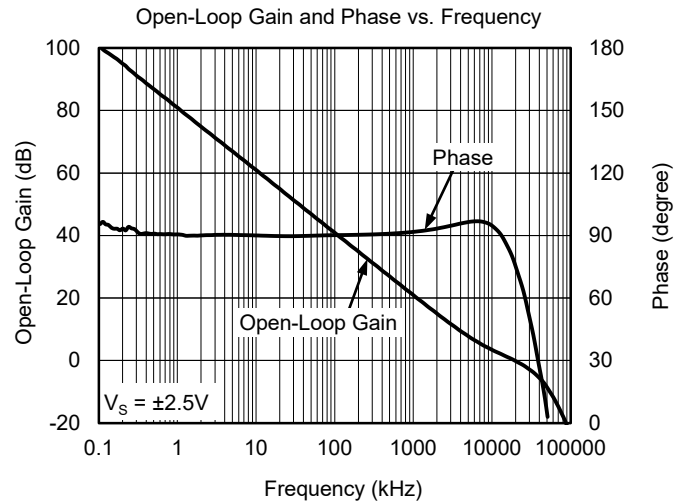
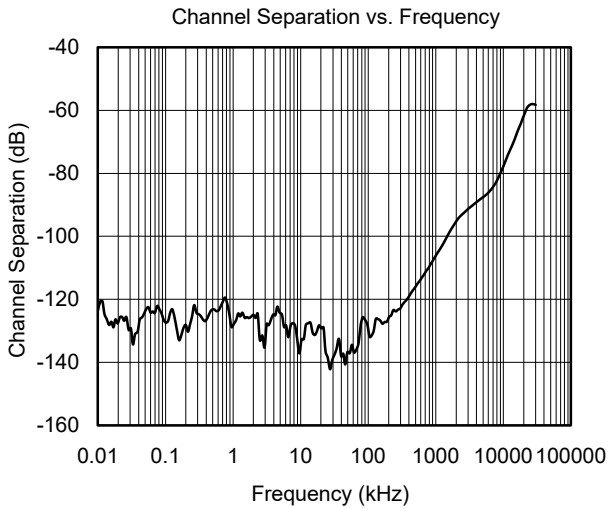
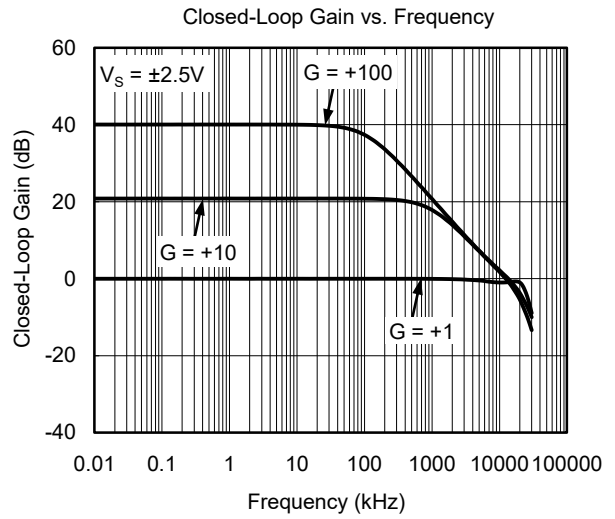
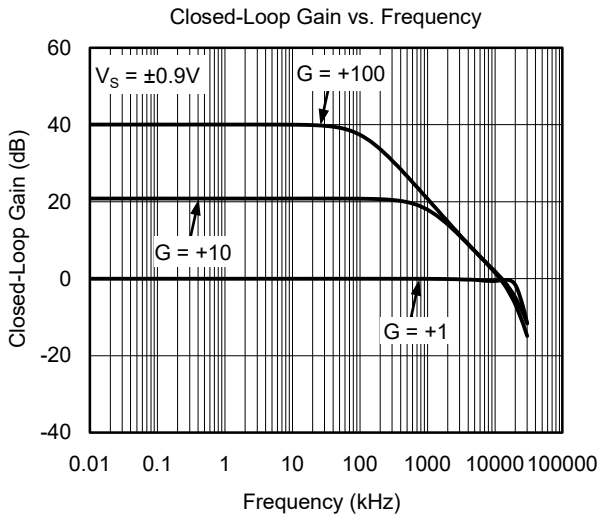

**TYPICAL PERFORMANCE CHARACTERISTICS (continued)**

At  $T_A = +25^\circ\text{C}$ ,  $V_S = \pm 2.75\text{V}$  and  $R_L = 10\text{k}\Omega$ , unless otherwise noted.

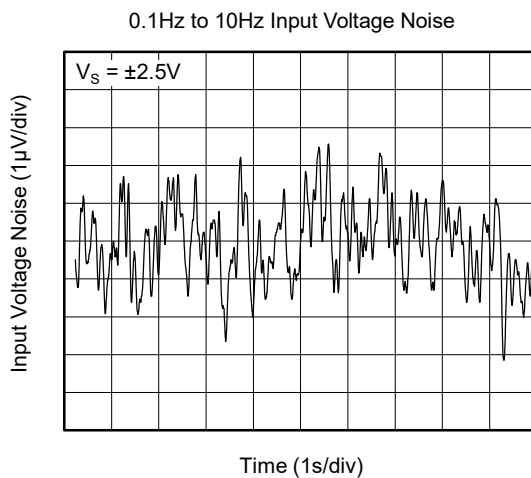
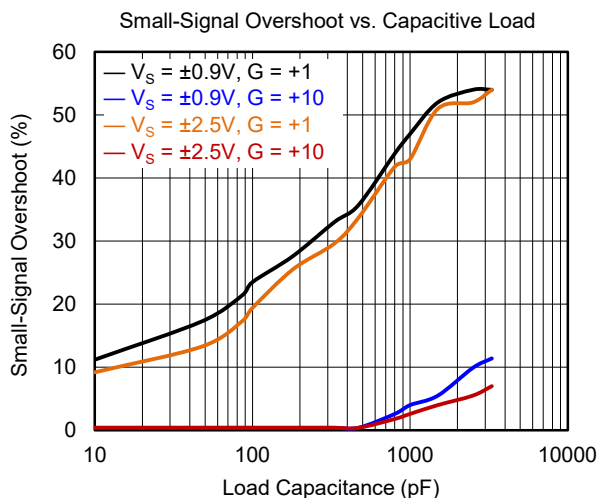
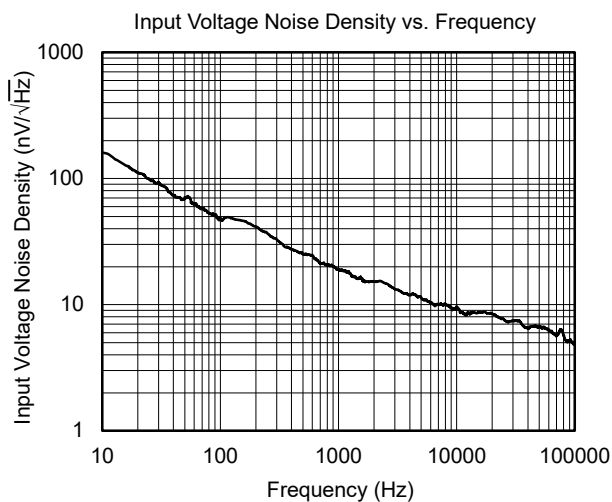
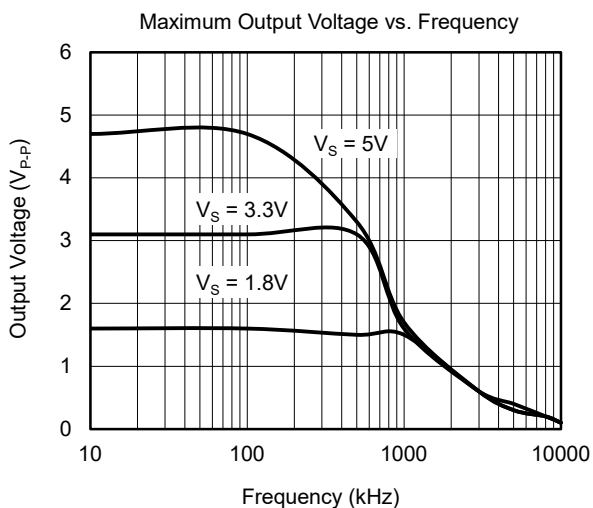
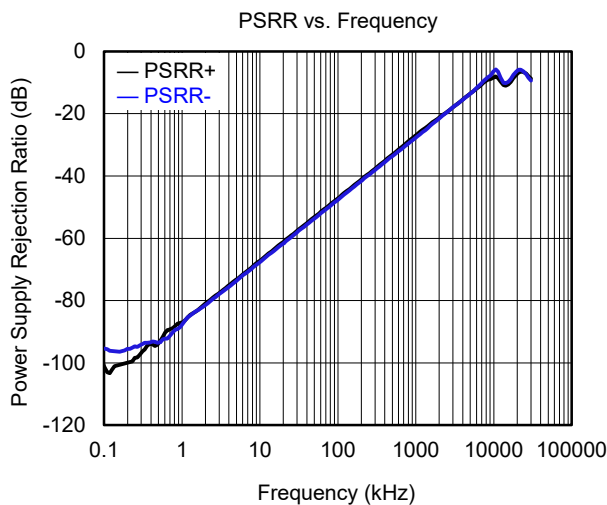
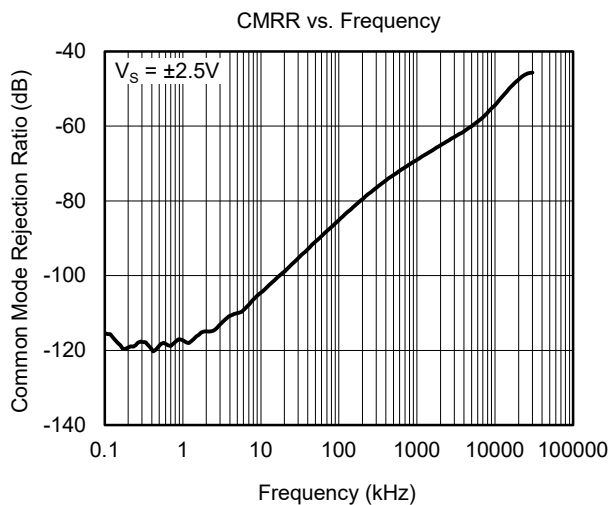

**TYPICAL PERFORMANCE CHARACTERISTICS (continued)**

At  $T_A = +25^\circ\text{C}$ ,  $V_S = \pm 2.75\text{V}$  and  $R_L = 10\text{k}\Omega$ , unless otherwise noted.

Small-Signal Step Response

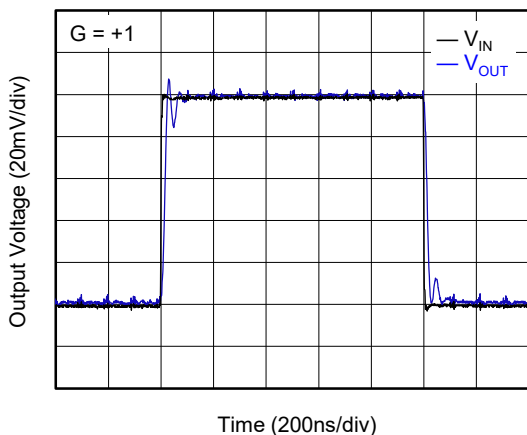

Small-Signal Step Response

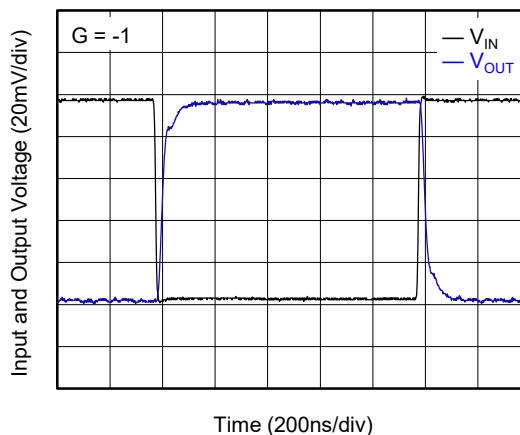

Large-Signal Step Response

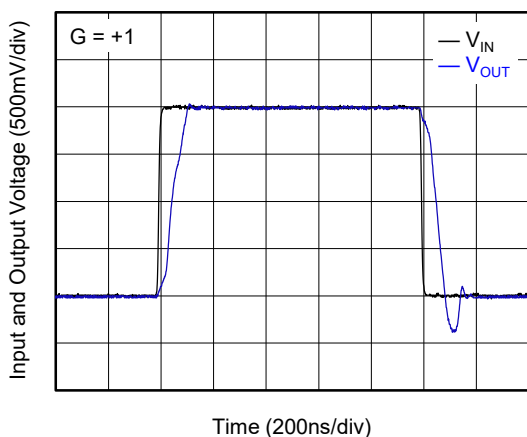

No Phase Reversal

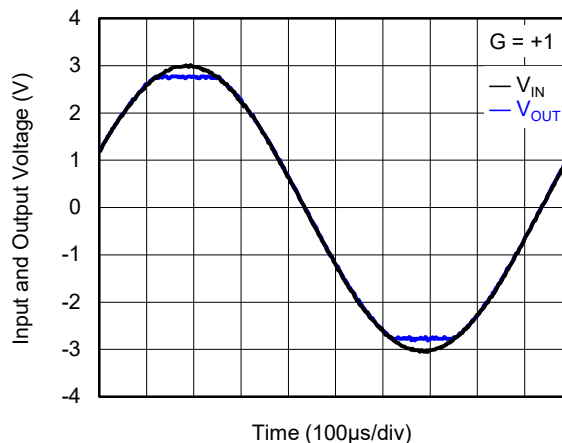

Input Offset Voltage Production Distribution

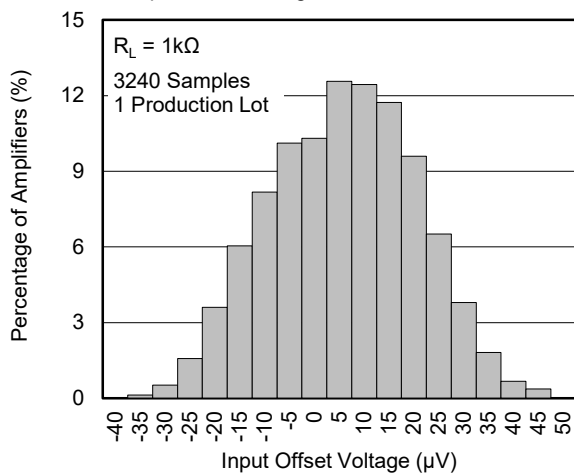



## APPLICATION NOTES

### Rail-to-Rail Input

The input common mode voltage range of the SGM8968-1/2/4 extends 100mV beyond the supply rails for the full supply voltage range of 1.8V to 5.5V. Diodes between the inputs and the supply rails keep the input voltage from exceeding the rails.

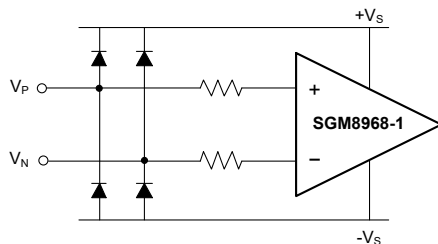

**Figure 1. Equivalent Input Circuit**

### Input Protection

The SGM8968-1/2/4 family incorporates internal ESD protection circuits on all pins. For input and output pins, this protection primarily consists of current-steering diodes connected between the input and power supply pins. Therefore, as well as keeping the input voltage below the maximum rating, it is also important to limit the input current to less than 10mA. Figure 2 shows how a series input resistor can be added to the driven input to limit the input current. The added resistor contributes thermal noise at the amplifier input and the value must be kept to a minimum in noise-sensitive applications.

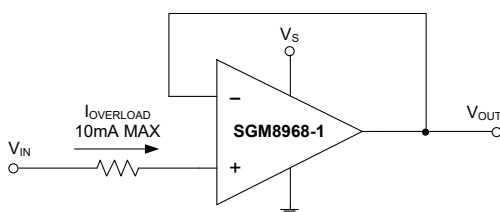

**Figure 2. Input Current Protection**

### Rail-to-Rail Output

The minimum output voltage will be within millivolts of ground for single-supply operation where the load is referenced to ground ( $-V_S$ ). With a 5.5V supply and the load tied to ground, the typical output swings from 0.008V to 5.492V.

### Driving Capacitive Loads

The SGM8968-1/2/4 are unity-gain stable for capacitive load up to 1nF. Applications that require greater capacitive drive capability should use an isolation resistor between the output and the capacitive load (Figure 3). Note that this alternative results in a loss of gain accuracy because  $R_{ISO}$  forms a voltage divider with the  $R_{LOAD}$ .

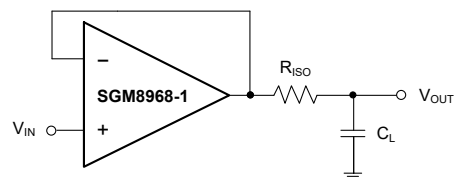

**Figure 3. Using Isolation Resistor to Improve Stability when Driving Heavy Capacitive Load**

### Power Supply Bypassing and Layout

Power supply pins are actually inputs to the amplifiers. Care must be taken to provide the amplifiers with a clean, low noise DC voltage source.

Power supply bypassing is employed to provide a low impedance path to ground for noise and undesired signals at all frequencies. This cannot be achieved with a single capacitor type; but with a variety of capacitors in parallel, the bandwidth of power supply bypassing can be greatly extended. The bypass capacitors have two functions:

1. Provide a low impedance path for noise and undesired signals from the supply pins to ground.
2. Provide local stored charge for fast switching conditions and minimize the voltage drop at the supply pins during transients. This is typically achieved with large electrolytic capacitors.

## APPLICATION NOTES (continued)

Good quality ceramic chip capacitors should be used and always kept as close as possible to the amplifier package. A parallel combination of a  $0.1\mu\text{F}$  ceramic and a  $10\mu\text{F}$  electrolytic covers a wide range of rejection for unwanted noise. The  $10\mu\text{F}$  capacitor is less critical for high frequency bypassing, and in most cases, one per supply line is sufficient. The values of capacitors are circuit-dependent and should be determined by the system's requirements.

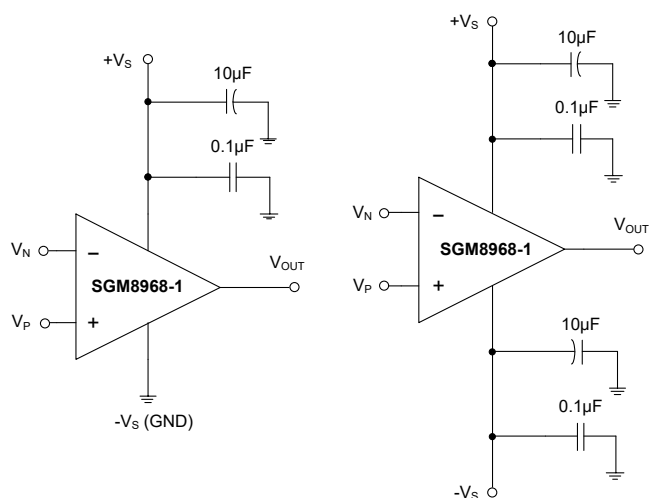

**Figure 4. Amplifier with Bypass Capacitors**

### Grounding

Separate grounding for analog and digital portions of circuitry is one of the simplest and most effective methods of noise suppression. One or more layers on multilayer PCBs are usually devoted to ground planes.

A ground plane helps distribute heat and reduces EMI noise pickup. Make sure to physically separate digital and analog grounds, paying attention to the flow of the ground current.

### Input-to-Output Coupling

To minimize capacitive coupling, run the input traces as far away from the supply or output traces as possible. If these traces cannot be kept separate, crossing the sensitive trace perpendicular is much better as opposed to in parallel with the noisy trace. This helps reduce unwanted positive feedback.

## TYPICAL APPLICATION CIRCUITS

### Difference Amplifier

The circuit shown in Figure 5 performs the difference function. If the resistor ratios are equal ( $R_4/R_3 = R_2/R_1$ ), then  $V_{OUT} = (V_P - V_N) \times R_2/R_1 + V_{REF}$ .

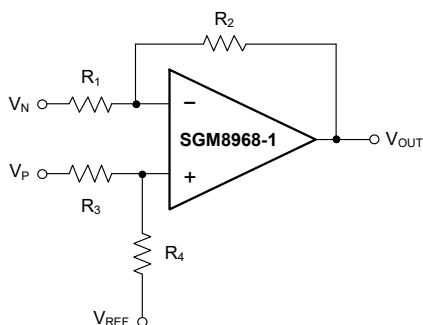

Figure 5. Difference Amplifier

### High Input Impedance Difference Amplifier

The circuit in Figure 6 performs the same function as that in Figure 5 but with a high input impedance.

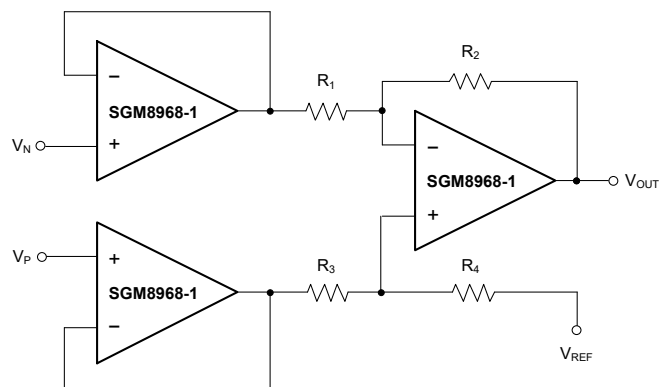

Figure 6. High Input Impedance Difference Amplifier

### Active Low-Pass Filter

The low-pass filter shown in Figure 7 has a DC gain of  $(-R_2/R_1)$  and the -3dB corner frequency is  $1/2\pi R_2 C$ . Make sure the filter bandwidth is within the bandwidth of the amplifier. Feedback resistors with large values can couple with parasitic capacitance and cause undesired effects such as ringing or oscillation in high-speed amplifiers. Keep resistor values as low as possible and consistent with output loading consideration.

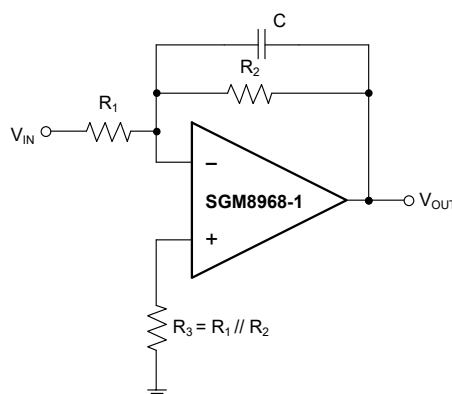
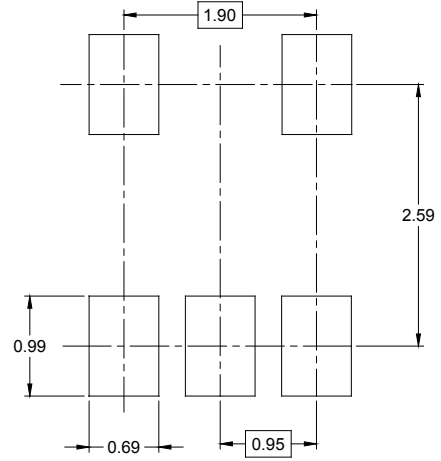
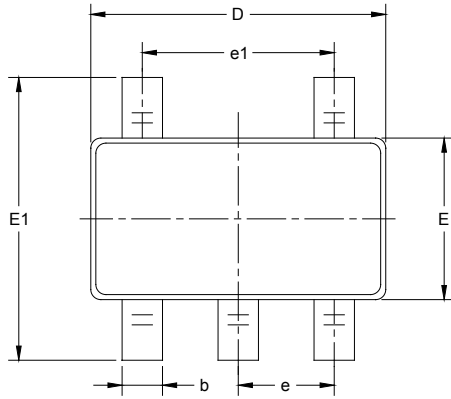

Figure 7. Active Low-Pass Filter

# PACKAGE INFORMATION

## PACKAGE OUTLINE DIMENSIONS

### SOT-23-5



RECOMMENDED LAND PATTERN (Unit: mm)

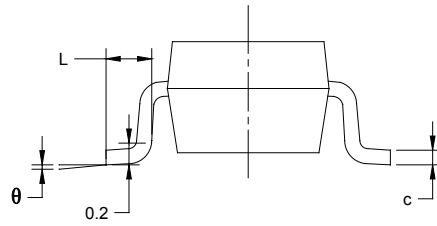
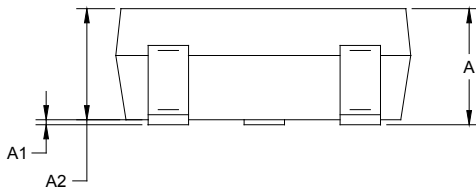

Symbol	Dimensions In Millimeters		Dimensions In Inches	
	MIN	MAX	MIN	MAX
A	1.050	1.250	0.041	0.049
A1	0.000	0.100	0.000	0.004
A2	1.050	1.150	0.041	0.045
b	0.300	0.500	0.012	0.020
c	0.100	0.200	0.004	0.008
D	2.820	3.020	0.111	0.119
E	1.500	1.700	0.059	0.067
E1	2.650	2.950	0.104	0.116
e	0.950 BSC		0.037 BSC	
e1	1.900 BSC		0.075 BSC	
L	0.300	0.600	0.012	0.024
$\theta$	0°	8°	0°	8°

# PACKAGE INFORMATION

## PACKAGE OUTLINE DIMENSIONS

### SOIC-8

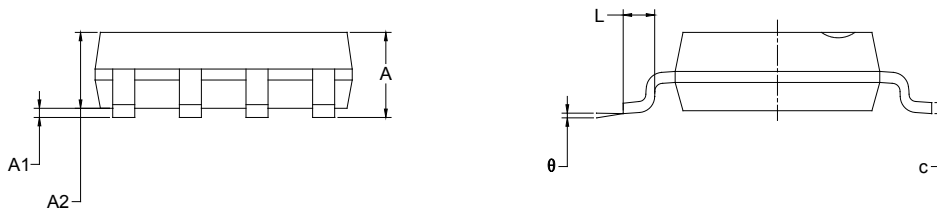
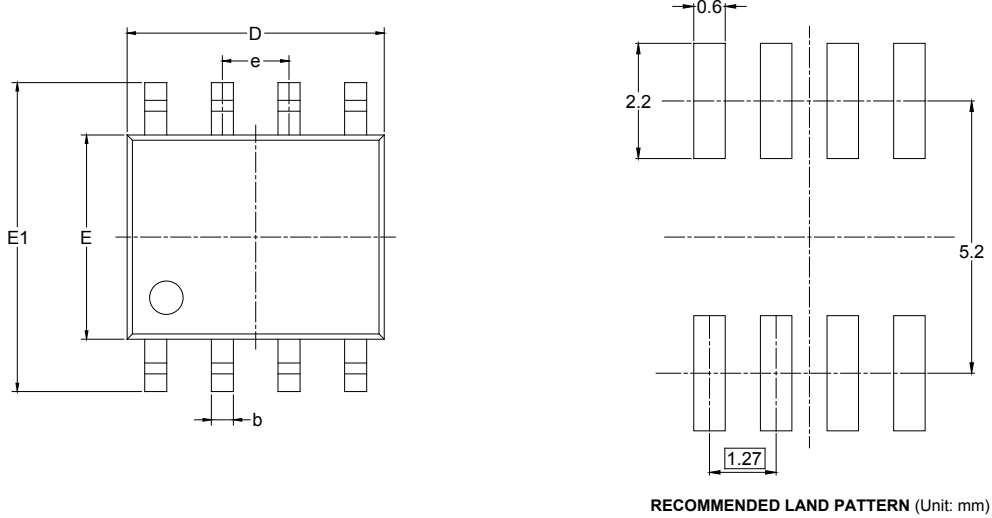

Symbol	Dimensions In Millimeters		Dimensions In Inches	
	MIN	MAX	MIN	MAX
A	1.350	1.750	0.053	0.069
A1	0.100	0.250	0.004	0.010
A2	1.350	1.550	0.053	0.061
b	0.330	0.510	0.013	0.020
c	0.170	0.250	0.006	0.010
D	4.700	5.100	0.185	0.200
E	3.800	4.000	0.150	0.157
E1	5.800	6.200	0.228	0.244
e	1.27 BSC		0.050 BSC	
L	0.400	1.270	0.016	0.050
$\theta$	0°	8°	0°	8°

PACKAGE OUTLINE DIMENSIONS

MSOP-8



RECOMMENDED LAND PATTERN (Unit: mm)

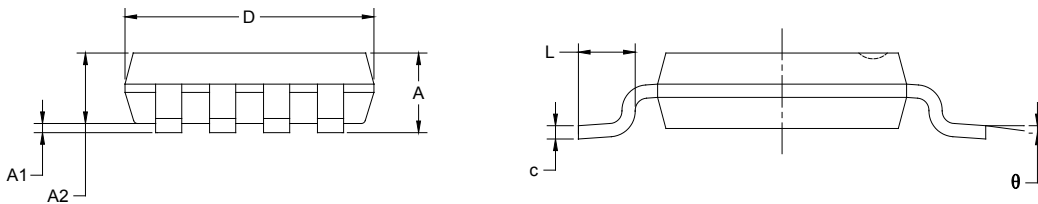

Symbol	Dimensions In Millimeters		Dimensions In Inches	
	MIN	MAX	MIN	MAX
A	0.820	1.100	0.032	0.043
A1	0.020	0.150	0.001	0.006
A2	0.750	0.950	0.030	0.037
b	0.250	0.380	0.010	0.015
c	0.090	0.230	0.004	0.009
D	2.900	3.100	0.114	0.122
E	2.900	3.100	0.114	0.122
E1	4.750	5.050	0.187	0.199
e	0.650 BSC		0.026 BSC	
L	0.400	0.800	0.016	0.031
θ	0°	6°	0°	6°

# PACKAGE INFORMATION

## PACKAGE OUTLINE DIMENSIONS

### SOIC-14

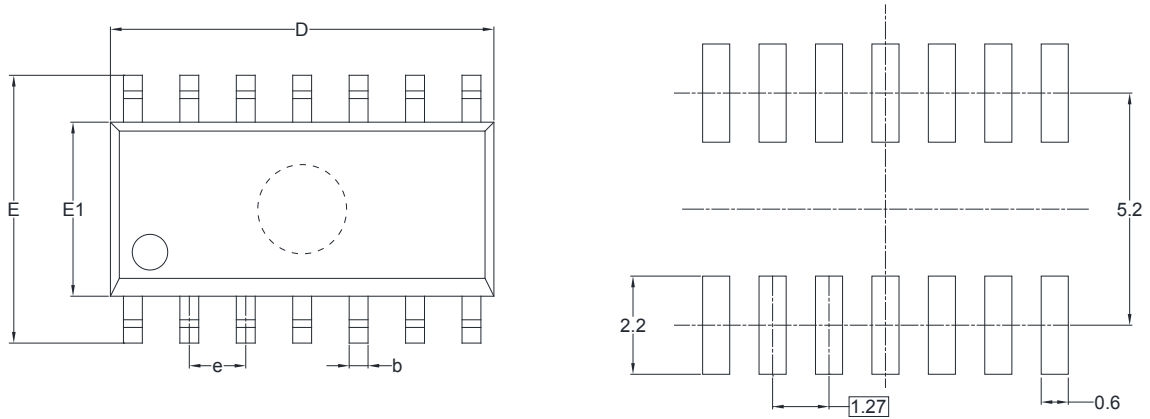

RECOMMENDED LAND PATTERN (Unit: mm)

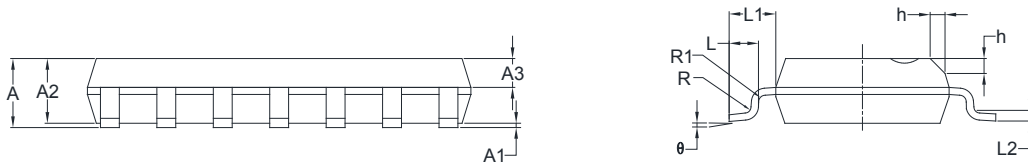

Symbol	Dimensions In Millimeters		Dimensions In Inches	
	MIN	MAX	MIN	MAX
A	1.35	1.75	0.053	0.069
A1	0.10	0.25	0.004	0.010
A2	1.25	1.65	0.049	0.065
A3	0.55	0.75	0.022	0.030
b	0.36	0.49	0.014	0.019
D	8.53	8.73	0.336	0.344
E	5.80	6.20	0.228	0.244
E1	3.80	4.00	0.150	0.157
e	1.27 BSC		0.050 BSC	
L	0.45	0.80	0.018	0.032
L1	1.04 REF		0.040 REF	
L2	0.25 BSC		0.01 BSC	
R	0.07		0.003	
R1	0.07		0.003	
h	0.30	0.50	0.012	0.020
θ	0°	8°	0°	8°

# PACKAGE INFORMATION

## PACKAGE OUTLINE DIMENSIONS

### TSSOP-14

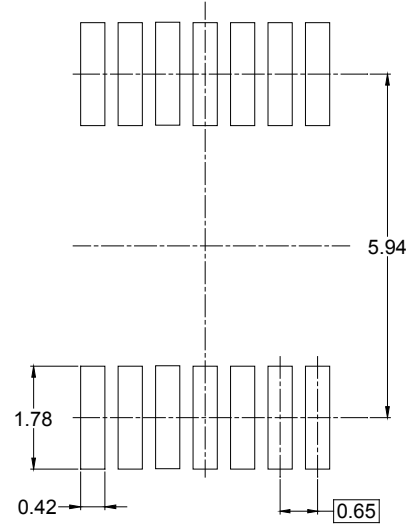
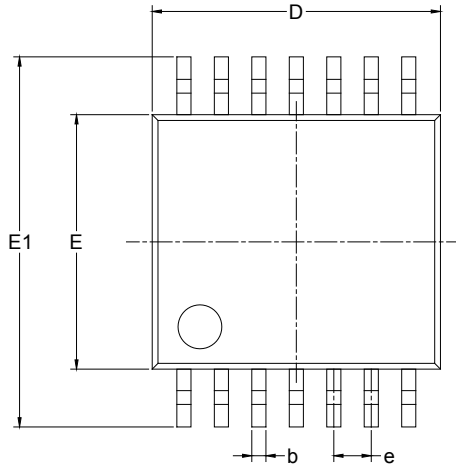

RECOMMENDED LAND PATTERN (Unit: mm)

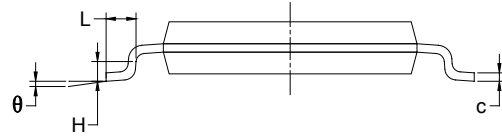
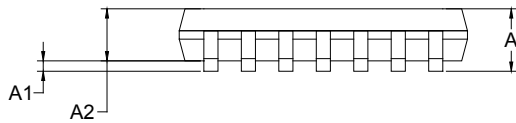

Symbol	Dimensions In Millimeters		Dimensions In Inches	
	MIN	MAX	MIN	MAX
A		1.200		0.047
A1	0.050	0.150	0.002	0.006
A2	0.800	1.050	0.031	0.041
b	0.190	0.300	0.007	0.012
c	0.090	0.200	0.004	0.008
D	4.860	5.100	0.191	0.201
E	4.300	4.500	0.169	0.177
E1	6.250	6.550	0.246	0.258
e	0.650 BSC		0.026 BSC	
L	0.500	0.700	0.02	0.028
H	0.25 TYP		0.01 TYP	
θ	1°	7°	1°	7°



# PACKAGE INFORMATION

## TAPE AND REEL INFORMATION

### REEL DIMENSIONS

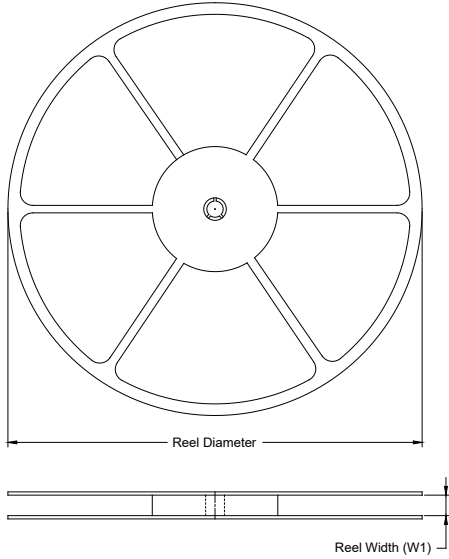

### TAPE DIMENSIONS

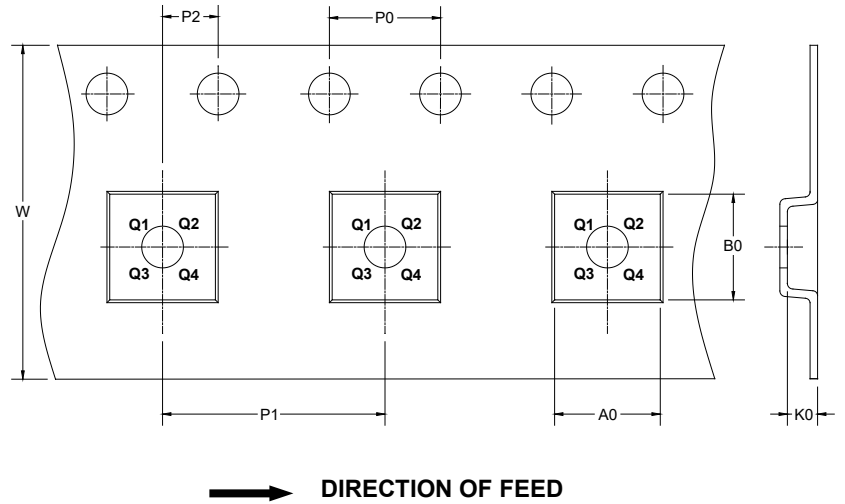

NOTE: The picture is only for reference. Please make the object as the standard.

### KEY PARAMETER LIST OF TAPE AND REEL

Package Type	Reel Diameter	Reel Width W1 (mm)	A0 (mm)	B0 (mm)	K0 (mm)	P0 (mm)	P1 (mm)	P2 (mm)	W (mm)	Pin1 Quadrant
SOT-23-5	7"	9.5	3.20	3.20	1.40	4.0	4.0	2.0	8.0	Q3
SOIC-8	13"	12.4	6.40	5.40	2.10	4.0	8.0	2.0	12.0	Q1
MSOP-8	13"	12.4	5.20	3.30	1.50	4.0	8.0	2.0	12.0	Q1
SOIC-14	13"	16.4	6.60	9.30	2.10	4.0	8.0	2.0	16.0	Q1
TSSOP-14	13"	12.4	6.95	5.60	1.20	4.0	8.0	2.0	12.0	Q1

D30001

# PACKAGE INFORMATION

## CARTON BOX DIMENSIONS



NOTE: The picture is only for reference. Please make the object as the standard.

## KEY PARAMETER LIST OF CARTON BOX

Reel Type	Length (mm)	Width (mm)	Height (mm)	Pizza/Carton
7" (Option)	368	227	224	8
7"	442	410	224	18
13"	386	280	370	5

DD0002