

SGM8752-1/SGM8752-2/SGM8752-3

6.5ns, Rail-to-Rail I/O, High Speed Comparators

GENERAL DESCRIPTION

The SGM8752-1 (single), SGM8752-2 (dual) and SGM8752-3 (single with shutdown) are high speed comparators, which feature a fast 6.5ns propagation delay. These devices are optimized for low voltage operation from 2.7V to 5.5V. The SGM8752-1/2/3 have a push-pull CMOS output stage, which supports rail-to-rail output swing. They can be compatible with CMOS and TTL logics.

The SGM8752-1/2/3 feature small packages. They are suitable for portable and space-restricted applications. The SGM8752-1 is available in a Green SOT-23-5 package. The SGM8752-2 is available in Green SOT-23-8 and SOIC-8 packages. The SGM8752-3 is available in a Green SOT-23-6 package. They are operated over the -40°C to +125°C temperature range.

FEATURES

- **High Speed: 6.5ns Propagation Delay**
- **Push-Pull CMOS Output Structure**
- **Rail-to-Rail Input and Output**
- **Supply Voltage: 2.7V to 5.5V**
- **Shutdown (SGM8752-3 Only)**
- **Low Quiescent Current: 1.8mA/Channel**
- **-40°C to +125°C Operating Temperature Range**
- **Small Packaging:**
 - SGM8752-1 Available in a Green SOT-23-5 Package**
 - SGM8752-2 Available in Green SOT-23-8 and SOIC-8 Packages**
 - SGM8752-3 Available in a Green SOT-23-6 Package**

APPLICATIONS

Window Comparators
Threshold Detectors
Zero-Crossing Detectors
Radio Base Stations
Automatic Test Equipment

PIN CONFIGURATIONS

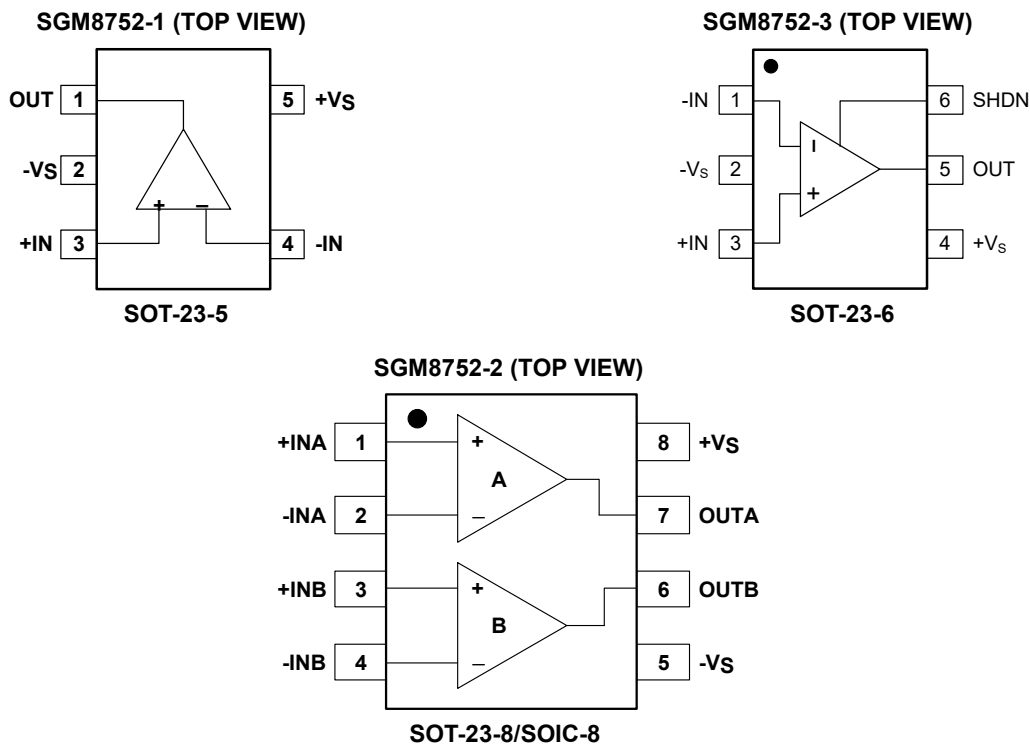

PIN DESCRIPTION

Table 1. SGM8752-1 and SGM8752-3 Pin Description

PIN		NAME	I/O	FUNCTION
SOT-23-5	SOT-23-6			
1	5	OUT	O	Output.
2	2	-Vs	—	Negative Power Supply.
3	3	+IN	I	Non-Inverting Input.
4	1	-IN	I	Inverting Input.
5	4	+Vs	—	Positive Power Supply.
—	6	SHDN	—	Shutdown (Only for SGM8752-3). If this pin is floating, the device will be in idle mode. When SHDN = "low", the part is active; When SHDN = "high", the part is in shutdown.

Table 2. SGM8752-2 Pin Description

PIN		NAME	I/O	FUNCTION
SOT-23-8/SOIC-8				
1		+INA	I	Non-Inverting Input of Channel A.
2		-INA	I	Inverting Input of Channel A.
3		+INB	I	Non-Inverting Input of Channel B
4		-INB	I	Inverting Input of Channel B.
5		-Vs	—	Negative Power Supply.
6		OUTB	O	Output of Channel B.
7		OUTA	O	Output of Channel A.
8		+Vs	—	Positive Power Supply.

ELECTRICAL CHARACTERISTICS

($V_S = 2.7V$ to $5.5V$, Full = $-40^\circ C$ to $+125^\circ C$, typical values are at $T_A = +25^\circ C$, unless otherwise noted.)

PARAMETER	SYMBOL	CONDITIONS	TEMP	MIN	TYP	MAX	UNITS
Input Characteristics							
Input Offset Voltage ⁽¹⁾	V_{OS}	$V_{CM} = 0V, I_{OUT} = 0mA$	+25°C		±1	±6.5	mV
			Full			±7	
Input Offset Voltage Drift	$\Delta V_{OS}/\Delta T$		Full		5		μV/°C
Input Hysteresis			+25°C		6		mV
Input Bias Current	I_B	$V_{CM} = V_S/2$	+25°C		±20	±250	pA
			Full			±500	
Input Offset Current	I_{OS}	$V_{CM} = V_S/2$	+25°C		±20	±250	pA
			Full			±500	
Input Common Mode Voltage Range	V_{CM}		Full	$(-V_S) - 0.2$		$(+V_S) + 0.2$	V
Common Mode Rejection Ratio	CMRR	$V_S = 5.5V,$ $V_{CM} = -0.2V$ to $(+V_S) + 0.2V$	+25°C	57	74		dB
			Full	55			
		$V_S = 2.7V,$ $V_{CM} = -0.2V$ to $(+V_S) + 0.2V$	+25°C	52	70		
			Full	50			
Input Impedance							
Differential			+25°C		$10^{12} \parallel 4$		Ω pF
Common Mode			+25°C		$10^{12} \parallel 2$		Ω pF
Output Characteristics							
Output Voltage Swing from Rail	V_{OH}, V_{OL}	$I_{OUT} = \pm 1mA$	+25°C		40	50	mV
			Full			65	
Output Short-Circuit Current	I_{OUT}	$V_S = 2.7V, R_L = 2\Omega$ to GND	+25°C	20	25		mA
			Full	15			
		$V_S = 5.5V, R_L = 2\Omega$ to GND	+25°C	60	74		
			Full	46			
Shutdown (SGM8752-3 Only)							
Shutdown Turn-Off Time	t_{OFF}		+25°C		30		ns
Shutdown Turn-On Time	t_{ON}		+25°C		100		ns
SHDN Low Threshold	V_{IL}	Comparator is enabled ⁽²⁾	Full			$(+V_S) - 1.8$	V
SHDN High Threshold	V_{IH}	Comparator is disabled ⁽²⁾	Full	$(+V_S) - 0.9$			V
SHDN Input Bias Current			Full		0.01	1	μA
Shutdown Quiescent Current	$I_{Q(SHDN)}$		Full		0.1	1	μA
Power Supply							
Operating Voltage Range	V_S		Full	2.7		5.5	V
Quiescent Current/Channel	I_Q	$V_S = 5V, V_{OUT} = High$	+25°C		1.8	2.3	mA
			Full			3.2	
Power Supply Rejection Ratio	PSRR	$V_S = 2.7V$ to $5.5V$	+25°C		100	450	μV/V
			Full			650	

NOTES:

- V_{OS} is the differential voltage which can make the output of the comparator equals to 0V.
- If the voltage of SHDN pin is larger than $(+V_S) - 0.9V$, the device will disable. If the voltage of SHDN pin is less than $(+V_S) - 1.8V$, the device will operate.

SWITCHING CHARACTERISTICS

($V_S = 2.7V$ to $5.5V$, Full = $-40^\circ C$ to $+125^\circ C$, typical values are at $T_A = +25^\circ C$, unless otherwise noted.)

PARAMETER	SYMBOL	CONDITIONS	TEMP	MIN	TYP	MAX	UNITS
Propagation Delay Time ⁽¹⁾⁽²⁾	t_{PD}	$\Delta V_{IN} = 100mV$, overdrive = 20mV	Full		6.5	9	ns
		$\Delta V_{IN} = 100mV$, overdrive = 5mV	Full		8.5	13	
Propagation Delay Skew ⁽³⁾	Δt_{SK}	$\Delta V_{IN} = 100mV$, overdrive = 20mV	+25°C		1.3		ns
Maximum Toggle Frequency	f_{MAX}	$V_S = 5V$, overdrive = 50mV	+25°C		60		MHz
Rise Time ⁽⁴⁾	t_R		+25°C		1.2		ns
Fall Time ⁽⁴⁾	t_F		+25°C		0.9		ns

NOTES:

1. Specified by design and characterization; not production tested.
2. For low overdrive voltages, the propagation delay measured during production testing is not accurate. This parameter is derived from data measured with a 100mV overdrive voltage.
3. The propagation delay skew is defined as the time difference between propagation delay going high and going low.
4. The rise time is measured between 10% and 90% of the full scale voltage.

TYPICAL PERFORMANCE CHARACTERISTICS

At $T_A = +25^\circ\text{C}$, $V_S = 5\text{V}$ and Overdrive = 100mV, unless otherwise noted.

Output Response for Various Overdrive Voltages (L-H)

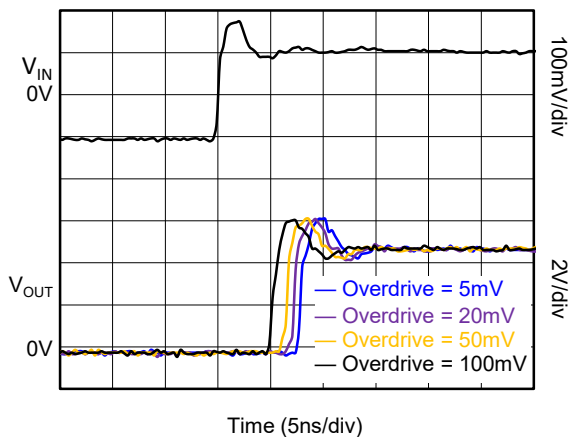

Output Response for Various Overdrive Voltages (H-L)

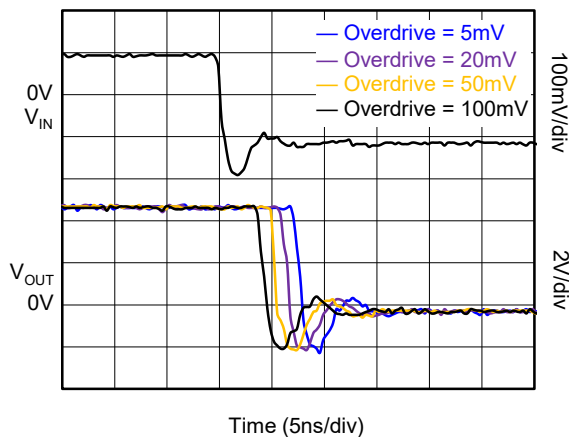

Response to 50MHz Sine Wave

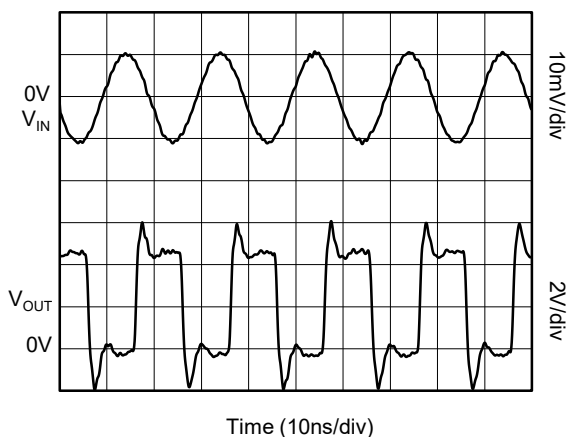

Response to 100MHz Square Wave



Propagation Delay vs. Temperature

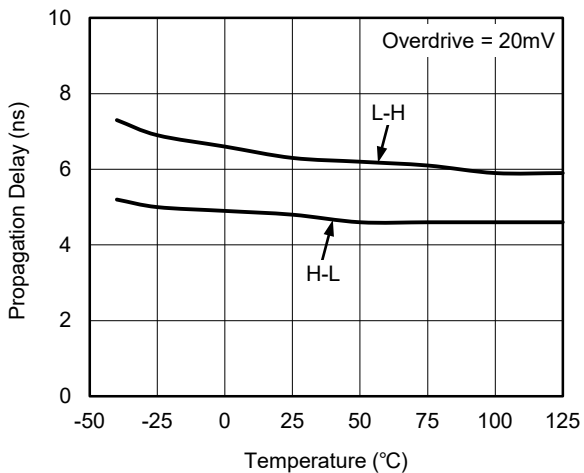

Propagation Delay vs. Temperature

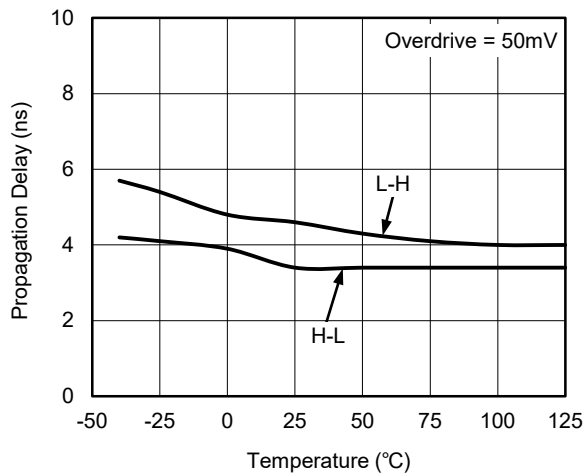

TYPICAL PERFORMANCE CHARACTERISTICS (continued)

At $T_A = +25^\circ\text{C}$, $V_S = 5\text{V}$ and Overdrive = 100mV, unless otherwise noted.

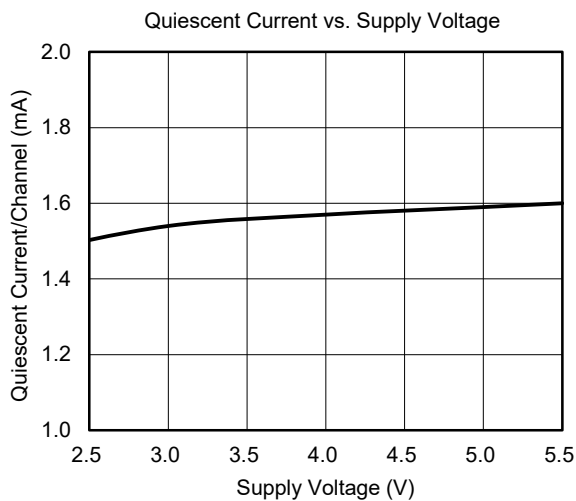
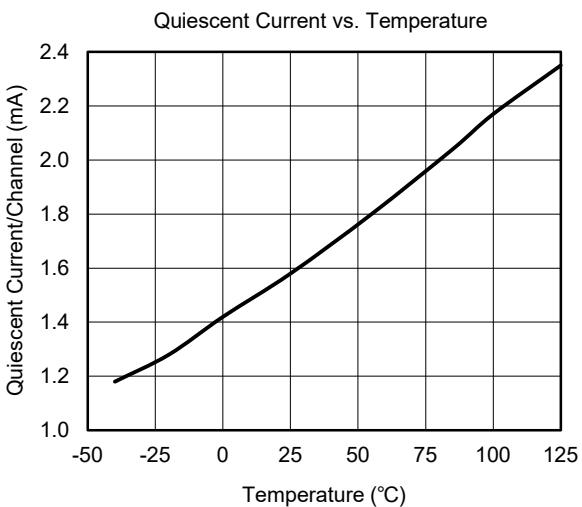
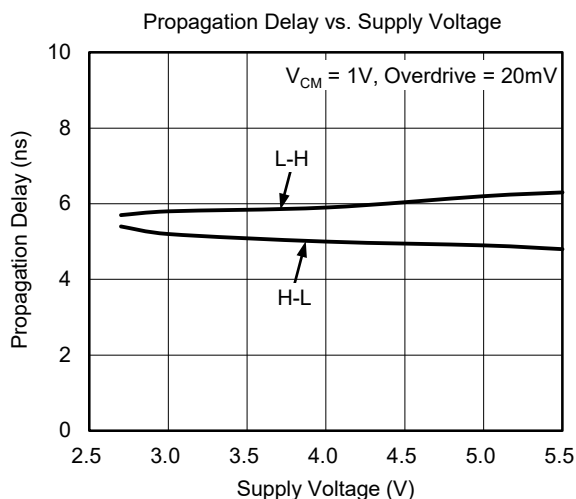
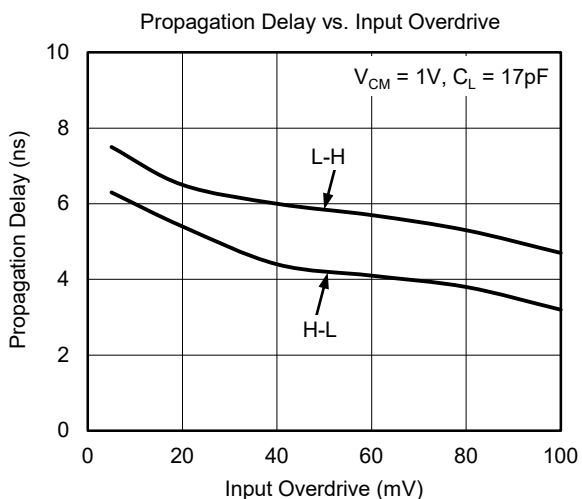
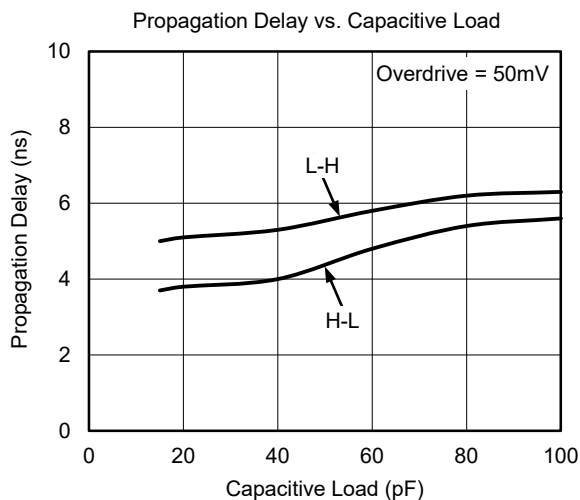
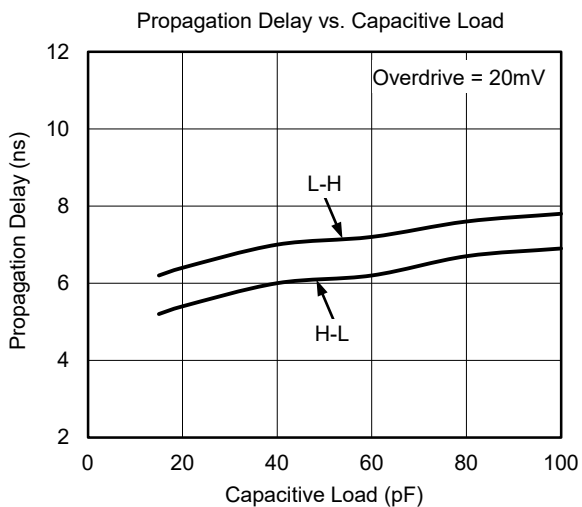

TYPICAL PERFORMANCE CHARACTERISTICS (continued)

At $T_A = +25^\circ\text{C}$, $V_S = 5\text{V}$ and Overdrive = 100mV, unless otherwise noted.

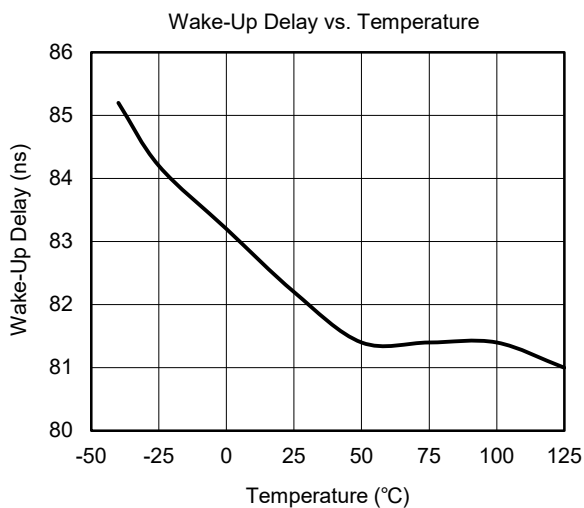
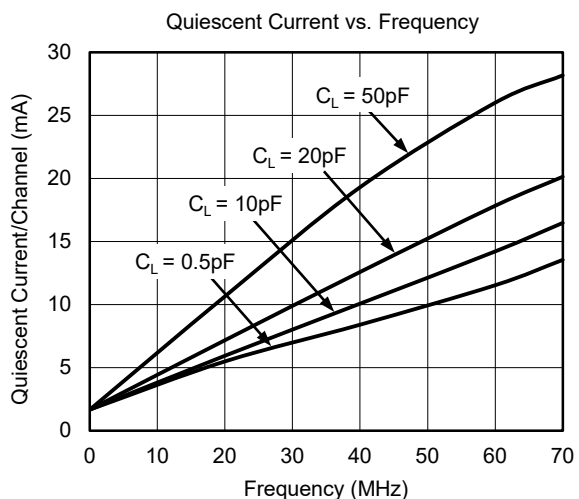
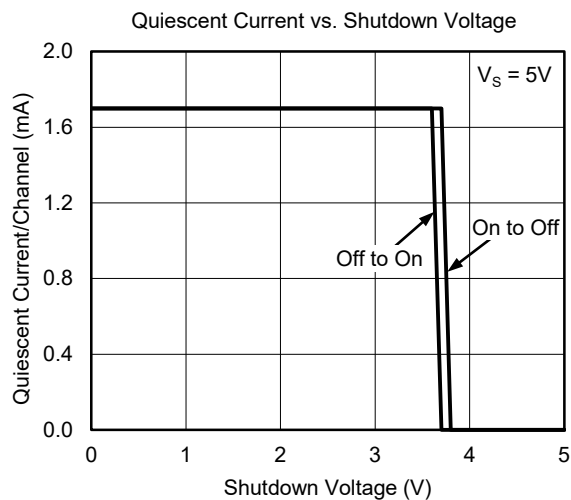
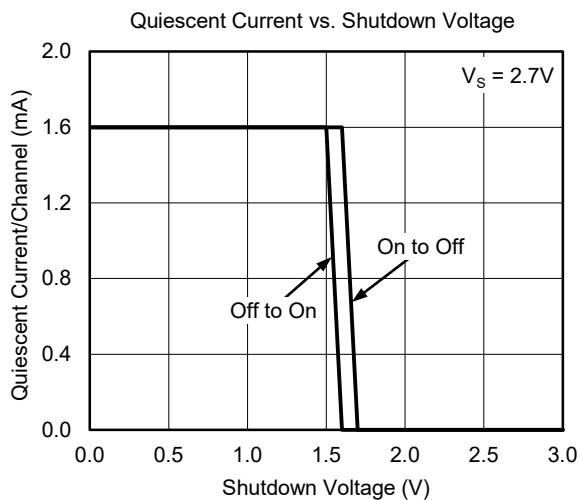

FUNCTIONAL BLOCK DIAGRAM

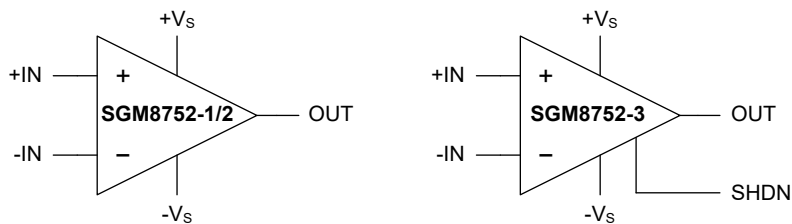

Figure 1. Block Diagram

DETAILED DESCRIPTION

The SGM8752-1/2/3 are comparators with extreme high speed and 6mV hysteresis, which helps to improve the noise immunity. The common mode range extends 0.2V beyond the power supply voltage rails.

Operating Voltage

The SGM8752-1/2/3 can operate from 2.7V to 5.5V single supply or from $\pm 1.35V$ to $\pm 2.75V$ dual supplies over the $-40^{\circ}C$ to $+125^{\circ}C$ temperature range.

Input Over-Voltage Protection

In the internal of SGM8752-1/2/3, ESD diodes are used to protect these devices from higher voltages (300mV greater than the supply voltage). However, adding a resistor at the input of the comparator is a good choice to absorb the momentary voltage which is greater than 300mV by limiting the current within 10mA.

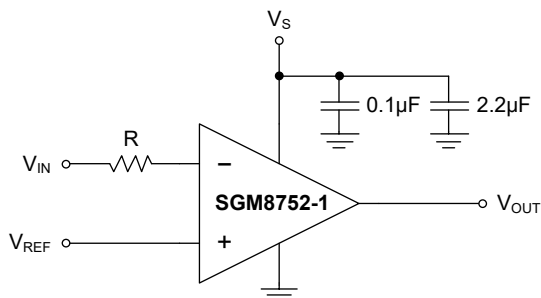

Figure 2. Current Limit by Adding a Resistor

Shutdown

The idle mode can be launched by the shutdown pin. If there is a high-level voltage added at the shutdown pin, the operating current is 0.1µA and the output impedance is significantly high. On the other hand, if a low-level voltage is presented at the shutdown pin, the comparator will be operational and the output impedance is low. It is recommended to connect the shutdown pin to $-V_S$ if the shutdown feature is not used. And, it will take 100ns to active the device if exiting the shutdown mode. For Figure 3, the SGM8752-3 is the only one with shutdown control.

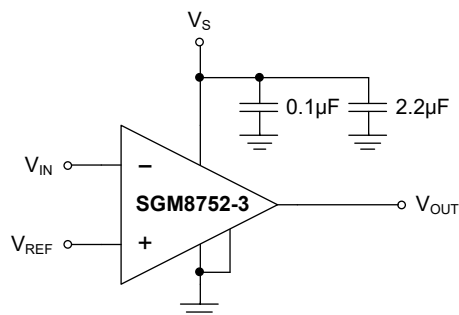

Figure 3. Recommended Connections for the SGM8752-3

APPLICATION INFORMATION

Adding External Hysteresis

The effect of significant input noise is an issue that has to be taken into consideration for applications with slow moving or noisy input signals. The output will switch as the result of the input noise, although there is 6mV internal hysteresis. For this case, it is recommended to add external resistors at the positive terminal of the comparator. For the circuit which is shown in Figure 4, the external 25mV hysteresis is added so the total hysteresis is 31mV, which will improve the noise immunity. The equation shown as below is used to calculate the total supported hysteresis of the circuit.

$$V_{HYST} = \frac{(+V_S) \times R_1}{R_1 + R_2} + 6mV \quad (1)$$

V_{HYST} is the required transition voltage range for switching these devices; therefore, the noise immunity is improved.

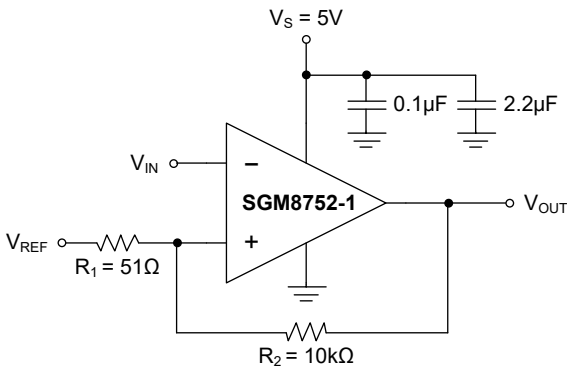

Figure 4. Adding Hysteresis to the SGM8752-1

Relaxation Oscillator

A relaxation oscillator can be made by SGM8752-1/2/3 due to their high speed property. For the following circuit, the R_2 network with the same resistance sets two trip points which are $1/3V_S$ and $2/3V_S$. The resistance of R_2 network should be small enough to reject the effect of parasitic capacitance as the operation of SGM8752-1/2/3 is high speed. The $1/3V_S$ and $2/3V_S$ are the two thresholds of the input signal, which can switch the output of the signal. Also, after calculation, the sum of charging and discharging period is $2\ln 2 \times R_1C$. With the application which is shown as below, the calculated oscillated frequency is equal to 10.9MHz. However, because of the parasitic capacitance, the theoretical frequency is around 9.6MHz.

Design Requirements

For the R_2 network, the users must set values of three resistors equally to ensure that the two trip points are equal to $1/3V_S$ and $2/3V_S$. Also, the resistance of R_2 network should be small enough to reject the effect of parasitic capacitance. In addition, there are two requirements for the value of R_1 , which are drawing less current and providing high switching frequency. On top of this, higher capacitance for the capacitor is required for improving the error which is caused by the tolerance and parasitic capacitance.

Detailed Design Procedure

For the application, the positive input, $+V_{IN}$ is equal to the $1/3V_S$ if the V_{OL} is close to GND. And $+V_{IN}$ is equal to $2/3V_S$ if the V_{OH} is close to V_S .

The charging and discharging periods at the negative input and which are reflected at V_C , are the same, and the value of charging and discharging period is equal to R_1C .

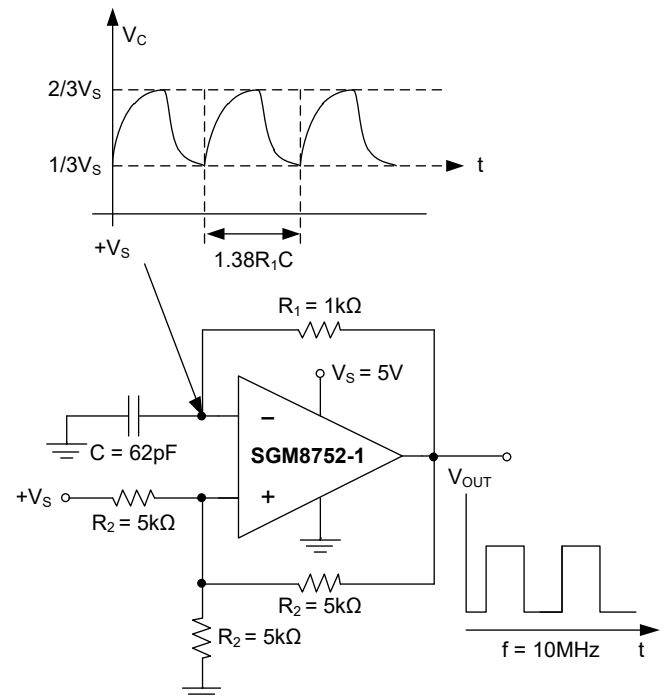

Figure 5. Relaxation Oscillator

APPLICATION INFORMATION (continued)

High Speed Window Comparator

The output of the window comparator will switch if the input of the circuit reaches its V_{OL} or V_{OH} . Because SGM8752-1/2/3 are high speed comparators, it is excellent to use these devices for the designing of a high speed window comparator, with two thresholds V_{HI} and V_{LO} . If the voltage level of V_{IN} is between the two thresholds of the circuit, the output of the circuit will be in high position. For the application of active low which is shown in Figure 7, the position of V_{HI} and V_{LO} is different from the application in Figure 6. On top of this, the supported voltage ranges for both of the applications are from 2.7V to 5.5V.

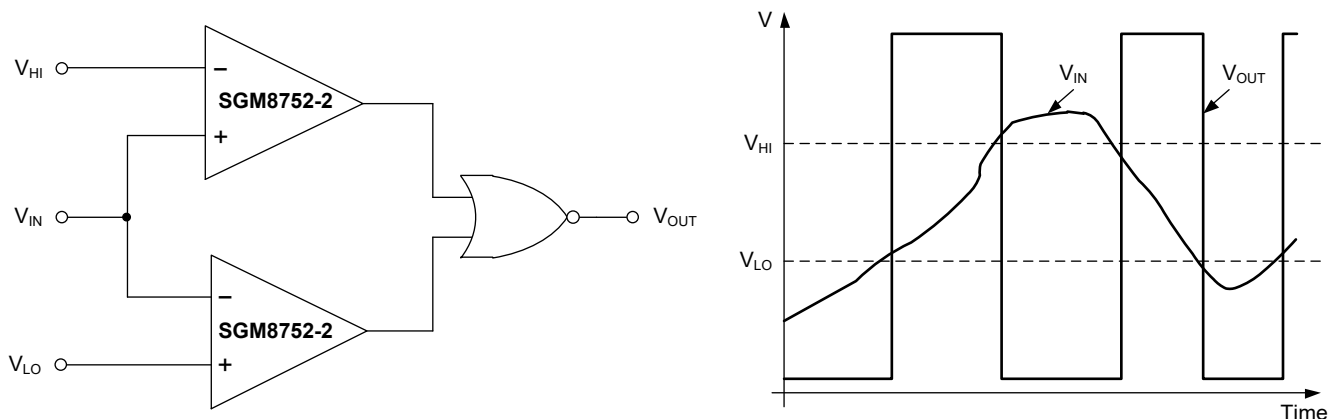

Figure 6. Window Comparator - Active High

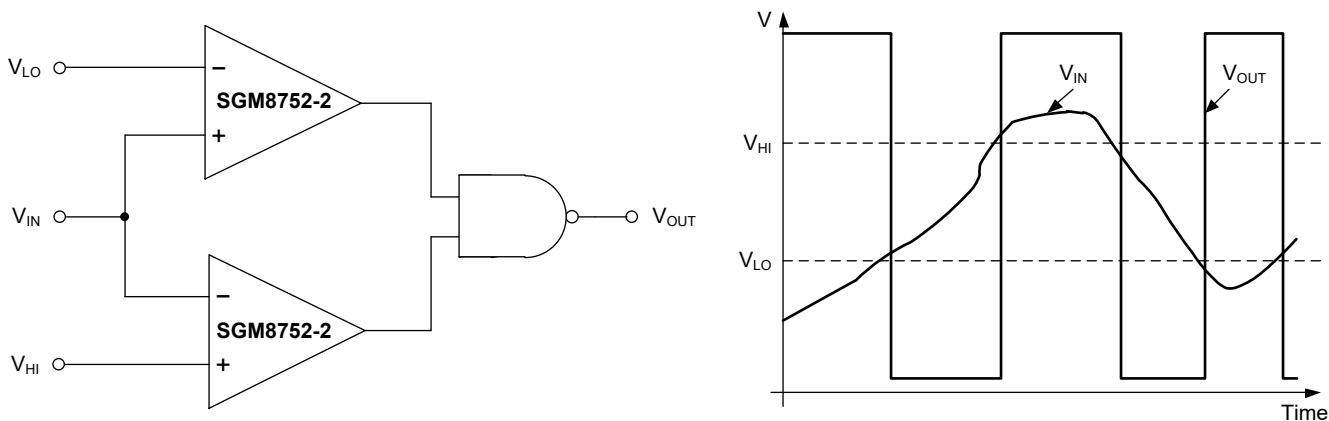

Figure 7. Window Comparator - Active Low

APPLICATION INFORMATION (continued)

Power Supply Recommendations

The SGM8752-1/2/3 can be used for both single and dual power supply modes with the temperature from -40°C to +125°C. For the noisy or high impedance power supply condition, a bypass capacitor should be added closed to the power supply pin to enhance the stability. The section of Layout illustrates how to place the bypass capacitor.

Layout

An excellent design for PCB layout is necessary for high speed devices. Any stray capacitance or improper grounding will influence the performance of the high speed comparator.

In order to minimize the propagation delay, the users should make sure that the resistance of the signal source is as low as possible. The resistance from the input signal and the stray capacitance can create an RC filter, which can decrease the amplitude for high-frequency component. In addition, the input

capacitance and the stray capacitance result in several pF capacitances.

The paralleled 2.2 μ F and 0.1 μ F ceramic capacitors need to be placed as close to the device. The 2.2 μ F capacitor is used to enhance the stability by rejecting the ripple, and 0.1 μ F capacitor provides a charge for high-frequency component.

For high speed applications, the rising or falling edge of the signal will cause a potential DC voltage shift. For minimizing this negative influence, a plane of GND should be taken into account as it can reduce the effect of stray capacitance. Also, the ground plane can provide multiple paths for the current flow. In addition, for the high speed signal, the current will flow back at GND plane under its previous signal path. Any hole and via can increase the inductance which can reduce the performance of the high speed transmission. If vias are necessary at the ground plane, please place them randomly.

PACKAGE INFORMATION

PACKAGE OUTLINE DIMENSIONS

SOT-23-5

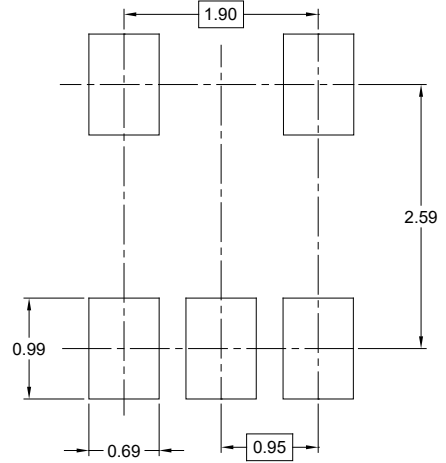
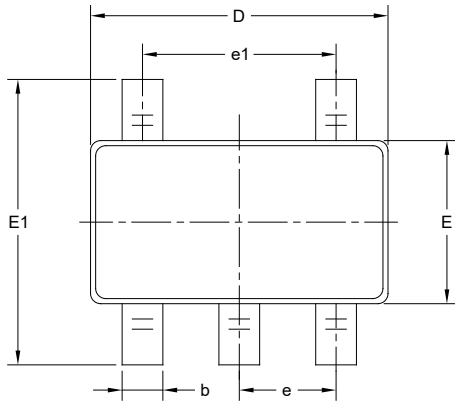

RECOMMENDED LAND PATTERN (Unit: mm)

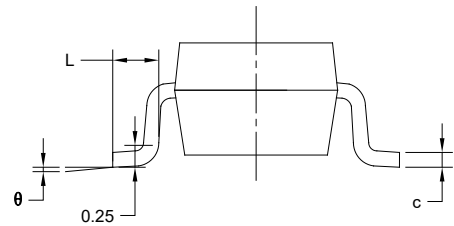
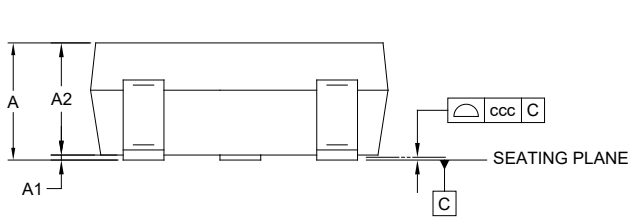

Symbol	Dimensions In Millimeters		
	MIN	MOD	MAX
A	-	-	1.450
A1	0.000	-	0.150
A2	0.900	-	1.300
b	0.300	-	0.500
c	0.080	-	0.220
D	2.750	-	3.050
E	1.450	-	1.750
E1	2.600	-	3.000
e	0.950 BSC		
e1	1.900 BSC		
L	0.300	-	0.600
θ	0°	-	8°
ccc	0.100		

NOTES:

1. This drawing is subject to change without notice.
2. The dimensions do not include mold flashes, protrusions or gate burrs.
3. Reference JEDEC MO-178.

PACKAGE INFORMATION

PACKAGE OUTLINE DIMENSIONS

SOT-23-6

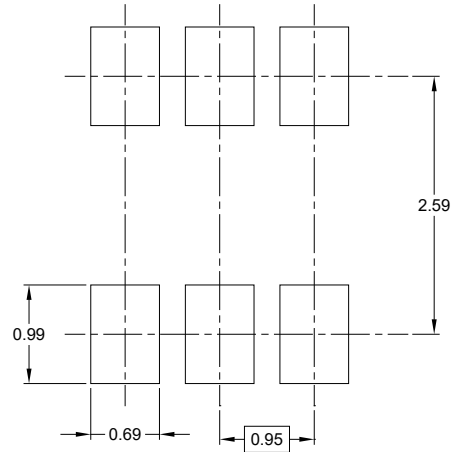
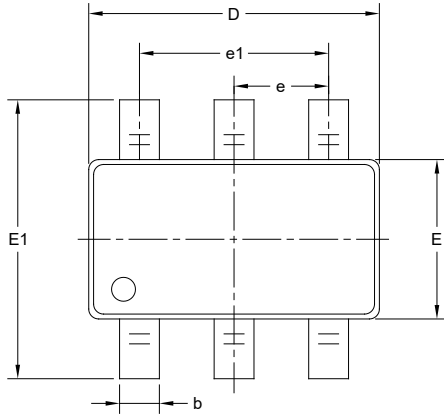

RECOMMENDED LAND PATTERN (Unit: mm)

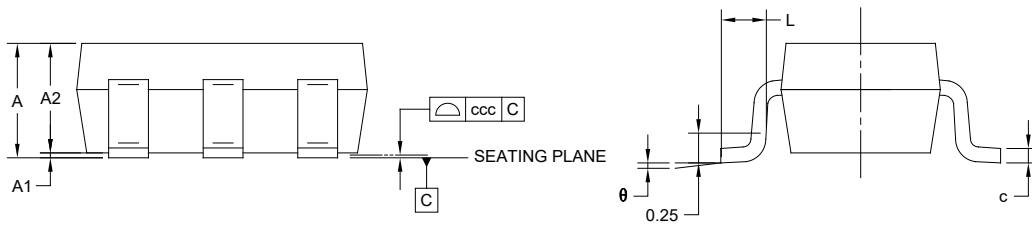

Symbol	Dimensions In Millimeters		
	MIN	MOD	MAX
A	-	-	1.450
A1	0.000	-	0.150
A2	0.900	-	1.300
b	0.300	-	0.500
c	0.080	-	0.220
D	2.750	-	3.050
E	1.450	-	1.750
E1	2.600	-	3.000
e	0.950 BSC		
e1	1.900 BSC		
L	0.300	-	0.600
θ	0°	-	8°
ccc	0.100		

NOTES:

1. This drawing is subject to change without notice.
2. The dimensions do not include mold flashes, protrusions or gate burrs.
3. Reference JEDEC MO-178.

PACKAGE INFORMATION

PACKAGE OUTLINE DIMENSIONS

SOT-23-8

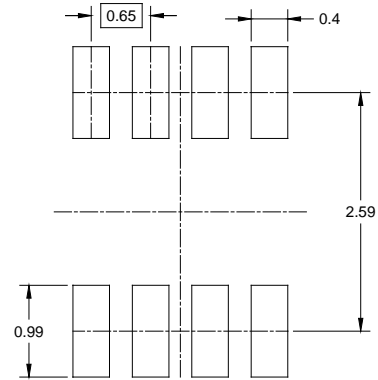
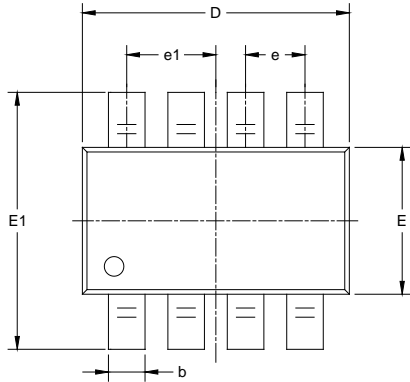

RECOMMENDED LAND PATTERN (Unit: mm)

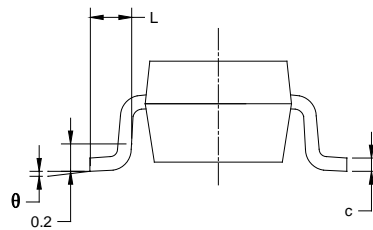
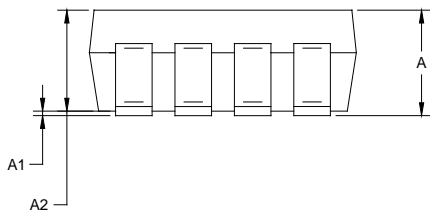

Symbol	Dimensions In Millimeters		Dimensions In Inches	
	MIN	MAX	MIN	MAX
A	1.050	1.250	0.041	0.049
A1	0.000	0.100	0.000	0.004
A2	1.050	1.150	0.041	0.045
b	0.300	0.500	0.012	0.020
c	0.100	0.200	0.004	0.008
D	2.820	3.020	0.111	0.119
E	1.500	1.700	0.059	0.067
E1	2.650	2.950	0.104	0.116
e	0.650 BSC		0.026 BSC	
e1	0.975 BSC		0.038 BSC	
L	0.300	0.600	0.012	0.024
θ	0°	8°	0°	8°

NOTES:

1. Body dimensions do not include mode flash or protrusion.
2. This drawing is subject to change without notice.

PACKAGE INFORMATION

PACKAGE OUTLINE DIMENSIONS

SOIC-8

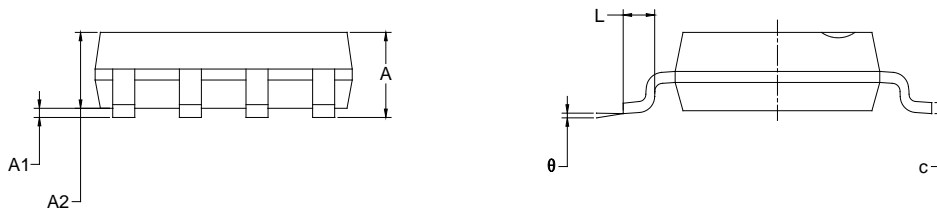
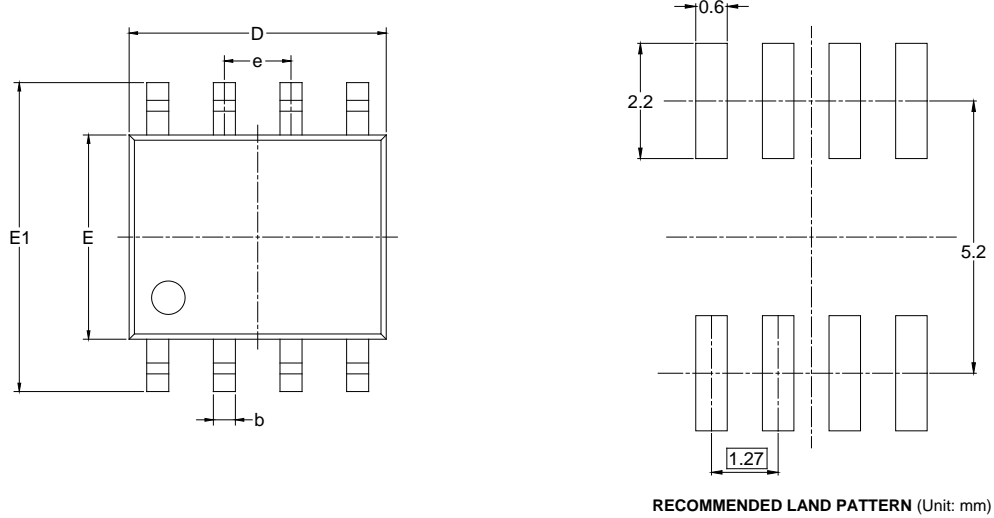

Symbol	Dimensions In Millimeters		Dimensions In Inches	
	MIN	MAX	MIN	MAX
A	1.350	1.750	0.053	0.069
A1	0.100	0.250	0.004	0.010
A2	1.350	1.550	0.053	0.061
b	0.330	0.510	0.013	0.020
c	0.170	0.250	0.006	0.010
D	4.700	5.100	0.185	0.200
E	3.800	4.000	0.150	0.157
E1	5.800	6.200	0.228	0.244
e	1.27 BSC		0.050 BSC	
L	0.400	1.270	0.016	0.050
θ	0°	8°	0°	8°

NOTES:

1. Body dimensions do not include mode flash or protrusion.
2. This drawing is subject to change without notice.

PACKAGE INFORMATION

TAPE AND REEL INFORMATION

REEL DIMENSIONS



TAPE DIMENSIONS



NOTE: The picture is only for reference. Please make the object as the standard.

KEY PARAMETER LIST OF TAPE AND REEL

Package Type	Reel Diameter	Reel Width W1 (mm)	A0 (mm)	B0 (mm)	K0 (mm)	P0 (mm)	P1 (mm)	P2 (mm)	W (mm)	Pin1 Quadrant
SOT-23-5	7"	9.5	3.20	3.20	1.40	4.0	4.0	2.0	8.0	Q3
SOT-23-6	7"	9.5	3.17	3.23	1.37	4.0	4.0	2.0	8.0	Q3
SOT-23-8	7"	9.5	3.17	3.23	1.37	4.0	4.0	2.0	8.0	Q3
SOIC-8	13"	12.4	6.40	5.40	2.10	4.0	8.0	2.0	12.0	Q1

DD0001

PACKAGE INFORMATION

CARTON BOX DIMENSIONS



NOTE: The picture is only for reference. Please make the object as the standard.

KEY PARAMETER LIST OF CARTON BOX

Reel Type	Length (mm)	Width (mm)	Height (mm)	Pizza/Carton
7" (Option)	368	227	224	8
7"	442	410	224	18
13"	386	280	370	5

DD0002