



SGM2232xQ

150mA, High Voltage, Ultra-Low I_Q , High PSRR, Low Dropout Regulator

GENERAL DESCRIPTION

The SGM2232xQ is a high voltage, ultra-low quiescent current, high PSRR and low dropout voltage linear regulator. It is capable of supplying 150mA output current with typical dropout voltage of 635mV. The operating input voltage range is from 4V to 40V and output voltages are 2.5V, 3.3V and 5.0V.

Other features include under-voltage lockout, short-circuit current limit and thermal shutdown protection. The SGM2232xQ is suitable for various automotive applications.

This device is AEC-Q100 qualified (Automotive Electronics Council (AEC) standard Q100 Grade 1) and it is suitable for automotive applications.

The SGM2232xQ is available in Green SOT-223-3 and SOT-23-5 packages. It operates over an operating temperature range of -40°C to $+125^{\circ}\text{C}$.

FEATURES

- **AEC-Q100 Qualified for Automotive Applications Device Temperature Grade 1**
 $T_A = -40^{\circ}\text{C}$ to $+125^{\circ}\text{C}$
- **Operating Input Voltage Range: 4V to 40V**
- **Fixed Outputs of 2.5V, 3.3V, 5.0V**
- **150mA Output Current**
- **Low Quiescent Current: 15 μA (TYP)**
- **Low Dropout Voltage:**
405mV (TYP) at 100mA, $V_{\text{OUT}} = 5.0\text{V}$
- **High PSRR: 78dB (TYP) at 1kHz**
- **Current Limiting and Thermal Protection**
- **Stable with Low ESR Ceramic Capacitors**
- **Under-Voltage Lockout (UVLO)**
- **-40°C to $+125^{\circ}\text{C}$ Operating Temperature Range**
- **Available in Green SOT-223-3 and SOT-23-5 Packages**

APPLICATIONS

Automotive Applications

TYPICAL APPLICATION

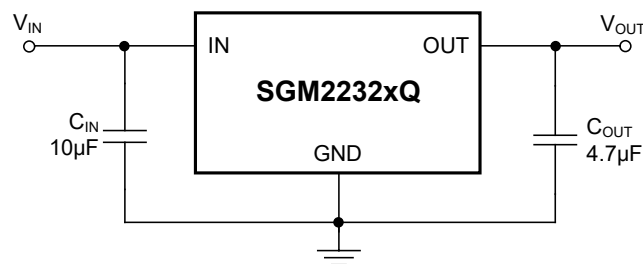

Figure 1. Typical Application Circuit

PACKAGE/ORDERING INFORMATION

MODEL	PACKAGE DESCRIPTION	SPECIFIED TEMPERATURE RANGE	ORDERING NUMBER	PACKAGE MARKING	PACKING OPTION
SGM2232-2.5Q	SOT-223-3	-40°C to +125°C	SGM2232-2.5QKC3G/TR	0IQ XXXXXX	Tape and Reel, 2500
SGM2232-3.3Q	SOT-223-3	-40°C to +125°C	SGM2232-3.3QKC3G/TR	0MZ XXXXXX	Tape and Reel, 2500
SGM2232-5.0Q	SOT-223-3	-40°C to +125°C	SGM2232-5.0QKC3G/TR	0IP XXXXXX	Tape and Reel, 2500
SGM2232-2.5Q	SOT-23-5	-40°C to +125°C	SGM2232-2.5QN5G/TR	0INXX	Tape and Reel, 3000
SGM2232-3.3Q	SOT-23-5	-40°C to +125°C	SGM2232-3.3QN5G/TR	0IOXX	Tape and Reel, 3000
SGM2232-5.0Q	SOT-23-5	-40°C to +125°C	SGM2232-5.0QN5G/TR	0IMXX	Tape and Reel, 3000

MARKING INFORMATION

NOTE: XXXXX = Date Code, Trace Code and Vendor Code. XX = Date Code.

SOT-223-3

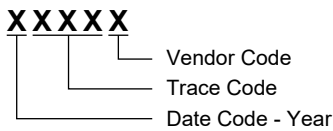

SOT-23-5

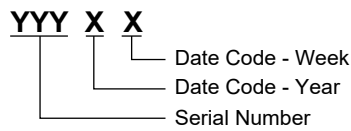

Green (RoHS & HSF): SG Micro Corp defines "Green" to mean Pb-Free (RoHS compatible) and free of halogen substances. If you have additional comments or questions, please contact your SGMICRO representative directly.

ABSOLUTE MAXIMUM RATINGS

- IN to GND -0.3V to 45V
- OUT to GND -0.3V to 7V
- Package Thermal Resistance
- SOT-223-3, θ_{JA} 57.7°C/W
- SOT-223-3, θ_{JB} 10.4°C/W
- SOT-223-3, θ_{JC} 32.6°C/W
- SOT-23-5, θ_{JA} 164.1°C/W
- SOT-23-5, θ_{JB} 28.6°C/W
- SOT-23-5, θ_{JC} 51.8°C/W
- Junction Temperature +150°C
- Storage Temperature Range -65°C to +150°C
- Lead Temperature (Soldering, 10s) +260°C

RECOMMENDED OPERATING CONDITIONS

- Input Voltage Range 4V to 40V
- Input Effective Capacitance, C_{IN} 2.2µF (MIN)
- Output Effective Capacitance, C_{OUT} 2.2µF to 100µF
- Operating Junction Temperature Range -40°C to +150°C

OVERSTRESS CAUTION

Stresses beyond those listed in Absolute Maximum Ratings may cause permanent damage to the device. Exposure to absolute maximum rating conditions for extended periods may affect reliability. Functional operation of the device at any conditions beyond those indicated in the Recommended Operating Conditions section is not implied.

ESD SENSITIVITY CAUTION

This integrated circuit can be damaged if ESD protections are not considered carefully. SGMICRO recommends that all integrated circuits be handled with appropriate precautions. Failure to observe proper handling and installation procedures can cause damage. ESD damage can range from subtle performance degradation to complete device failure. Precision integrated circuits may be more susceptible to damage because even small parametric changes could cause the device not to meet the published specifications.

DISCLAIMER

SG Micro Corp reserves the right to make any change in circuit design, or specifications without prior notice.

PIN CONFIGURATIONS

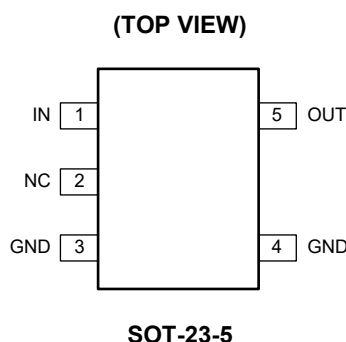
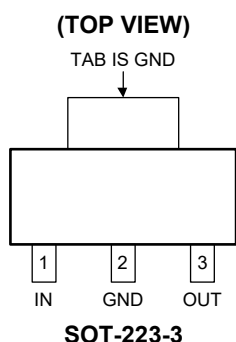

PIN DESCRIPTION

PIN		NAME	FUNCTION
SOT-223-3	SOT-23-5		
1	1	IN	Input Supply Voltage Pin. It is recommended to use a 10μF or larger ceramic capacitor from IN pin to ground. This ceramic capacitor should be placed as close as possible to the IN pin.
2, TAB	3, 4	GND	Ground.
3	5	OUT	Regulator Output Pin. It is recommended to use a ceramic capacitor with effective capacitance in the range of 2.2μF to 100μF. This ceramic capacitor should be placed as close as possible to the OUT pin.
—	2	NC	No Connection.

ELECTRICAL CHARACTERISTICS

(V_{IN} = V_{OUT(NOM)} + 1.5V, C_{IN} = 10μF, C_{OUT} = 4.7μF, T_J = -40°C to +150°C, typical values are at T_J = +25°C, unless otherwise noted.)

PARAMETER	SYMBOL	CONDITIONS		MIN	TYP	MAX	UNITS
Input Voltage Range	V _{IN}	V _{OUT(NOM)} = 2.5V		4		40	V
		V _{OUT(NOM)} = 3.3V		4		40	
		V _{OUT(NOM)} = 5.0V		5.5		40	
Output Voltage Accuracy	V _{OUT}	I _{OUT} = 1mA to 150mA		TBD		TBD	%
Under-Voltage Lockout Thresholds	V _{UVLO}	V _{IN} rising			2.12		V
		V _{IN} falling			1.91		
Line Regulation	ΔV _{LNR}	V _{IN} = (V _{OUT(NOM)} + 1.5V) to 40V, I _{OUT} = 1mA			1		mV
Load Regulation	ΔV _{LDR}	I _{OUT} = 1mA to 150mA			10		mV
Dropout Voltage ⁽¹⁾	V _{DROP}	I _{OUT} = 50mA	V _{OUT(NOM)} = 2.5V		230		mV
			V _{OUT(NOM)} = 3.3V		220		
			V _{OUT(NOM)} = 5.0V		195		
		I _{OUT} = 100mA	V _{OUT(NOM)} = 2.5V		460		
			V _{OUT(NOM)} = 3.3V		440		
			V _{OUT(NOM)} = 5.0V		405		
		I _{OUT} = 150mA	V _{OUT(NOM)} = 2.5V		600		
			V _{OUT(NOM)} = 3.3V		550		
			V _{OUT(NOM)} = 5.0V		635		
Output Current Limit	I _{LIMIT}	V _{OUT} = 90% × V _{OUT(NOM)}			350		mA
Short-Circuit Current Limit	I _{SHORT}	V _{OUT} = 0V			280		mA
Quiescent Current	I _Q	I _{OUT} = 0mA			15		μA
Turn-On Time	t _{ON}	From V _{IN} rising from 0V to V _{IN} to 90% × V _{OUT(NOM)}			180		μs
Power Supply Ripple Rejection	PSRR	ΔV _{RIPPLE} = 0.5V _{P-P} , V _{IN} = 14V, I _{OUT} = 10mA	f = 100Hz		78		dB
			f = 1kHz		78		
			f = 100kHz		57		
			f = 1MHz		64		
Thermal Shutdown Temperature	T _{SHDN}				180		°C
Thermal Shutdown Hysteresis	ΔT _{SHDN}				32		°C

NOTE:

1. The dropout voltage is defined as the difference between V_{IN} and V_{OUT} when V_{OUT} falls to 95% × V_{OUT(NOM)}.

FUNCTIONAL BLOCK DIAGRAM

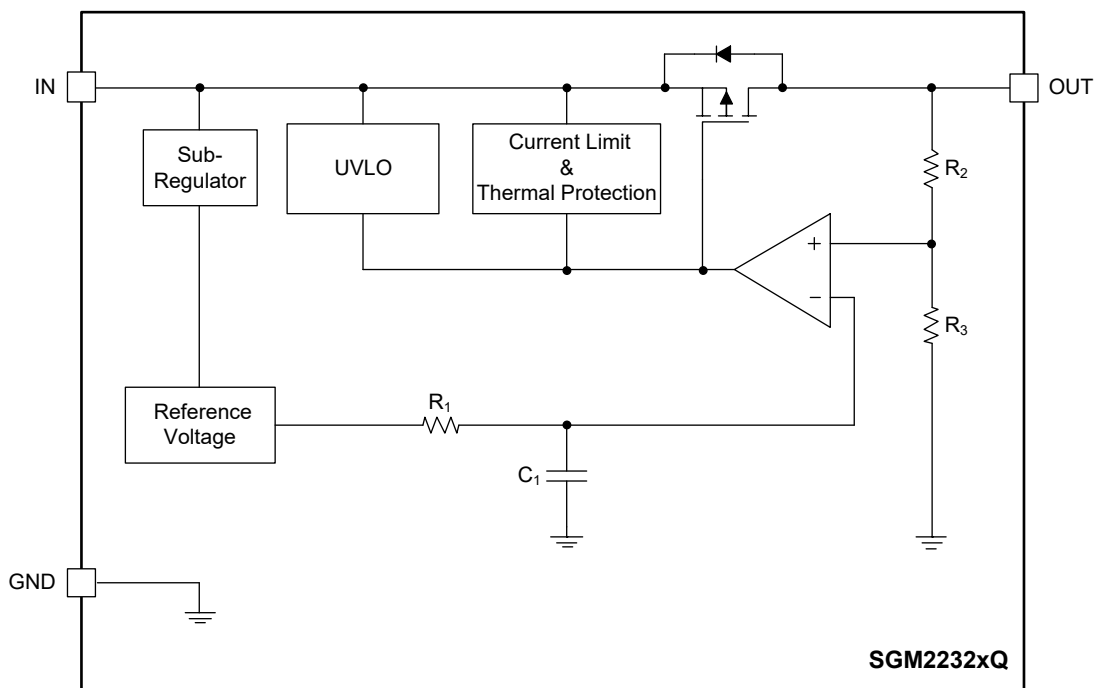

Figure 2. Block Diagram

APPLICATION INFORMATION

The SGM2232xQ is a high voltage, ultra-low quiescent current, high PSRR and low dropout LDO and provides 150mA output current. These features make the device useful in a variety of applications. The SGM2232xQ provides protection functions for output overload, output short-circuit condition and overheating.

Input Capacitor Selection (C_{IN})

The input decoupling capacitor should be placed as close as possible to the IN pin to ensure the device stability. 10μF or larger X7R or X5R ceramic capacitor is selected to get good dynamic performance.

When V_{IN} is required to provide large current instantaneously, a large effective input capacitor is required. Multiple input capacitors can limit the input tracking inductance. Adding more input capacitors is available to restrict the ringing and to keep it below the device absolute maximum ratings.

Output Capacitor Selection (C_{OUT})

The output capacitor should be placed as close as possible to the OUT pin. 4.7μF or larger X7R or X5R ceramic capacitor is selected to get good dynamic performance. The minimum effective capacitance of C_{OUT} that makes SGM2232xQ remain stable is 2.2μF. For ceramic capacitor, temperature, DC bias and package size will change the effective capacitance, so enough margin of C_{OUT} must be considered in design. Additionally, C_{OUT} with larger capacitance and lower ESR will help increase the high frequency PSRR and improve the load transient response.

Under-Voltage Lockout (UVLO)

The UVLO circuit monitors the input voltage to prevent the device from turning on before V_{IN} rises above the V_{UVLO} threshold. The UVLO circuit responds quickly to

glitches on the IN pin and attempts to disable the output of the device if any of these rails collapses. The local input capacitance prevents severe brownouts in most applications.

Output Current Limit and Short-Circuit Protection

When overload events happen, the output current is internally limited. When the OUT pin is shorted to ground, the short-circuit protection will limit the output current.

Thermal Shutdown

When the die temperature exceeds the threshold value of thermal shutdown, the SGM2232xQ will be in shutdown state and it will remain in this state until the die temperature decreases to +150°C.

Power Dissipation (P_D)

Power dissipation (P_D) of the SGM2232xQ can be calculated by the equation $P_D = (V_{IN} - V_{OUT}) \times I_{OUT}$. The maximum allowable power dissipation (P_{D(MAX)}) of the SGM2232xQ is affected by many factors, including the difference between junction temperature and ambient temperature (T_{J(MAX)} - T_A), package thermal resistance from the junction to the ambient environment (θ_{JA}), the rate of ambient airflow and PCB layout. P_{D(MAX)} can be approximated by the following equation:

$$P_{D(MAX)} = (T_{J(MAX)} - T_A) / \theta_{JA} \quad (1)$$

Layout Guidelines

To get good PSRR, low output noise and high transient response performance, the input and output bypass capacitors must be placed as close as possible to the IN pin and OUT pin separately.

PACKAGE OUTLINE DIMENSIONS

SOT-223-3

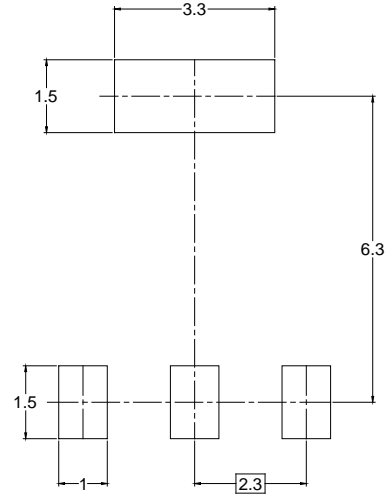
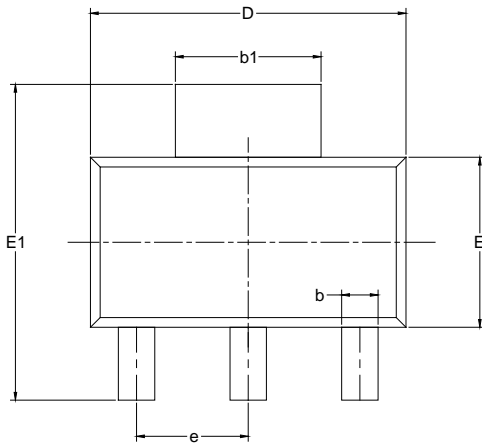

RECOMMENDED LAND PATTERN (Unit: mm)

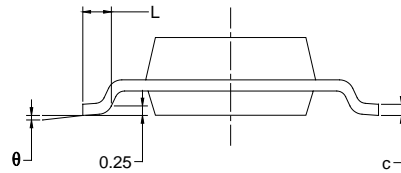
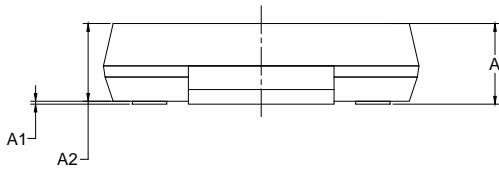

Symbol	Dimensions In Millimeters		Dimensions In Inches	
	MIN	MAX	MIN	MAX
A		1.800		0.071
A1	0.020	0.100	0.001	0.004
A2	1.500	1.700	0.059	0.067
b	0.660	0.840	0.026	0.033
b1	2.900	3.100	0.114	0.122
c	0.230	0.350	0.009	0.014
D	6.300	6.700	0.248	0.264
E	3.300	3.700	0.130	0.146
E1	6.700	7.300	0.264	0.287
e	2.300 BSC		0.091 BSC	
L	0.750		0.030	
θ	0°	10°	0°	10°

NOTES:

1. Body dimensions do not include mode flash or protrusion.
2. This drawing is subject to change without notice.

PACKAGE INFORMATION

PACKAGE OUTLINE DIMENSIONS

SOT-23-5

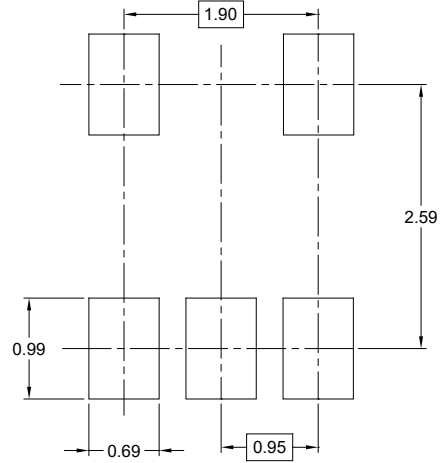
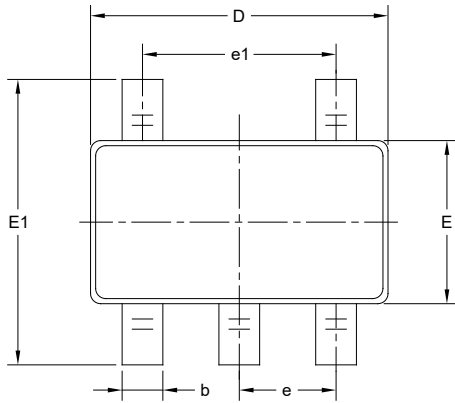

RECOMMENDED LAND PATTERN (Unit: mm)

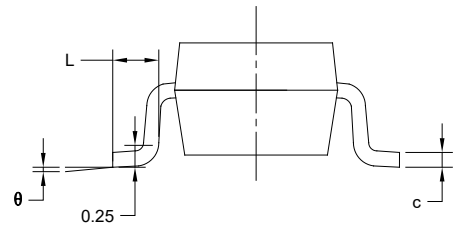
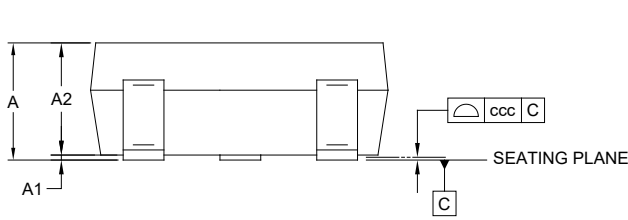

Symbol	Dimensions In Millimeters		
	MIN	MOD	MAX
A	-	-	1.450
A1	0.000	-	0.150
A2	0.900	-	1.300
b	0.300	-	0.500
c	0.080	-	0.220
D	2.750	-	3.050
E	1.450	-	1.750
E1	2.600	-	3.000
e	0.950 BSC		
e1	1.900 BSC		
L	0.300	-	0.600
θ	0°	-	8°
ccc	0.100		

NOTES:

1. This drawing is subject to change without notice.
2. The dimensions do not include mold flashes, protrusions or gate burrs.
3. Reference JEDEC MO-178.

PACKAGE INFORMATION

TAPE AND REEL INFORMATION

REEL DIMENSIONS



TAPE DIMENSIONS



NOTE: The picture is only for reference. Please make the object as the standard.

KEY PARAMETER LIST OF TAPE AND REEL

Package Type	Reel Diameter	Reel Width W1 (mm)	A0 (mm)	B0 (mm)	K0 (mm)	P0 (mm)	P1 (mm)	P2 (mm)	W (mm)	Pin1 Quadrant
SOT-223-3	13"	12.4	6.55	7.25	1.90	4.0	8.0	2.0	12.0	Q3
SOT-23-5	7"	9.5	3.20	3.20	1.40	4.0	4.0	2.0	8.0	Q3

DD0001

PACKAGE INFORMATION

CARTON BOX DIMENSIONS



NOTE: The picture is only for reference. Please make the object as the standard.

KEY PARAMETER LIST OF CARTON BOX

Reel Type	Length (mm)	Width (mm)	Height (mm)	Pizza/Carton
7" (Option)	368	227	224	8
7"	442	410	224	18
13"	386	280	370	5

DD0002