

### GENERAL DESCRIPTION

The SGM12CB1A5 is a low capacitance ESD protection device designed to protect circuits from electrostatic discharge.

### FEATURES

- **High ESD Withstand Voltage:**  
IEC 61000-4-2:  $\pm 30\text{kV}$  (Air)  
IEC 61000-4-2:  $\pm 30\text{kV}$  (Contact)
- **Rated Peak Pulse Current: 5A**
- **1.0pF (TYP) Channel Input Capacitance**
- **Low Profile Package: UTDFN-1 $\times$ 0.6-2L**
- **Working Voltage: 12V and Below**

### APPLICATIONS

Cellular Handsets & Accessories  
Computers and Peripherals  
Audio and Video Equipment  
SIM Card Protection  
Portable Electronics  
10/100Mbit/s Ethernet

### ABSOLUTE MAXIMUM RATINGS

PARAMETER	SYMBOL	VALUE	UNITS
Peak Pulse Current ( $t_p$ : 8/20 $\mu\text{s}$ )	$I_{PPM}$	5	A
ESD IEC 61000-4-2 (Air)	$V_{ESD}$	$\pm 30$	kV
ESD IEC 61000-4-2 (Contact)		$\pm 30$	
Operating Temperature Range	$T_{OP}$	-40 to +125	$^{\circ}\text{C}$
Storage Temperature Range	$T_{STG}$	-55 to +150	$^{\circ}\text{C}$
Lead Temperature (Soldering, 10s)		+260	$^{\circ}\text{C}$

Stresses beyond those listed in Absolute Maximum Ratings may cause permanent damage to the device. Exposure to absolute maximum rating conditions for extended periods may affect reliability.

### PRODUCT SUMMARY

$V_{RWM}$ (TYP)	$I_{PPM}$ (TYP)	$C_{IN}$ (TYP)
12V	5A	1.0pF

### PIN CONFIGURATION

(TOP VIEW)

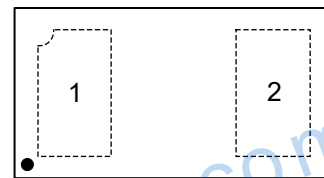

UTDFN-1 $\times$ 0.6-2L

### EQUIVALENT CIRCUIT



**PACKAGE/ORDERING INFORMATION**

MODEL	PACKAGE DESCRIPTION	SPECIFIED TEMPERATURE RANGE	ORDERING NUMBER	PACKAGE MARKING	PACKING OPTION
SGM12CB1A5	UTDFN-1x0.6-2L	-40°C to +125°C	SGM12CB1A5XUEG2G/TR	07X	Tape and Reel, 10000

**MARKING INFORMATION**

NOTE: X = Date Code.

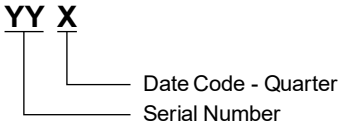

Green (RoHS & HSF): SG Micro Corp defines "Green" to mean Pb-Free (RoHS compatible) and free of halogen substances. If you have additional comments or questions, please contact your SGMICRO representative directly.

**DISCLAIMER**

SG Micro Corp reserves the right to make any change in circuit design, or specifications without prior notice.

**ELECTRICAL PARAMETERS**

SYMBOL	PARAMETER
$V_{RWM}$	Reverse Stand-Off Voltage
$V_{BR}$	Reverse Breakdown Voltage
$I_R$	Reverse Leakage Current
$I_R @ BR$	Reverse Leakage Current @ Breakdown
$V_C$	Clamping Voltage @ $I_{PP}$
$I_{PP}$	Peak Pulse Current
$R_{DYN}$	Dynamic Resistance

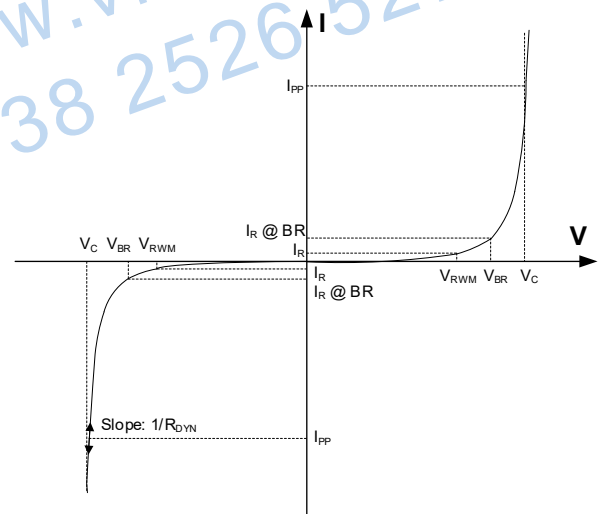

**ELECTRICAL CHARACTERISTICS**

(T<sub>A</sub> = +25°C, unless otherwise noted.)

PARAMETER	SYMBOL	CONDITIONS	MIN	TYP	MAX	UNITS
Reverse Stand-Off Voltage	V <sub>RWM</sub>				12	V
Reverse Breakdown Voltage	V <sub>BR</sub>	I <sub>R</sub> = 1mA	13.2	15	17.5	V
Reverse Leakage Current	I <sub>R</sub>	V <sub>R</sub> = 12V		10	100	nA
Channel Input Capacitance	C <sub>IN</sub>	V <sub>R</sub> = 0V, f = 1MHz, I/O to GND		1.0	1.5	pF
Surge Clamping Voltage <sup>(1)</sup>	V <sub>C-Surge</sub>	I <sub>PPM</sub> = 5A		18.6		V
ESD Clamping Voltage <sup>(2)</sup>	V <sub>C</sub>	I <sub>TLP</sub> = 8A (Equivalent IEC61000-4-2 Contact +4kV)		18.2		V
		I <sub>TLP</sub> = 16A (Equivalent IEC61000-4-2 Contact +8kV)		22.3		V
Dynamic Resistance <sup>(2)</sup>	R <sub>DYN</sub>	t <sub>p</sub> = 100ns		0.51		Ω

NOTES:

1. Non-repetitive current pulse 8/20μs exponential decay waveform according to IEC 61000-4-5, 2Ω source impedance.
2. Non-repetitive current pulse. Transmission line pulse (TLP) t<sub>p</sub> = 100ns, square pulse.

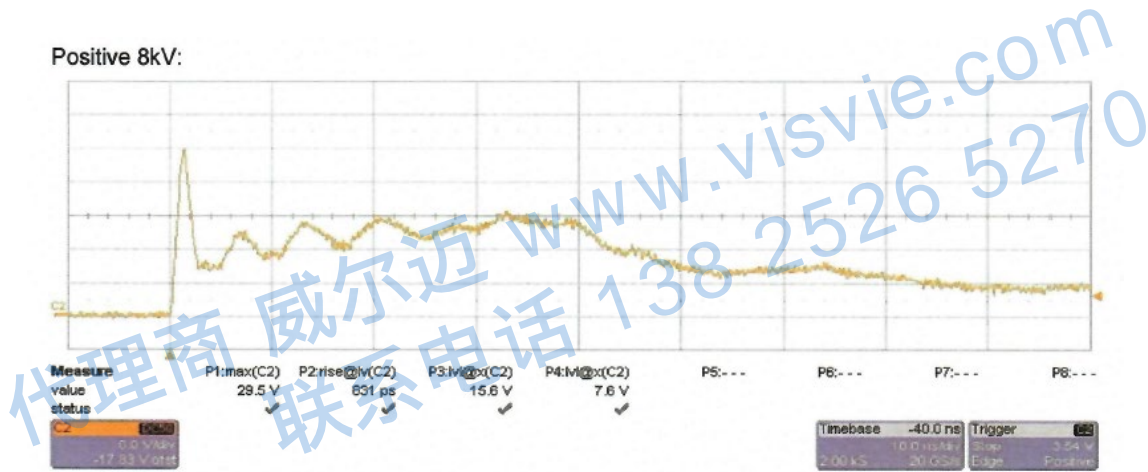

Figure 1. Typical Pulses ESD 8kV Contact per IEC 61000-4-2

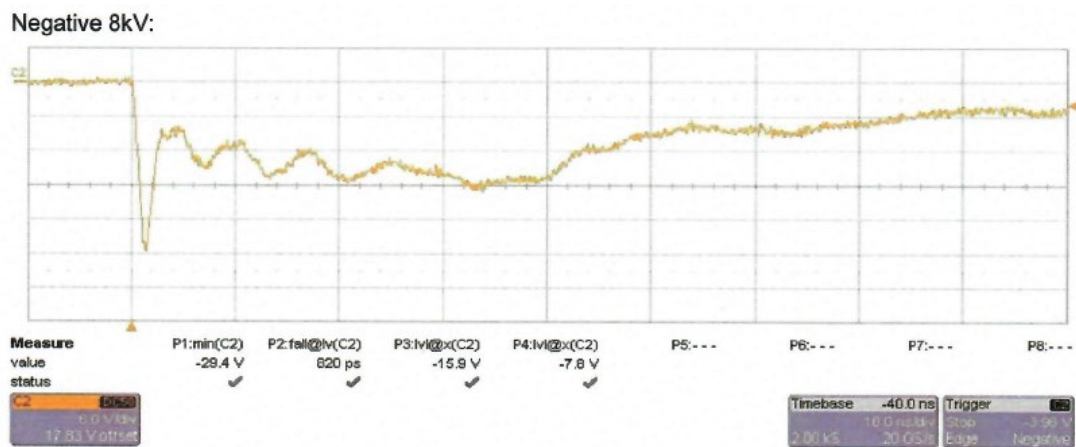
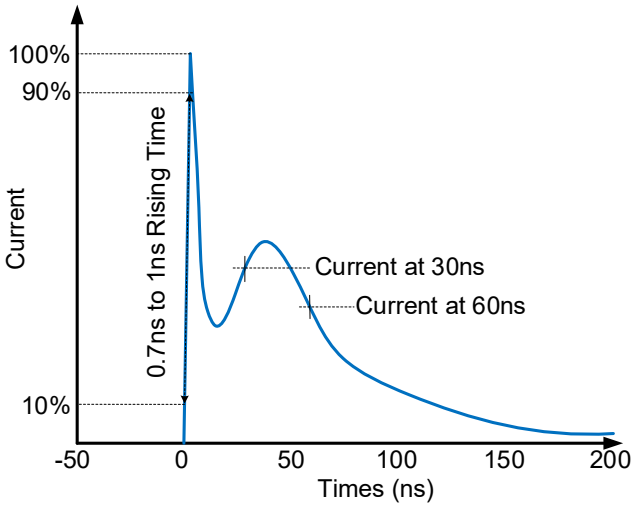

Figure 2. Typical Pulses ESD -8kV Contact per IEC 61000-4-2

TYPICAL PERFORMANCE CHARACTERISTICS

ESD Pulse Waveform per IEC 61000-4-2



8/20μs Waveform per IEC 61000-4-5

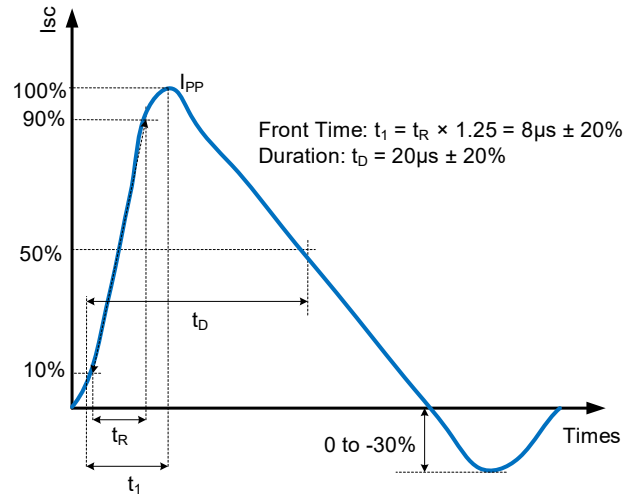

TLP\_Pin1(-) to Pin2(+)

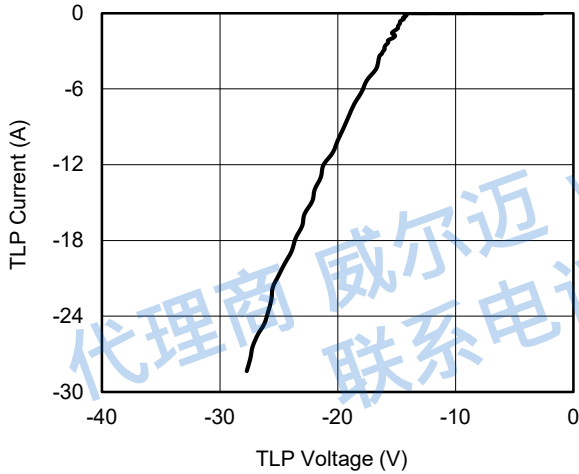

TLP\_Pin1(+) to Pin2(-)

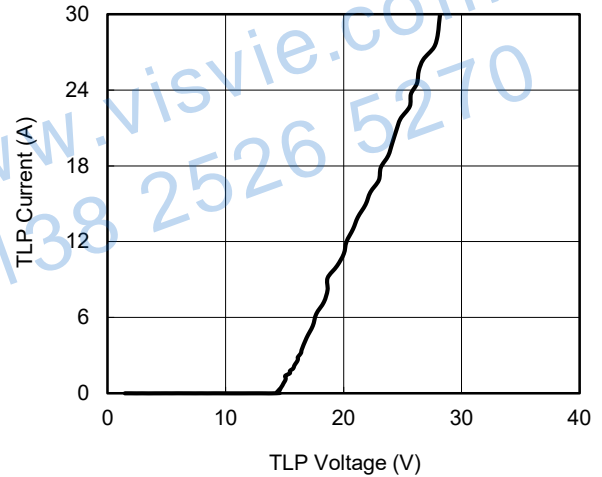

IV Curve

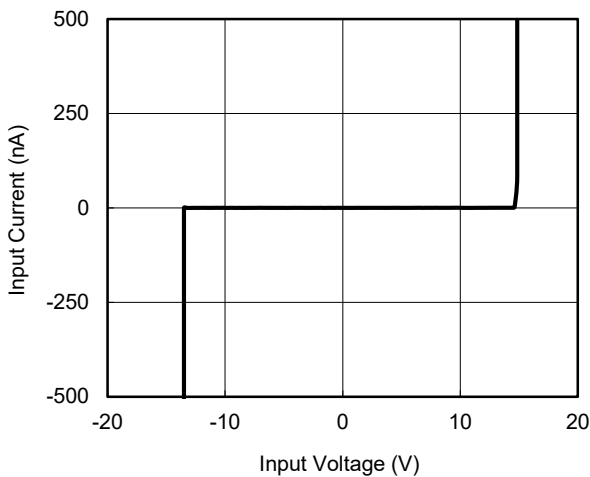

Capacitance vs. Reverse Voltage

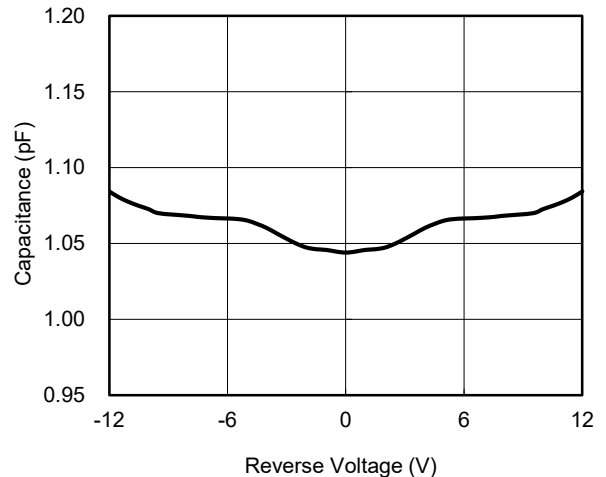

**APPLICATION INFORMATION**

The SGM12CB1A5 is designed to provide a bidirectional line for dissipating ESD events on high-speed signal. And it is suitable for lines with positive and negative signal polarity relative to the ground.

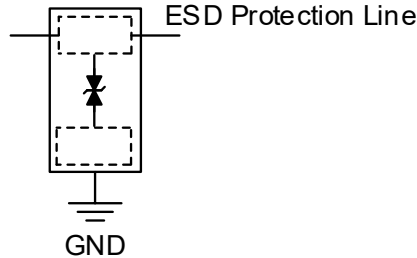

The following guidelines are recommended:

**1. TVS Placement**

Place the TVS as close to the input connector as possible.

**2. TVS's Trace Layout**

Avoid running protected traces in parallel with unprotected traces.  
 Minimize the path length between the TVS and the protected line.  
 Minimize parallel signal path length.  
 Route the protected traces as straight as possible.

**3. GND Layout**

Avoid using a common ground point shared with the TVS transient return path.  
 Minimize the length of the TVS transient return path to ground.  
 Use ground vias as close as possible to the TVS transient return to ground.

代理商 联系电话 2526 5270 www.visvie.com

**REVISION HISTORY**

NOTE: Page numbers for previous revisions may differ from page numbers in the current version.

Changes from Original (DECEMBER 2023) to REV.A	Page
Changed from Product Preview to Production Data .....	All

# PACKAGE INFORMATION

## PACKAGE OUTLINE DIMENSIONS

### UTDFN-1x0.6-2L

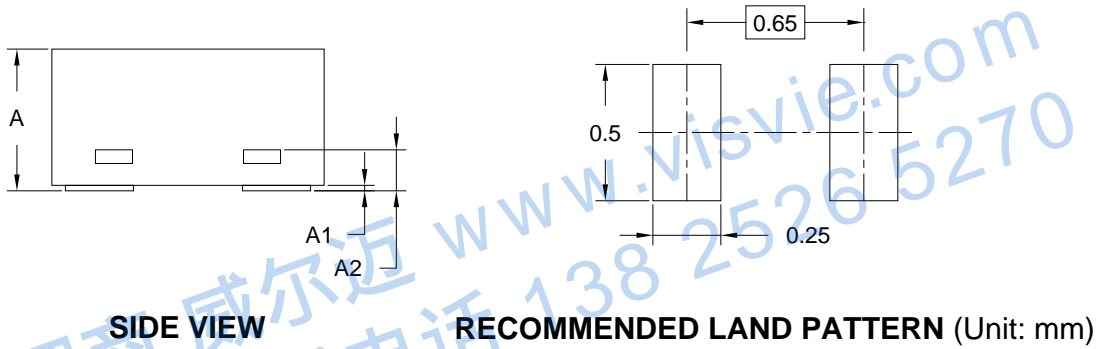
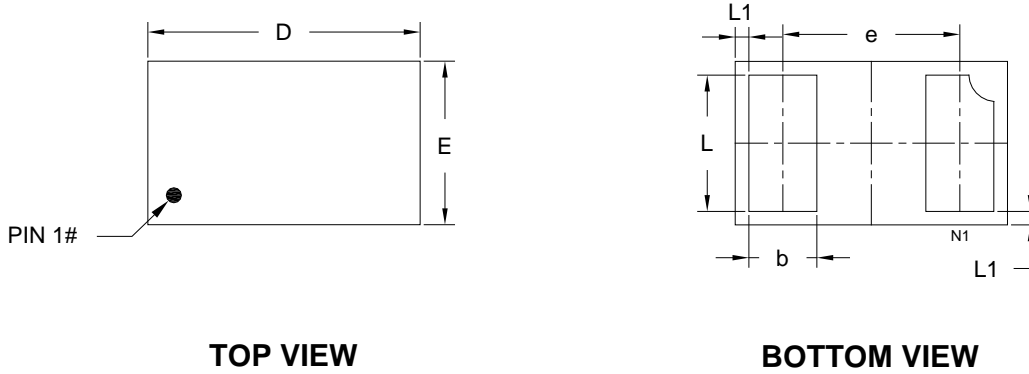

Symbol	Dimensions In Millimeters		
	MIN	MOD	MAX
A	0.450	0.500	0.550
A1	0.000	-	0.050
A2	0.120	0.150	0.180
b	0.200	0.250	0.300
D	0.950	1.000	1.050
E	0.550	0.600	0.650
e	0.650 BSC		
L	0.450	0.500	0.550
L1	0.050 REF		

NOTE: This drawing is subject to change without notice.

TAPE AND REEL INFORMATION

REEL DIMENSIONS

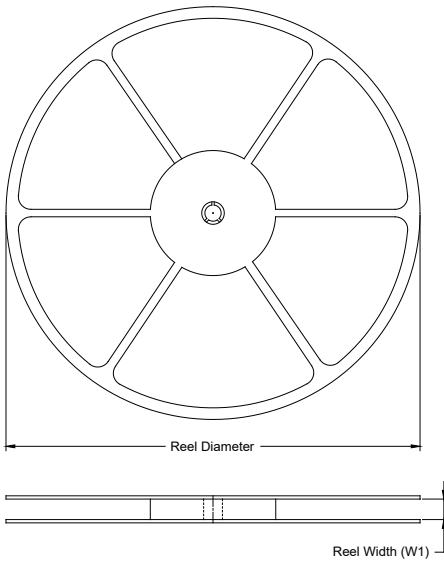

TAPE DIMENSIONS

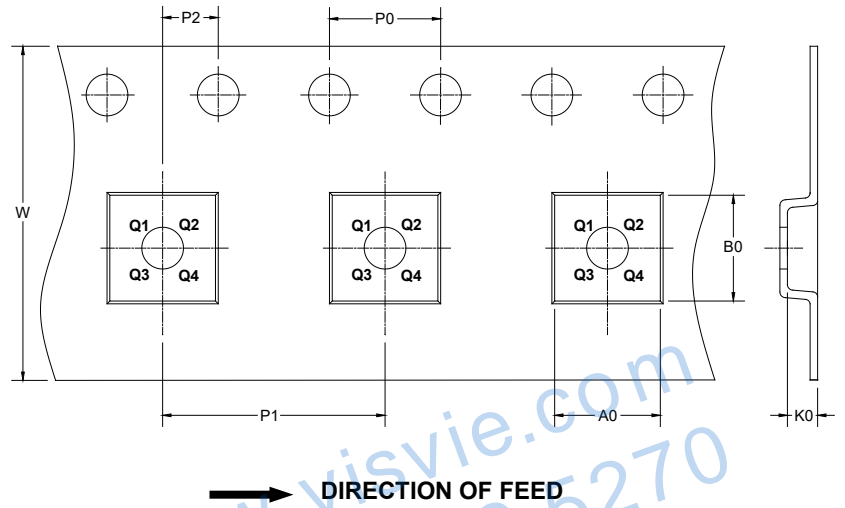

NOTE: The picture is only for reference. Please make the object as the standard.

KEY PARAMETER LIST OF TAPE AND REEL

Package Type	Reel Diameter	Reel Width W1 (mm)	A0 (mm)	B0 (mm)	K0 (mm)	P0 (mm)	P1 (mm)	P2 (mm)	W (mm)	Pin1 Quadrant
UTDFN-1×0.6-2L	7"	8.6	0.70	1.15	0.57	4.0	2.0	2.0	8.0	Q1

DD0001

## CARTON BOX DIMENSIONS

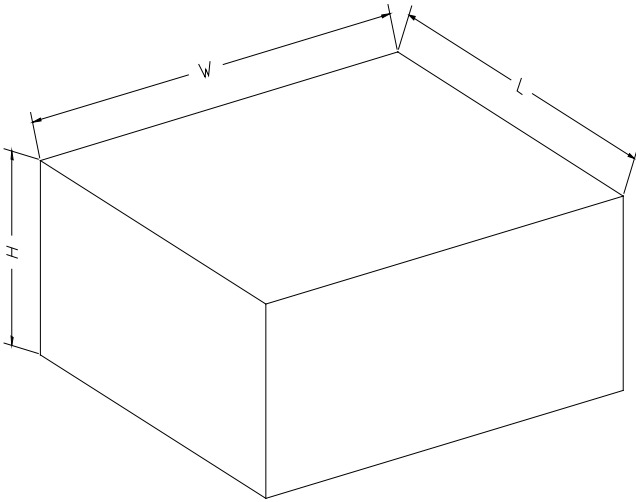

NOTE: The picture is only for reference. Please make the object as the standard.

## KEY PARAMETER LIST OF CARTON BOX

Reel Type	Length (mm)	Width (mm)	Height (mm)	Pizza/Carton
7" (Option)	368	227	224	8
7"	442	410	224	18

DD0002