



SGM2085xQ

Automotive, 300mA, Low Noise, High PSRR, Low I_Q and Low Dropout Regulator

GENERAL DESCRIPTION

The SGM2085xQ is an ultra-low noise, high PSRR and low dropout voltage linear regulator. It capable of supplying 300mA output current with typical dropout voltage of only 180mV. The operating input voltage range is from 1.6V to 5.5V and output voltage range is from 0.75V to 5.0V.

Other features include 1.2V logic-controlled shutdown mode, under-voltage lockout, short-circuit current limit and thermal shutdown protection. The SGM2085xQ has automatic discharge function to quickly discharge V_{OUT} in the disabled status.

This device is AEC-Q100 qualified (Automotive Electronics Council (AEC) standard Q100 Grade 1) and it is suitable for automotive applications.

The SGM2085xQ is available in a Green SOT-23-5 package. It operates over an operating temperature range of -40°C to +125°C.

APPLICATIONS

General Purpose Automotive & Industrial
Automotive Camera Modules
Automotive ADAS, Infotainment and Body

FEATURES

- **AEC-Q100 Qualified for Automotive Applications Device Temperature Grade 1**
T_A = -40°C to +125°C
- **Operating Input Voltage Rang: 1.6V to 5.5V**
- **Enable Pin Accept Voltages Higher than the Supply Voltage and up to 5.5V**
- **Fixed Output from 0.75V to 4.2V**
- **Adjustable Output from 0.8V to 5.0V**
- **Low Quiescent Current: 25μA (TYP)**
- **Low Dropout Voltage: 180mV (TYP) at 300mA**
- **Power Supply Rejection Ratio:**
 - ◆ **SGM2085-1.8Q:**
70dB (TYP) at 1kHz, 64dB (TYP) at 1MHz
 - ◆ **SGM2085-ADJQ:**
75dB (TYP) at 1kHz, 40dB (TYP) at 1MHz
- **Current Limiting and Thermal Protection**
- **Low Start-Up Current**
- **UVLO with Hysteresis**
- **Supports 1.2V Logic Enable Input for ON/OFF Control**
- **With Output Automatic Discharge**
- **Stable with Small Case Size Ceramic Capacitors**
- **-40°C to +125°C Operating Temperature Range**
- **Available in a Green SOT-23-5 Package**

TYPICAL APPLICATION

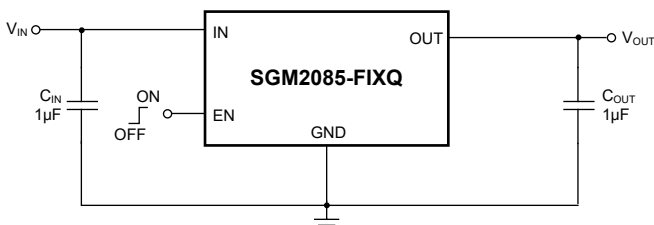

Fixed Voltage Typical Application Circuit

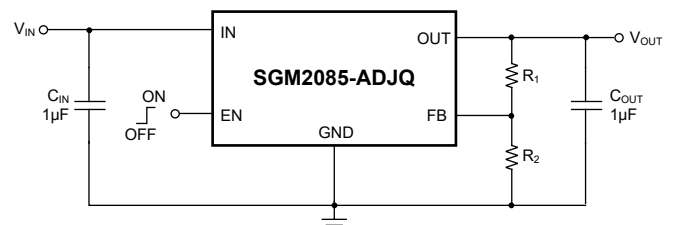

Adjustable Voltage Typical Application Circuit

Figure 1. Typical Application Circuits

Automotive, 300mA, Low Noise, High PSRR, SGM2085xQ Low I_Q and Low Dropout Regulator

PACKAGE/ORDERING INFORMATION

MODEL	PACKAGE DESCRIPTION	SPECIFIED TEMPERATURE RANGE	ORDERING NUMBER	PACKAGE MARKING	PACKING OPTION
SGM2085-0.75Q	SOT-23-5	-40°C to +125°C (T _A)	SGM2085-0.75QN5G/TR	10O XXXXX	Tape and Reel, 3000
SGM2085-1.2Q	SOT-23-5	-40°C to +125°C (T _A)	SGM2085-1.2QN5G/TR	0Y8 XXXXX	Tape and Reel, 3000
SGM2085-1.5Q	SOT-23-5	-40°C to +125°C (T _A)	SGM2085-1.5QN5G/TR	10P XXXXX	Tape and Reel, 3000
SGM2085-1.8Q	SOT-23-5	-40°C to +125°C (T _A)	SGM2085-1.8QN5G/TR	0Y9 XXXXX	Tape and Reel, 3000
SGM2085-2.5Q	SOT-23-5	-40°C to +125°C (T _A)	SGM2085-2.5QN5G/TR	10Q XXXXX	Tape and Reel, 3000
SGM2085-2.8Q	SOT-23-5	-40°C to +125°C (T _A)	SGM2085-2.8QN5G/TR	10R XXXXX	Tape and Reel, 3000
SGM2085-2.9Q	SOT-23-5	-40°C to +125°C (T _A)	SGM2085-2.9QN5G/TR	10S XXXXX	Tape and Reel, 3000
SGM2085-3.0Q	SOT-23-5	-40°C to +125°C (T _A)	SGM2085-3.0QN5G/TR	10T XXXXX	Tape and Reel, 3000
SGM2085-3.3Q	SOT-23-5	-40°C to +125°C (T _A)	SGM2085-3.3QN5G/TR	0YA XXXXX	Tape and Reel, 3000
SGM2085-4.2Q	SOT-23-5	-40°C to +125°C (T _A)	SGM2085-4.2QN5G/TR	0YB XXXXX	Tape and Reel, 3000
SGM2085-ADJQ	SOT-23-5	-40°C to +125°C (T _A)	SGM2085-ADJQN5G/TR	0YC XXXXX	Tape and Reel, 3000

MARKING INFORMATION

NOTE: XXXXX = Date Code, Trace Code and Vendor Code.

XXXXX



Green (RoHS & HSF): SG Micro Corp defines "Green" to mean Pb-Free (RoHS compatible) and free of halogen substances. If you have additional comments or questions, please contact your SGMICRO representative directly.

ABSOLUTE MAXIMUM RATINGS

IN to GND	-0.3V to 6V
OUT to GND	-0.3V to 6V
EN to GND	-0.3V to 6V
Package Thermal Resistance	
SOT-23-5, θ_{JA}	179.7°C/W
SOT-23-5, θ_{JB}	45.6°C/W
SOT-23-5, θ_{JC}	66.5°C/W
Junction Temperature	+150°C
Storage Temperature Range	-65°C to +150°C
Lead Temperature (Soldering, 10s)	+260°C

RECOMMENDED OPERATING CONDITIONS

Operating Input Voltage Range, V_{IN}	1.6V to 5.5V
Adjustable Output Voltage Range	0.8V to 5.0V
Enable Voltage Range	0V to 5.5V
Input Effective Capacitance, C_{IN}	0.5 μ F (MIN)
Output Effective Capacitance, C_{OUT}	0.5 μ F to 100 μ F
Operating Ambient Temperature Range	-40°C to +125°C
Operating Junction Temperature Range	-40°C to +150°C

OVERSTRESS CAUTION

Stresses beyond those listed in Absolute Maximum Ratings may cause permanent damage to the device. Exposure to absolute maximum rating conditions for extended periods may affect reliability. Functional operation of the device at any conditions beyond those indicated in the Recommended Operating Conditions section is not implied.

ESD SENSITIVITY CAUTION

This integrated circuit can be damaged if ESD protections are not considered carefully. SGMICRO recommends that all integrated circuits be handled with appropriate precautions. Failure to observe proper handling and installation procedures can cause damage. ESD damage can range from subtle performance degradation to complete device failure. Precision integrated circuits may be more susceptible to damage because even small parametric changes could cause the device not to meet the published specifications.

DISCLAIMER

SG Micro Corp reserves the right to make any change in circuit design, or specifications without prior notice.

代理商 威尔迈 www.vicjo.com
联系电话 138 2526 5279

PIN CONFIGURATIONS

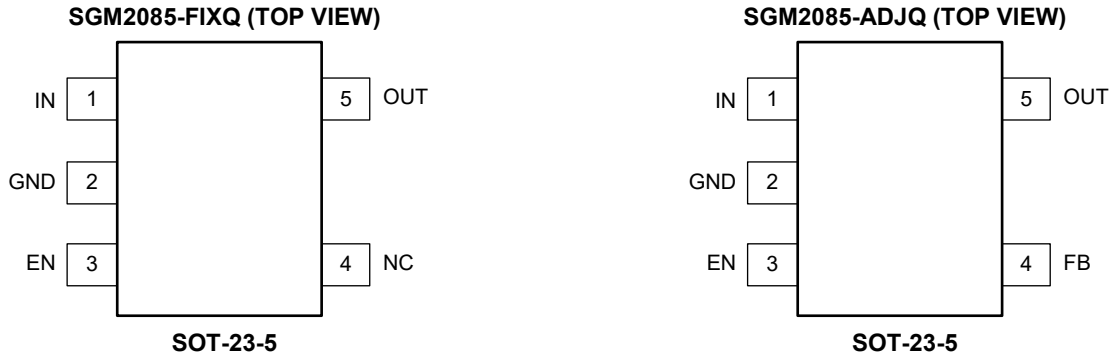

PIN DESCRIPTION

PIN	NAME	FUNCTION
1	IN	Input Supply Voltage Pin. It is recommended to use a 1μF or larger ceramic capacitor from IN pin to ground to get good power supply decoupling. This ceramic capacitor should be placed as close as possible to IN pin.
2	GND	Ground Pin.
3	EN	Enable Pin. Drive EN high to turn on the regulator. Drive EN low to turn off the regulator.
4	FB	Feedback Voltage Input Pin (adjustable voltage version only). Connect this pin to the midpoint of an external resistor divider to adjust the output voltage. Place the resistors as close as possible to this pin.
	NC	No Connection (fixed voltage version).
5	OUT	Regulator Output Pin. It is recommended to use a 1μF ceramic capacitor to ensure stability. This ceramic capacitor should be placed as close as possible to OUT pin.

SGM2085xQ Automotive, 300mA, Low Noise, High PSRR, Low I_Q and Low Dropout Regulator

FUNCTIONAL BLOCK DIAGRAMS

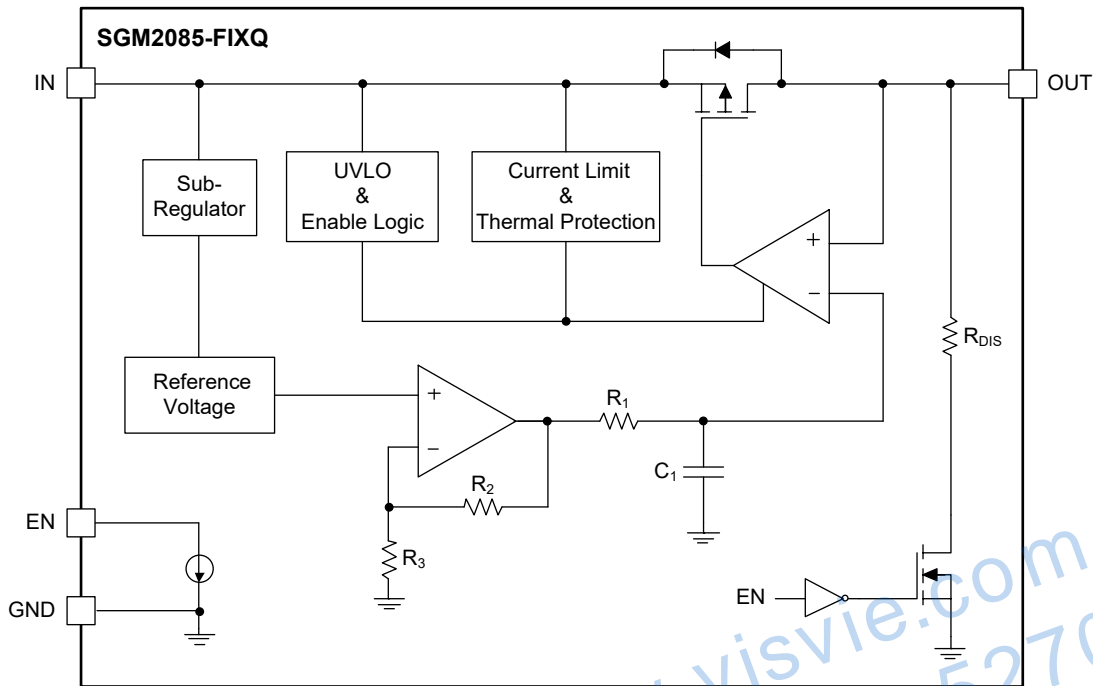

Figure 2. Fixed Output Regulator Block Diagram

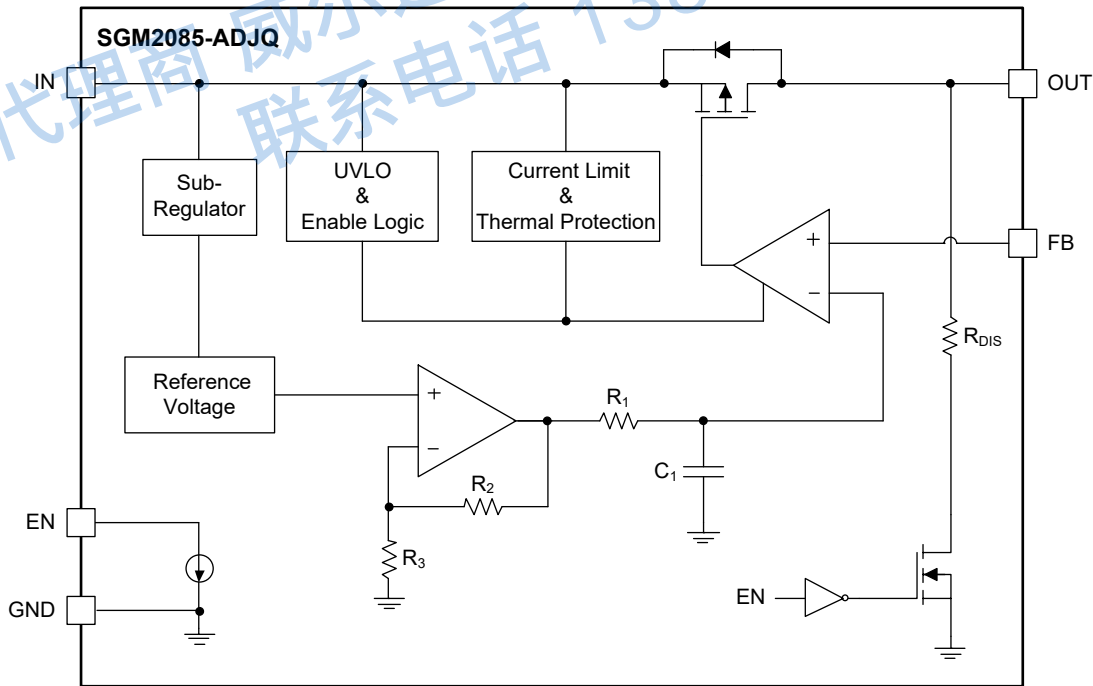

Figure 3. Adjustable Output Regulator Block Diagram

Automotive, 300mA, Low Noise, High PSRR, SGM2085xQ Low I_Q and Low Dropout Regulator

ELECTRICAL CHARACTERISTICS

(V_{IN} = (V_{OUT(NOM)} + 0.5V) or 1.6V (whichever is greater), V_{EN} = V_{IN}, I_{OUT} = 0.1mA, C_{OUT} = 1μF, T_J = -40°C to +125°C ⁽¹⁾, typical values are at T_J = +25°C, unless otherwise noted.)

PARAMETER	SYMBOL	CONDITIONS	MIN	TYP	MAX	UNITS
Input Voltage Range	V _{IN}	T _J = +25°C	1.6		5.5	V
Output Voltage Accuracy	V _{OUT}		TBD		TBD	%
Feedback Voltage	V _{ADJ}			0.8		V
Under-Voltage Lockout	V _{UVLO}	V _{IN} rising		1.37		V
		V _{IN} falling		1.18		
Line Regulation	ΔV _{OUT(ΔVIN)}	V _{IN} = (V _{OUT(NOM)} + 0.5V) or 1.6V (whichever is greater) to 5.5V		0.1		mV
Load Regulation	ΔV _{OUT(ΔIOUT)}	V _{IN} = (V _{OUT(NOM)} + 0.5V) or 1.8V (whichever is greater), I _{OUT} = 0.1mA to 300mA		1.3		mV
Dropout Voltage	V _{DROP}	V _{OUT} = V _{OUT(NOM)} - 50mV, I _{OUT} = 300mA	V _{OUT(NOM)} = 0.8V	850		mV
			V _{OUT(NOM)} = 1.8V	290		
			V _{OUT(NOM)} = 5.0V	180		
Output Current Limit	I _{LIMIT}	V _{IN} = V _{OUT(NOM)} + 1V, V _{OUT} = 90% × V _{OUT(NOM)}		550		mA
Short-Circuit Current	I _{SHORT}	V _{IN} = V _{OUT(NOM)} + 1V, V _{OUT} = 0V		270		mA
Ground Pin Current	I _{GND}	I _{OUT} = 0mA		25		μA
		I _{OUT} = 300mA		2.3		mA
Shutdown Current	I _{SHDN}	V _{EN} = 0V, V _{IN} = 1.6V to 5.5V		20		nA
EN Pin High-Level Input Voltage	V _{IH}	T _J = +25°C	0.8			V
EN Pin Low-Level Input Voltage	V _{IL}	T _J = +25°C			0.4	V
Enable Pin Current	I _{EN}	V _{IN} = V _{EN} = 5.5V		0.07		μA
Turn-On Time	t _{ON}	V _{IN} = 5.5V, from assertion of V _{EN} to V _{OUT} = 90% × V _{OUT(NOM)}		210		μs
Power Supply Rejection Ratio	PSRR	SGM2085-ADJQ, V _{IN} = 1.8V, V _{OUT} = 0.8V, I _{OUT} = 10mA	f = 1kHz	75		dB
			f = 1MHz	40		
		SGM2085-FIXQ, V _{IN} = 2.8V, V _{OUT} = 1.8V, I _{OUT} = 10mA	f = 1kHz	70		
			f = 1MHz	64		
Output Voltage Noise	e _n	f = 10Hz to 100kHz, V _{OUT} = 1.8V, I _{OUT} = 10mA		30		μV _{RMS}
Output Discharge Resistance	R _{DIS}	V _{EN} = 0V, V _{IN} = 1.6V		128		Ω
Thermal Shutdown Temperature	T _{SHDN}			175		°C
Thermal Shutdown Hysteresis	ΔT _{SHDN}			25		°C

NOTE:

1. Tested under pulse load conditions, so T_J ≈ T_A.

TYPICAL PERFORMANCE CHARACTERISTICS

T_J = -40°C to +125°C, V_{IN} = (V_{OUT(NOM)} + 0.5V) or 1.6V (whichever is greater), V_{EN} = V_{IN}, I_{OUT} = 10mA, C_{OUT} = 1μF, typical values are at T_J = +25°C, unless otherwise noted.

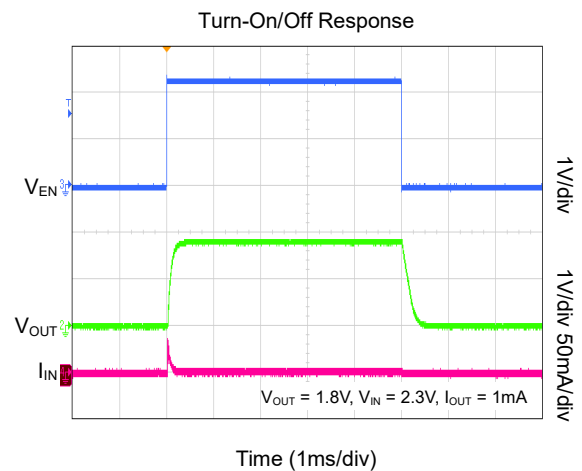
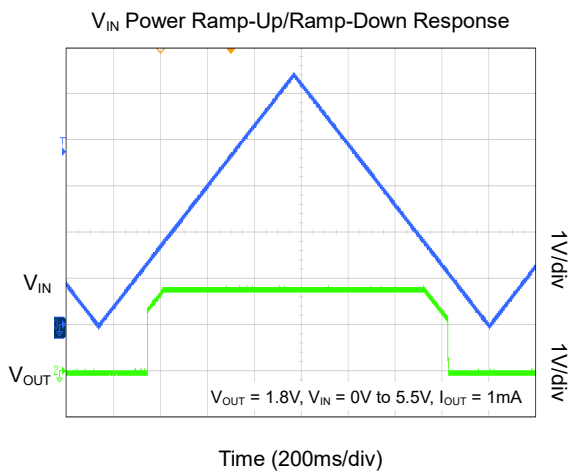
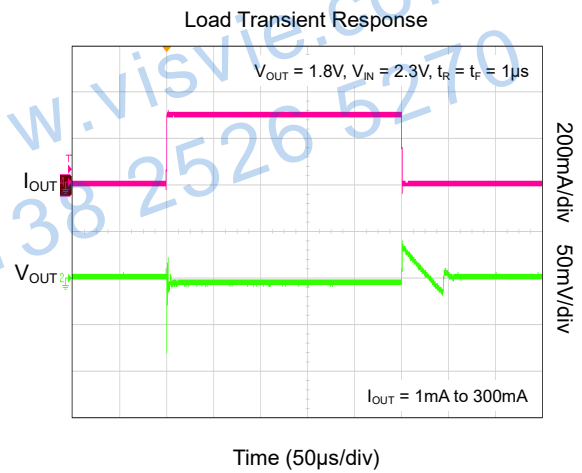
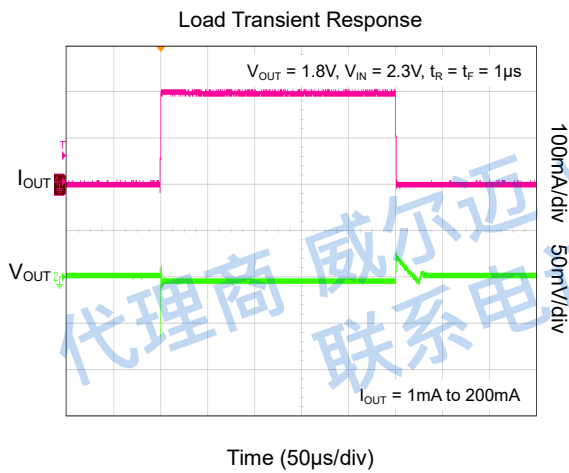
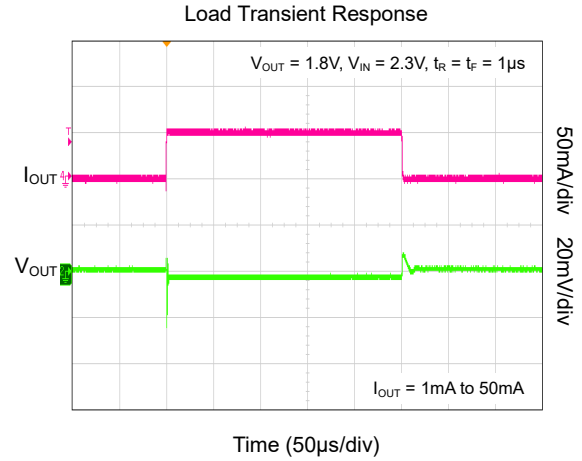
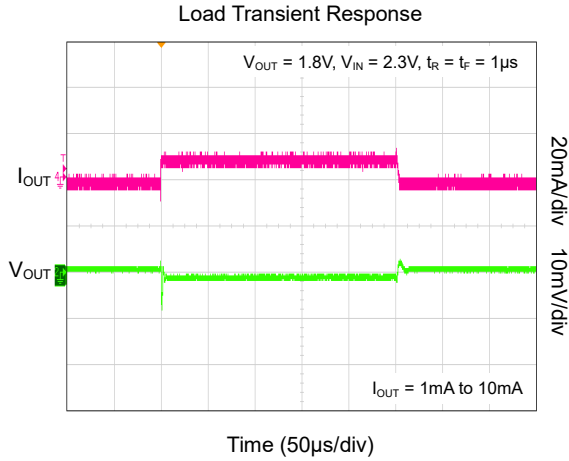

TYPICAL PERFORMANCE CHARACTERISTICS (continued)

T_J = -40°C to +125°C, V_{IN} = (V_{OUT(NOM)} + 0.5V) or 1.6V (whichever is greater), V_{EN} = V_{IN}, I_{OUT} = 10mA, C_{OUT} = 1μF, typical values are at T_J = +25°C, unless otherwise noted.

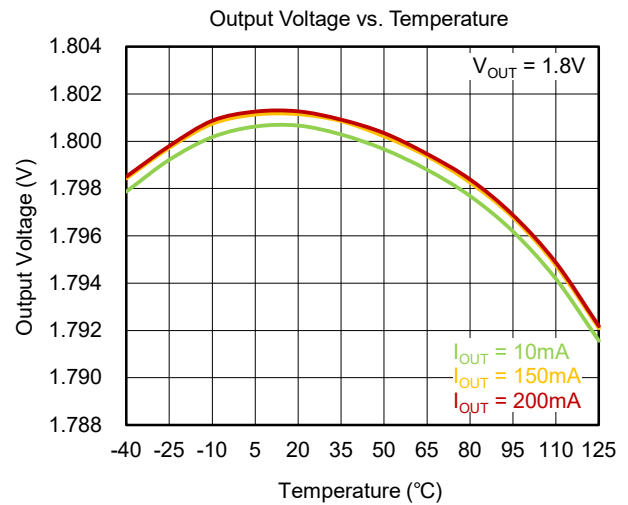
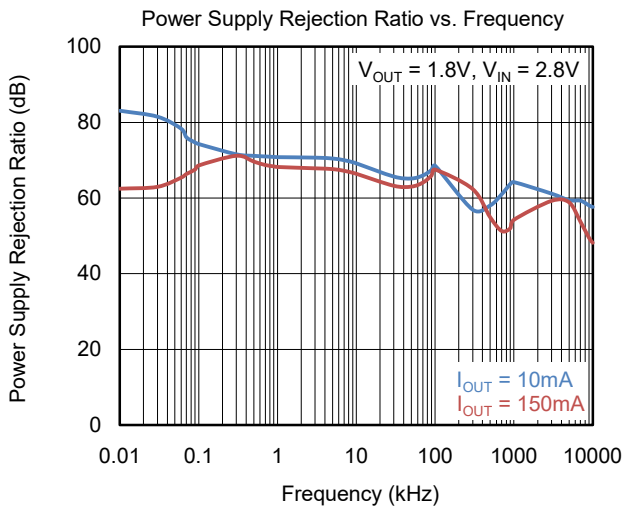
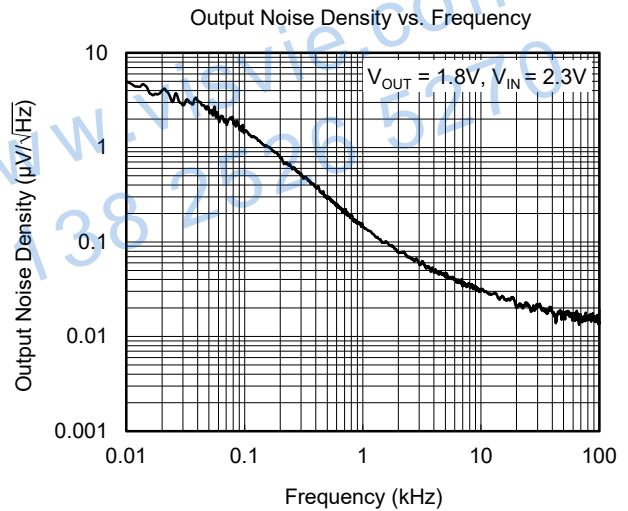
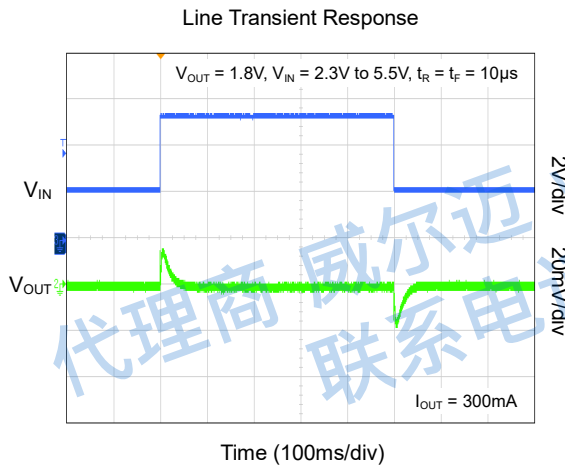
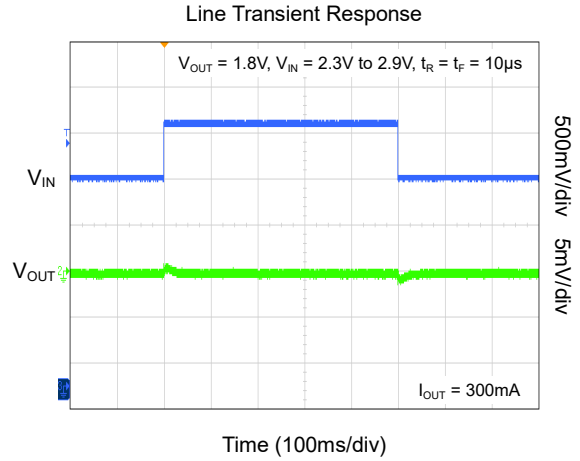
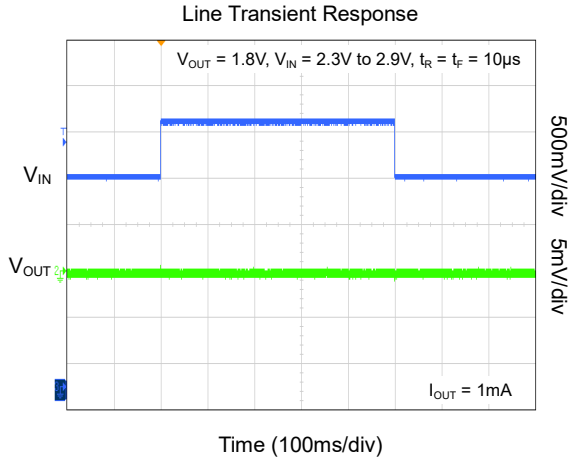

TYPICAL PERFORMANCE CHARACTERISTICS (continued)

T_J = -40°C to +125°C, V_{IN} = (V_{OUT(NOM)} + 0.5V) or 1.6V (whichever is greater), V_{EN} = V_{IN}, I_{OUT} = 10mA, C_{OUT} = 1μF, typical values are at T_J = +25°C, unless otherwise noted.

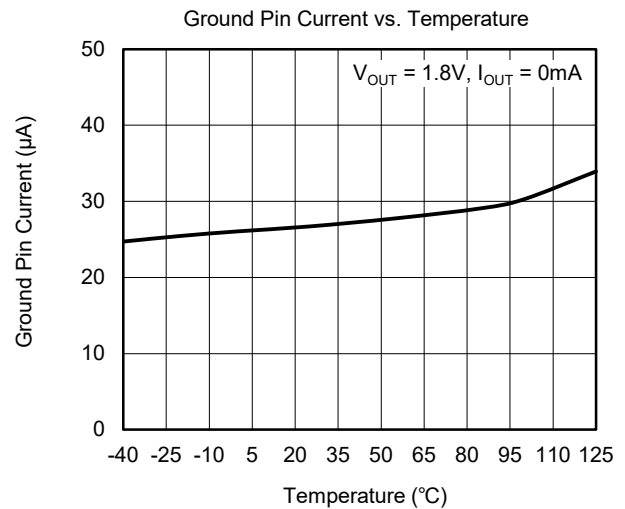
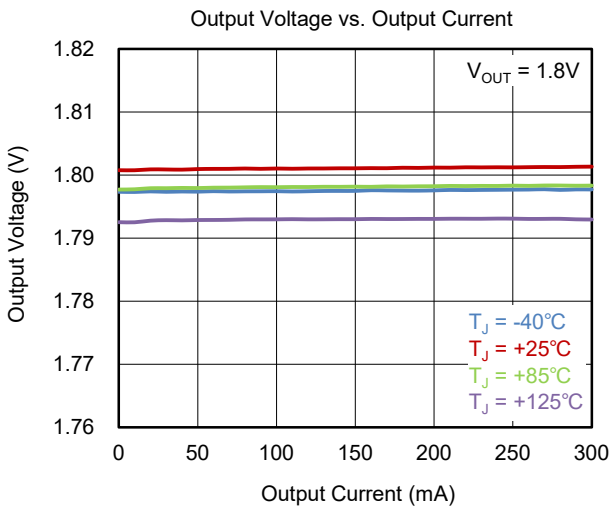
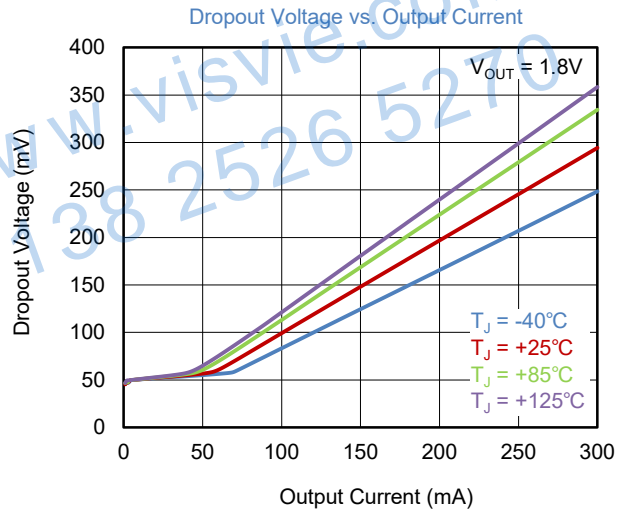
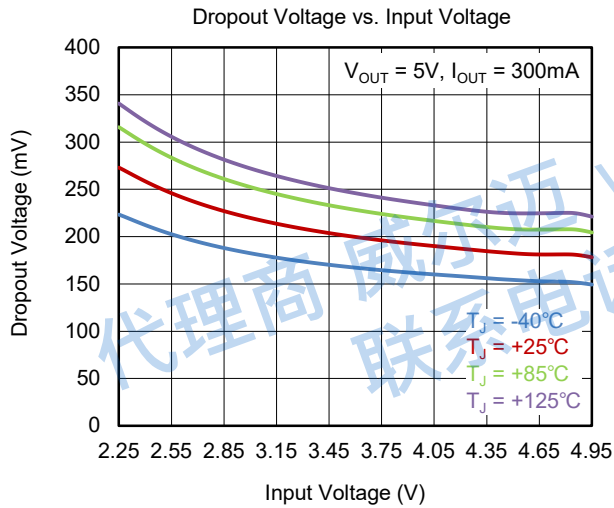
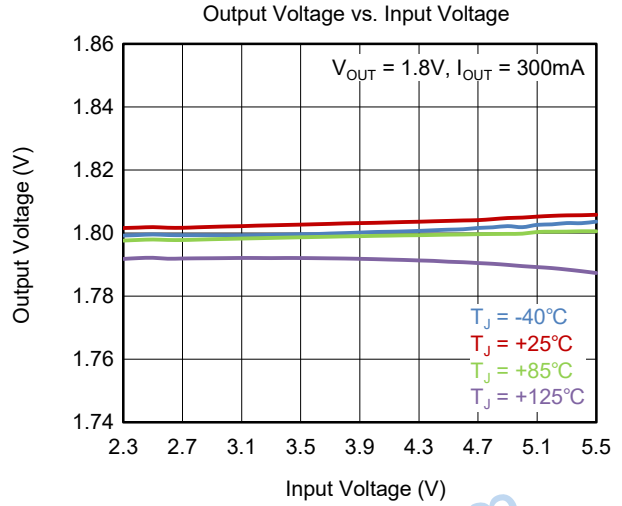
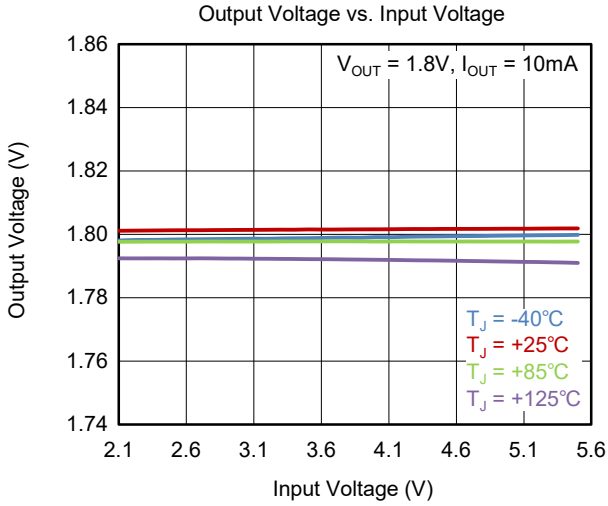

SGM2085xQ Automotive, 300mA, Low Noise, High PSRR, Low I_Q and Low Dropout Regulator

TYPICAL PERFORMANCE CHARACTERISTICS (continued)

T_J = -40°C to +125°C, V_{IN} = (V_{OUT(NOM)} + 0.5V) or 1.6V (whichever is greater), V_{EN} = V_{IN}, I_{OUT} = 10mA, C_{OUT} = 1μF, typical values are at T_J = +25°C, unless otherwise noted.

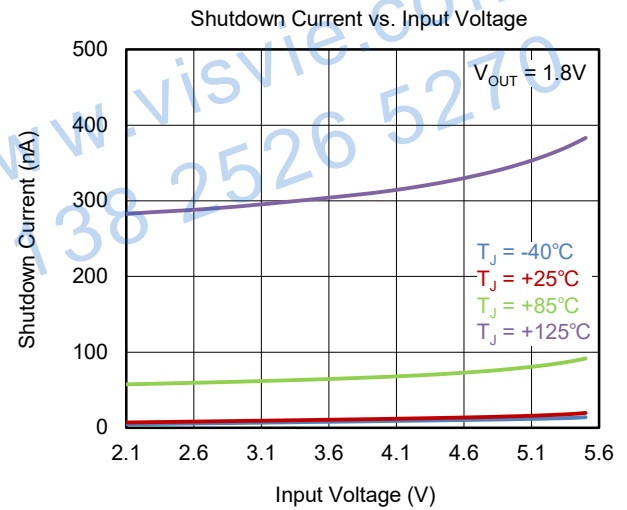
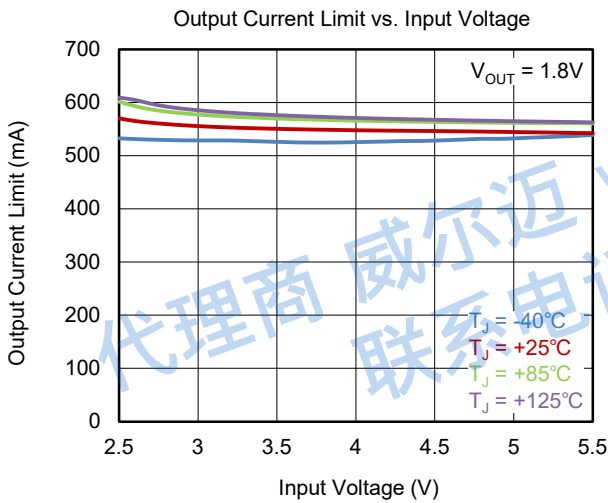
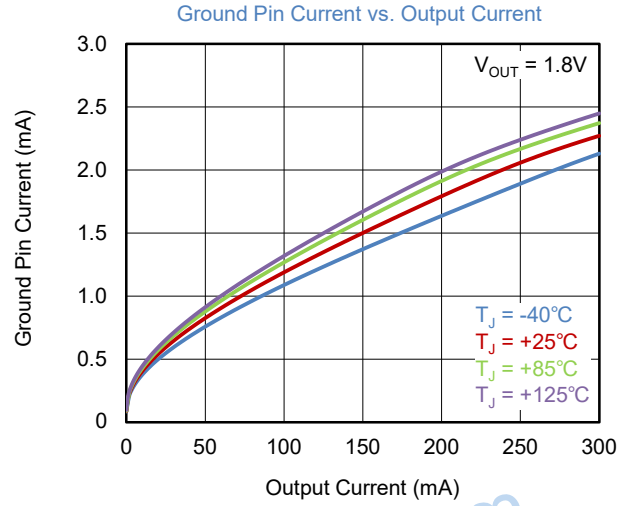
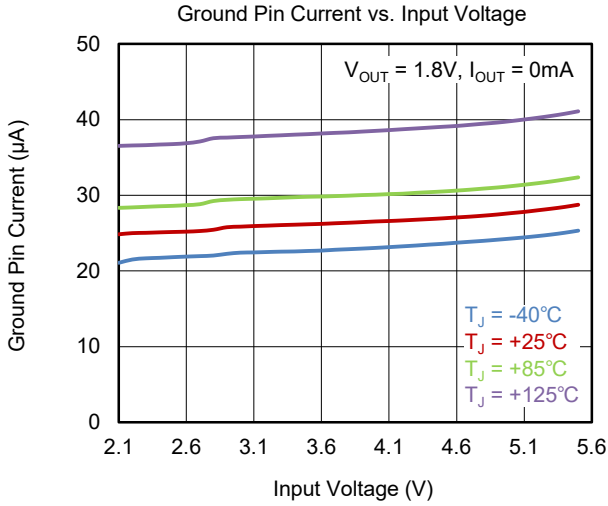

APPLICATION INFORMATION

The SGM2085xQ is a low noise, high PSRR, low I_Q and low dropout voltage linear regulator and provides 300mA output current. These features make the device a reliable solution to solve many challenging problems in the generation of clean and accurate power supply. The high performance also makes the SGM2085xQ useful in a variety of applications. The SGM2085xQ provides protection functions for output overload, output short-circuit condition and overheating.

The SGM2085xQ provides an EN pin as an external chip enable control to enable/disable the device. When the regulator is in shutdown state, the shutdown current consumes as low as 20nA (TYP).

Input Capacitor Selection (C_{IN})

The input decoupling should be placed as close as possible to the IN pin for ensuring the device stability. 1μF or larger X7R or X5R ceramic capacitor is selected to get good dynamic performance.

When V_{IN} is required to provide large current instantaneously, a large effective input capacitor is required. Multiple input capacitors can limit the input tracking inductance. Adding more input capacitors is available to restrict the ringing and to keep it below the device absolute maximum ratings. For C_{OUT} with larger capacitance, it is recommended to choose the larger capacitance C_{IN}.

Output Capacitor Selection (C_{OUT})

The output capacitor should be placed as close as possible to the OUT pin. 1μF or larger X7R or X5R ceramic capacitor is selected to get good dynamic performance. The minimum effective capacitance of C_{OUT} that SGM2085xQ can remain stable is 0.5μF. For ceramic capacitor, temperature, DC bias and package size will change the effective capacitance, so enough margin of C_{OUT} must be considered in design. Additionally, C_{OUT} with larger capacitance and lower ESR will help increase the high frequency PSRR and improve the load transient response.

Dropout Voltage and V_{IN}

The SGM2085xQ features low dropout voltage due to low R_{DS(ON)} PMOSFET power transistor. For Linear regulator, when (V_{IN} - V_{OUT}) < dropout voltage (V_{DROP}), the PMOSFET power transistor will be turned on like a switch and the parameter of linear regulator, such as

PSRR, load and input transient responses, will be degraded so much. To get good performance in application, the V_{IN} must be larger than (V_{OUT} + V_{DROP}).

Adjustable Regulator

The output voltage of the SGM2085-ADJQ can be adjusted from 0.8V to 5.0V. The FB pin will be connected to two external resistors as shown in Figure 4. The output voltage is determined by the following equation:

$$V_{OUT} = V_{ADJ} \times \left(1 + \frac{R_1}{R_2}\right) \quad (1)$$

where:

V_{OUT} is output voltage and V_{ADJ} is the internal voltage reference, V_{ADJ} = 0.8V.

One parallel capacitor (C_{FF}) with R₁ can be used to improve the feedback loop stability and PSRR, increase the transient response and reduce the output noise. R₁ and R₂ can be calculated for any output voltage range using equation 1. Choose R₂ = 20kΩ to maintain a 40μA minimum load.

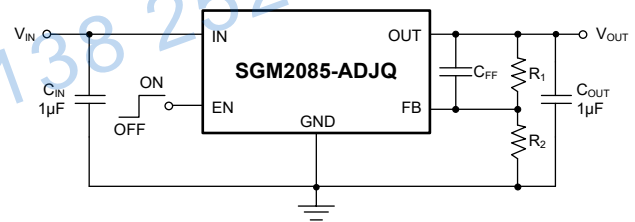

Figure 4. Adjustable Output Voltage Application

Enable Operation

The EN pin of the SGM2085xQ is used to enable/disable the device and to deactivate/activate the output automatic discharge function.

When the EN pin voltage is lower than 0.4V, the device is in shutdown state. There is no current flowing from IN to OUT pins. In this state, the automatic discharge transistor is active to discharge the output voltage through a 128Ω (TYP) resistor.

When the EN pin voltage is higher than 0.8V, the device is in active state. The output voltage is regulated to the expected value and the automatic discharge transistor is turned off.

APPLICATION INFORMATION (continued)**Under-Voltage Lockout (UVLO)**

To protect the device from malfunctioning when the input voltage is insufficient, under-voltage lockout (UVLO) protection is included. The device will not operate until the input voltage exceeds UVLO rising threshold, and will lockout if the input voltage falls below the UVLO falling threshold. The local input capacitance prevents severe brownouts in most applications.

Output Current Limit and Short-Circuit Protection

When overload events happen, the output current is internally limited to 550mA (TYP). When the OUT pin is shorted to ground, the short-circuit protection will limit the output current to 270mA (TYP).

Thermal Shutdown

When the die temperature exceeds the threshold value of thermal shutdown, the SGM2085xQ will be in

shutdown state and it will remain in this state until the die temperature decreases to +150°C.

Power Dissipation (P_D)

Power dissipation (P_D) of the SGM2085xQ can be calculated by the equation $P_D = (V_{IN} - V_{OUT}) \times I_{OUT}$. The maximum allowable power dissipation (P_{D(MAX)}) of the SGM2085xQ is affected by many factors, including the difference between junction temperature and ambient temperature (T_{J(MAX)} - T_A), package thermal resistance from the junction to the ambient environment (θ_{JA}), the rate of ambient airflow and PCB layout. P_{D(MAX)} can be approximated by the following equation:

$$P_{D(MAX)} = (T_{J(MAX)} - T_A) / \theta_{JA} \quad (2)$$

Layout Guidelines

To get good PSRR, low output noise and high transient response performance, the input and output bypass capacitors must be placed as close as possible to the IN pin and OUT pin separately.

代理商 威尔迈 www.vicor.com
联系电话 138 2526 5270

PACKAGE OUTLINE DIMENSIONS

SOT-23-5

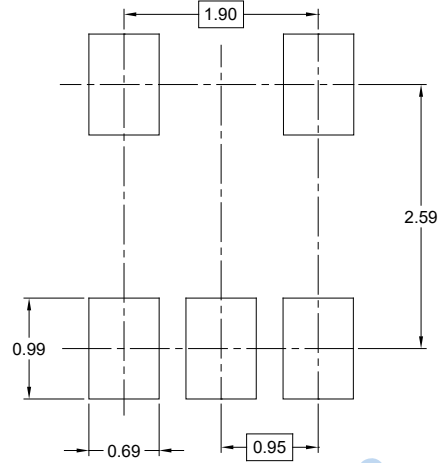
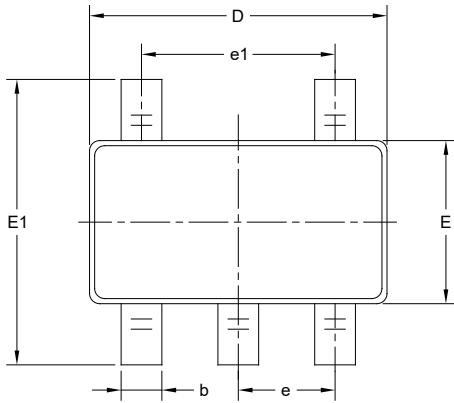

RECOMMENDED LAND PATTERN (Unit: mm)

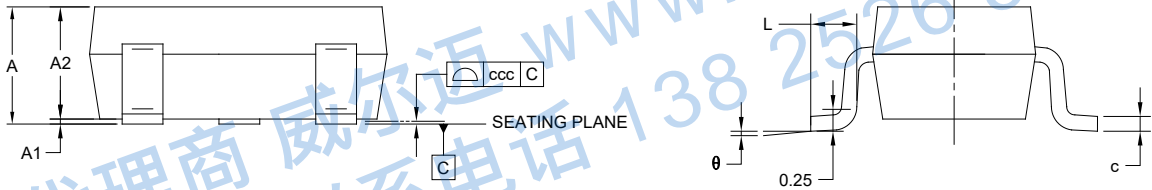

Symbol	Dimensions In Millimeters		
	MIN	MOD	MAX
A	-	-	1.450
A1	0.000	-	0.150
A2	0.900	-	1.300
b	0.300	-	0.500
c	0.080	-	0.220
D	2.750	-	3.050
E	1.450	-	1.750
E1	2.600	-	3.000
e	0.950 BSC		
e1	1.900 BSC		
L	0.300	-	0.600
θ	0°	-	8°
ccc	0.100		

NOTES:

1. This drawing is subject to change without notice.
2. The dimensions do not include mold flashes, protrusions or gate burrs.
3. Reference JEDEC MO-178.

TAPE AND REEL INFORMATION

REEL DIMENSIONS

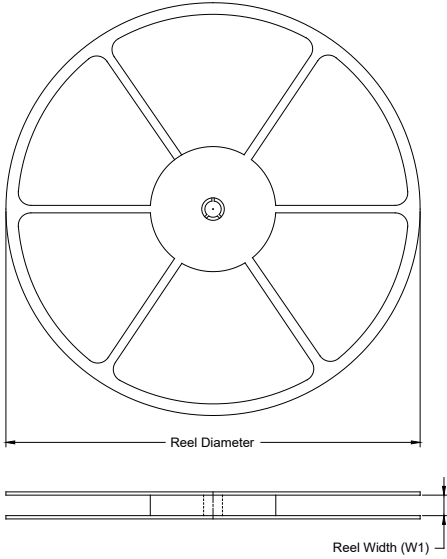

TAPE DIMENSIONS

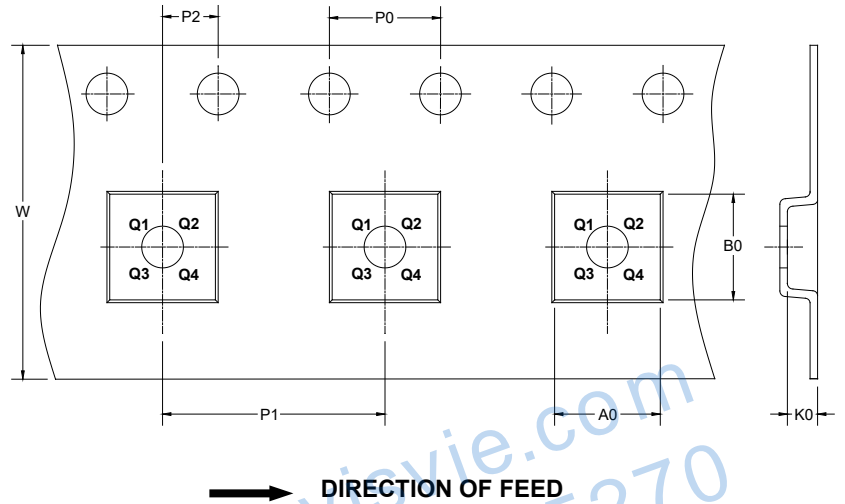

NOTE: The picture is only for reference. Please make the object as the standard.

KEY PARAMETER LIST OF TAPE AND REEL

Package Type	Reel Diameter	Reel Width W1 (mm)	A0 (mm)	B0 (mm)	K0 (mm)	P0 (mm)	P1 (mm)	P2 (mm)	W (mm)	Pin1 Quadrant
SOT-23-5	7"	9.5	3.20	3.20	1.40	4.0	4.0	2.0	8.0	Q3

000001

PACKAGE INFORMATION

CARTON BOX DIMENSIONS



NOTE: The picture is only for reference. Please make the object as the standard.

KEY PARAMETER LIST OF CARTON BOX

Reel Type	Length (mm)	Width (mm)	Height (mm)	Pizza/Carton
7" (Option)	368	227	224	8
7"	442	410	224	18

DD0002

代理商 威尔迈 www.wisvie.com
联系电话 138 2526 5270